

541365

FINAL REPORT

M

**Expert Elicitation on WIPP Waste
Particle Size Distribution(s)
During the 10,000-Year Regulatory
Post-closure Period**

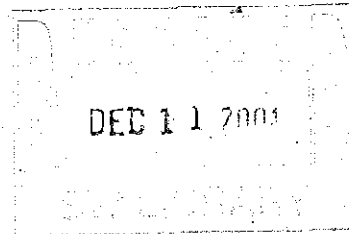

**Prepared by
the Carlsbad Area Office
Technical Assistance Contractor**

**for
the U.S. Department of Energy Carlsbad Area Office**

June 3, 1997

Final Report

Expert Elicitation on WIPP Waste Particle Size Distribution(s) during the 10,000-Year Regulatory Post-Closure Period

June 3, 1997

Executive Summary

A model for the distribution of waste particle sizes at the time and scale of inadvertent human intrusion of the Waste Isolation Pilot Plant (WIPP) transuranic (TRU) waste repository during the 10,000-year regulatory post-closure period has been developed in this report by an Expert Panel. However, definitive information on which to objectively base this model is not available and cannot be obtained. Instead, it must be based on the judgment of qualified and unbiased experts, consistent with all available information. This report documents the process and results of the expert elicitation.

The expert elicitation was administered by the U.S. Department of Energy (DOE) Carlsbad Area Office (CAO) Technical Assistance Contractor (CTAC). The expert elicitation was conducted in response to a request from the U.S. Environmental Protection Agency (EPA) and was conducted in compliance with applicable EPA regulations, and a CAO procedure and plan, and a CTAC desktop instruction.

The expert elicitation process consisted of a third-party elicitor guiding a six-person panel of experts through the process of resolving the technical issue, and included extensive public and other interested party involvement opportunities throughout. The process consisted of the following 11 main steps:

1. *Definition of technical issue(s)* - The technical issue was defined as follows:

What is the conditional probability distribution for the waste particle size frequency distribution (i.e., in terms of percent of the number of particles exceeding a particular size) at a random areal location, at a specified vertical location in the waste room, time and scale, given the initial waste inventory and the predicted extent of each relevant process at that location, time and scale, both just before an intrusion and after tensile failure during a spalling event.
2. *Public notification* - The public and other interested parties were notified in a variety of ways at least 10 days before the elicitation began.
3. *Selection and contracting of experts* - A qualified and unbiased group of six available experts covering the relevant technical areas was identified and selected through a formal process (resumes are attached).
4. *General orientation and elicitation training* - The experts were provided background reading materials before the elicitation, and then were given orientation and probability training on May 5, 1997, when they convened in Carlsbad, New Mexico. The public and other interested parties were invited to observe the orientation and the training (viewgraphs are attached).
5. *Presentation and review of issue(s)* - Technical background (e.g., performance assessment [PA] results and waste particle size information) was then presented by Sandia National Laboratories (SNL) and by the New Mexico Environmental Evaluation Group (EEG) on May 5 and 6,

respectively, to the experts and to observers. The various processes that can affect particle sizes were identified and discussed by the experts. These processes include corrosion of iron-base materials, biodegradation of organics, dissolution of magnesium oxide (MgO) backfill, cementation of various materials by precipitation of dissolved salt, MgO reaction products, and corrosion byproducts, and encapsulation of various materials by salt creep.

6. *Preparation of expert analysis by elicitor* - Consistent with the technical background, as discussed by the experts, the elicitor developed a preliminary decomposition model for discussion.
7. *Discussion of analysis by panel members* - The elicitor presented the preliminary decomposition model to the expert panel and to observers. The expert panel then discussed the model and agreed on appropriate revisions to better reflect their judgment. The public and other interested parties were invited to observe and comment. The model consists of the initial amounts and particle size distributions of six material groups (i.e., 1. iron-base and aluminum-base metals; 2. other metals, inorganics, vitrified, soils and cements; 3. salt fragments; 4. cellulose and solidified organics; 5. rubber and plastics; and 6. magnesium oxide [MgO] backfill) that behave similarly, and the effects of the various reduction and/or aggregation processes on their particle sizes. It was assumed that the materials and processes are independent, and can thus be treated separately and then combined. The particle size distribution model (in EXCEL spreadsheet format) which determines the particle size distribution as a function of the predicted repository conditions (from performance assessment [PA]), is attached.
8. *Elicitation* - Once the decomposition model had been finalized by the expert panel, the panel assessed the various input parameters, guided by the elicitor. The public and other interested parties were invited to observe and comment. The relevant parameters included the amount and initial waste particle size distribution for each material group; the nature of any degradation byproducts and their precipitation/cementation; and the nature of salt encapsulation.
9. *Recomposition* - The elicitor then synthesized and summarized the results of the elicitation, in the form of a set of viewgraphs.
10. *Review and approval, or dissenting opinions provided by the experts* - The expert panel reviewed the viewgraphs and agreed on appropriate revisions to better reflect the panel's judgment. The public and other interested parties were invited to observe and comment. Once satisfied, the experts signed a statement that the resulting set of viewgraphs adequately represented their judgment (viewgraphs and signatures are attached).
11. *Documentation of the process and results* - In addition to this report, which summarizes the process and results and documented procedures and plans, the entire orientation, training, and elicitation process in Carlsbad between May 5 and 9 was transcribed by a court reporter. These transcripts and all the various presentation materials are available in the project file

A draft report was submitted on May 12, 1997, for public and other interested parties review and comment. EEG submitted comments, which were reviewed by the expert panel and incorporated as deemed appropriate by the experts in this final report.

In summation, the results of the expert elicitation consist of a model for defensibly predicting waste particle size distribution as a function of the extent to which various processes have occurred within the repository, as predicted separately by PA. This spreadsheet-based model, which is attached and illustrated schematically in Figure ES-1, can be linked between system PA models and specific

intrusion models, and assumes that the uncertainty in particle size distributions is dominated by the uncertainty in repository conditions. However, the prediction of future repository conditions, the implementation of the particle size distribution model, and the subsequent application of the results of the model in PA are outside the scope of the expert elicitation.

It should be noted that currently, only the average waste mix and conditions in the repository are considered, which might not reflect the variable actual conditions except at large scale. If needed and if supported by PA, the variability at smaller scales could be accommodated by the current particle size distribution model with little additional work.



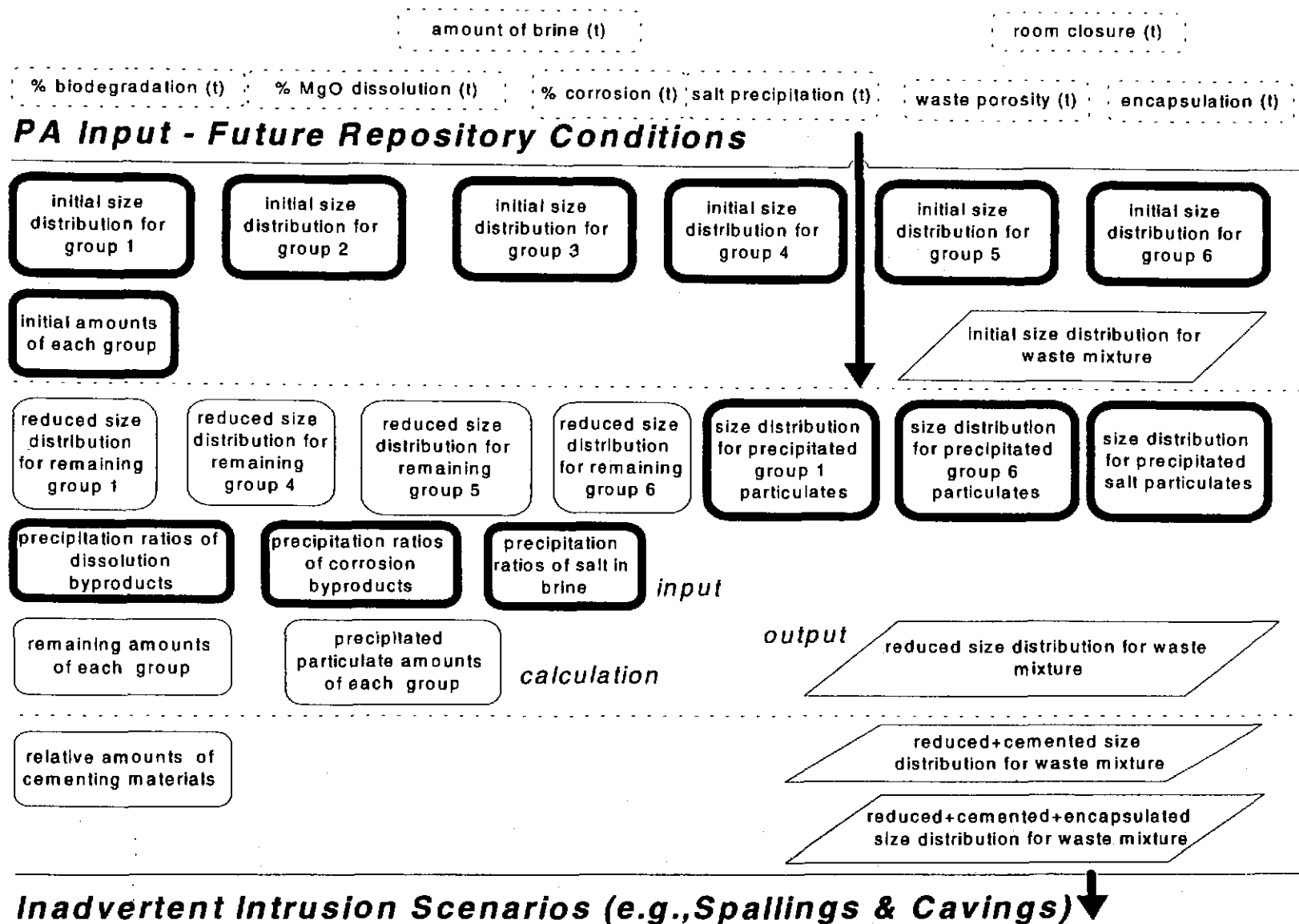

Figure ES-1 Waste Particle Size Model Schematic

Table of Contents

Executive Summary.....	i
Acronyms.....	viii
1. Introduction.....	1
1.1 Purpose.....	1
1.2 Scope.....	2
1.3 Institutional Background.....	3
1.4 Format.....	7
2. Technical Background.....	7
2.1 Materials.....	9
2.2 Processes.....	10
2.2.1 Crushing.....	10
2.2.2 Corrosion.....	10
2.2.3 Biodegradation.....	11
2.2.4 Dissolution/Precipitation/Cementation.....	11
2.2.5 Encapsulation.....	11
2.2.6 Fragmentation.....	11
2.3 Performance Assessment.....	12
2.3.1 System Performance.....	12
2.3.2 Inadvertent Intrusion.....	13
2.3.2.1 Spalling.....	13
2.3.2.2 Caving.....	14
2.3.3 Summary.....	14
2.4 Waste Particle Diameters.....	14
2.4.1 Variability.....	15
2.4.2 Uncertainty.....	15
2.4.2.1 Variability among Subpopulations.....	16
2.4.2.2 Scale-Dependent Variability.....	16
2.4.2.3 Spatial Correlation.....	17
2.4.3 Summary.....	25
3. Technical Approach.....	27
3.1 Definition of Technical Issue(s).....	28
3.2 Public Notification.....	28
3.3 Selection and Contracting of Experts.....	29
3.4 General Orientation and Elicitation Training of Experts.....	30
3.5 Presentation and Review of Issue(s).....	30
3.6 Preparation of Expert Analysis by Elicitor.....	32
3.7 Discussion of Analysis by Panel Members.....	32
3.8 Elicitation.....	34
3.9 Recomposition.....	34
3.10 Review and Approval or Dissenting Opinions Provided by the Experts.....	34
3.11 Documentation of the Process and Results.....	39
4. Decomposition Model.....	39
4.1 Materials and Processes.....	39
4.1.1 Types of Processes.....	40
4.1.2 Material Groups.....	41
4.1.3 Modeled Processes.....	42
4.1.3.1 Corrosion.....	42
4.1.3.2 Biodegradation.....	42

4.1.3.3 Dissolution	42
4.1.3.4 Cementation	42
4.1.3.5 Encapsulation	42
4.2 Algorithms	43
4.3 Model Parameters	43
4.4 Variability and Uncertainty	44
4.5 Model Limitations	45
5. Parameter Assessments	54
5.1 Initial Particle Size Population	54
5.1.1 Iron- and Aluminum-Base Metal/Alloys	54
5.1.2 Other Metals/Inorganic/Vitrified/Soils/Cements/Solidified Inorganics	55
5.1.3 Salt (rock)	55
5.1.4 Cellulosics/Solidified Organics	55
5.1.5 Rubber/Plastics	56
5.1.6 MgO Backfill	57
5.2 Effects of Processes	57
5.3 Amounts and Distribution of Materials	58
5.4 Repository Conditions	58
6. Results	67
6.1 Distribution of Particle Sizes	67
6.2 Discussion	68
6.2.1 Assessment	68
6.2.2 Reliability	69
6.2.2.1 Internal Consistency	69
6.2.2.2 External Consistency	70
6.2.2.3 Model Uncertainty	70
6.2.2.4 Additional Information	70
6.2.3 Conclusions	71
7. Conclusions	73
8. References	74
9. Review and Approval	75

List of Tables

Table 2-1 Materials	9
Table 3-1 Expert Elicitation Materials	26
Table 3-2 Expert Panel	29
Table 3-3 Key Background Reading Material	31
Table 4-1 Effects of Processes on Materials	40
Table 5-1 Initial Particle Size Distribution - Fe- and Al-base metals	54
Table 5-2 Initial Particle Size Distribution (e.g., other metals, soils)	55
Table 5-3 Initial Particle Size Distribution (cellulosics/solidified organics)	56
Table 5-4 Initial Particle Size Distribution (rubber/plastics)	57
Table 5-5 Amount and Distribution of Material	58

List of Figures

Figure ES-1 Waste Particle Size Model Schematic	iv
Figure 1-1 WIPP Location Map (from DOE, 1996a)	5
Figure 1-2 WIPP Facilities (from DOE, 1996a)	6
Figure 2-1 Influence Diagram for Particle Size Distribution	18
Figure 2-2 Population of Waste Particle Diameters	19
Figure 2-3 Statistical Description of Population of Waste Particle Diameters	20
Figure 2-4 Uncertainty in Specific Population of Waste Particle Diameters	21
Figure 2-5 Variability of Waste Particle Size Populations	22
Figure 2-6 Scale-Dependent Variability of Waste Particle Size Populations	23
Figure 2-7 Spatial Correlation in Particle Size Populations	24
Figure 3-1 Expert Elicitation Process	35
Figure 3-2 Waste Particle Size	36
Figure 3-3 Probability Wheel	37
Figure 3-4 Integrated Construction of Probability Distribution	38
Figure 4-1 Example - Initial Distribution	46
Figure 4-2 Example - Pervasive Reduction	47
Figure 4-3 Example - Selected Reduction	48
Figure 4-4 Example - Aggregation	49
Figure 4-5 Prediction of Particle Size - One Material and One Process	50
Figure 4-6 Prediction of Particle Size - One Material and Multiple Processes	51
Figure 4-7 Prediction of Particle Size - Multiple Materials and Processes	52
Figure 4-8 Decomposition Model Schematic	53
Figure 5-1 Initial Particle Size Population - Group 1, Fe- and Al-Base Metals	60
Figure 5-2 Initial Particle Size Population - Group 2, Other Metals/Soils/etc	61
Figure 5-3 Initial Particle Size Population - Group 3, Salt	62
Figure 5-4 Initial Particle Size Population - Group 4, Cellulosics/Solidified Organics	63
Figure 5-5 Initial Particle Size Population - Group 5, Rubber/Plastics	64
Figure 5-6 Precipitation	65
Figure 5-7 Cementation	66
Figure 6-1 Example Results for Distribution of Waste Particle Sizes	72

List of Attachments

- I Letter from E.R. Trovato (U.S. EPA) to A. Alm (U.S. DOE) dated March 19, 1997
- II Letter from E.R. Trovato (U.S. EPA) to G. Dials (U.S. DOE) dated April 25, 1997
- III Letter from Carol M. Browner (U.S. DOE) to Federico Peña, dated May 16, 1997

List of Appendices

- A Orientation and Training Materials
- B Decomposition Model
- C Parameter Assessments
- D Resumes



ACRONYMS



BID	Background Information Document
CAO	Carlsbad Area Office
CAG	Compliance Application Guidance
CCA	Compliance Certification Application
CCDF	Complementary cumulative distribution function
CDF	Cumulating distribution function
CFR	Code of Federal Regulations
CTAC	CAO Technical Assistance Contractor
DOE	U.S. Department of Energy
EEG	New Mexico Environmental Evaluation Group
EPA	U.S. Environmental Protection Agency
FR	Federal Register
HEPA	High efficiency particulate air
HDPE	High density polyethylene
INEEL	Idaho National Engineering and Environmental Laboratory
LWA	Land Withdrawal Act of 1992
MgO	Magnesium oxide
MPa	Mega Pascals
NRC	U.S. Nuclear Regulatory Commission
OH	Overhead (slide)
OP	Overpack
ORC	Office of Regulatory Compliance
PA	Performance assessment
RH	Remote handled
SNL	Sandia National Laboratories
SWB	Standard waste box
TP	Team Procedure (Carlsbad Area Office)
TRU	Transuranic
WIPP	Waste Isolation Pilot Plant

1. Introduction

1.1 Purpose

This report describes the process that the U.S. Department of Energy (DOE) Carlsbad Area Office (CAO) Technical Assistance Contractor (CTAC) used to elicit expert judgment on a particular issue pursuant to CAO Team Procedure (TP) 10.6, Rev. 0 (Expert Judgment) (DOE, 1997a), the CAO Expert Panel Elicitation Plan, Rev. 2 (DOE, 1997b), and CTAC Experimental Programs desktop instruction CTAC/EP-DI 1, Rev. 0 (CTAC, 1997), and the results obtained.

A model input variable related to the distribution of particle diameters in degraded Waste Isolation Pilot Plant (WIPP) transuranic (TRU) waste was used in the WIPP Compliance Certification Application (CCA) model (DOE, 1996a) to calculate the volume of spall releases. Spall (and cuttings, cavings, and brine) releases may occur as inadvertent human intrusions (boreholes) reach or penetrate the waste emplaced in the WIPP repository during the 10,000-year period following the closure of the WIPP. Because the distribution of particle diameters affects the quantity of material released, and because the particle diameters are uncertain and cannot be estimated directly based on available data, the U.S. Environmental Protection Agency (EPA) requested in letters dated March 19 and April 25, 1997 (Attachments I and II), that the waste particle diameter used in the CCA be based on an elicitation of expert judgment. Although only a single particle diameter, as opposed to the entire population, was used in each realization of the spillings model, the uncertainty in the actual population of particle diameters is being assessed because this information is more informative, can be used to construct a mean of a population for use in the CCA model, and is potentially applicable for use in other models (e.g., cavings and transport of particles up the intrusion borehole).

1.2 Scope

This report documents the process and results of the expert elicitation on waste particle diameters at the time of inadvertent human intrusion. In the absence of definitive direct data, resolution of the technical issue must be done by elicitation of judgment of a qualified and unbiased expert panel, consistent with all available information. It should be recognized that the probabilities that were assessed reflect the experts' collective judgment in interpreting all the available information, considering the relevance of various types of information (e.g., representativeness, biases). Data do not replace judgment, but instead constrain the results. Conceptually, given enough data, the results can be constrained to eliminate alternative interpretations. However, this is generally not possible when extrapolating past information into the future. Statistical analysis of the available data in such cases is useful but not sufficient.

Probability distributions are needed for the population of particle sizes of WIPP waste disposal room contents that could potentially become part of an inadvertent release to the surface as a function of time. A particle that is "potentially" spallable or cavable is a particle available for possible transport by fast-moving gas or by drilling actions, respectively. These particles are "potentially" spallable or cavable because the processes of transport by flowing gas or by drilling action to and up the borehole are not to be considered in the development of these distributions. The only uncertainty being characterized is the size of particles or aggregates of cemented particles at the time of inadvertent intrusion, resulting from consideration of the initial particle size distribution at the time of closure and the processes occurring in the waste disposal area up to that time. Conditions, processes, and events that may occur in the waste disposal rooms and that may affect particle size include the following:

- 
- the form and relative proportions of the materials initially emplaced (e.g., waste, waste containers, and magnesium oxide [MgO] backfill);
 - compaction of filled disposal rooms caused by creep closure;
 - encapsulation of materials in disposal rooms, especially near the boundary of the room, by salt creep;
 - brine inflow;
 - phase changes associated with hydration of MgO backfill;
 - the uncertain extent of anoxic corrosion of iron (Fe)-base and aluminum (Al)-base metals;
 - the uncertain extent of degradation of cellulose and solidified organics;
 - the uncertain extent of degradation of plastics and rubber; and
 - cementation of waste by precipitated halite, anoxic corrosion products, and phases created by MgO hydration and/or reaction with carbon dioxide.

Waste particles could be further affected by processes that occur during inadvertent intrusion, e.g., erosion/fragmentation of waste by gas pressure gradients created near the borehole or by drilling actions.

Not only is the uncertainty in the occurrence and extent of the above conditions, processes, and events important, but also their variability at various scales across the repository. Because the extent of various processes (e.g., microbial degradation of cellulose, plastics, and rubber) is very uncertain and is outside the scope of this elicitation, conditional probability distributions will be described as a function of the extent of such processes, in the form of a model.

As noted above, the prediction of future repository conditions is outside the scope of this elicitation. Moreover, the implementation of the particle size distribution model and the subsequent application of the results of the model in performance assessment (PA) also are outside the scope of this elicitation. Lastly, although the radioactivity associated with the particles is important in estimating release and subsequent exposures, this is outside the scope of this study.

To enhance the defensibility of the results of the elicitation process, the process actively encouraged public and other interested party participation and required adequate documentation. The public and other interested parties were invited to: 1) submit information and/or interpretations which the group of experts would consider; and 2) observe and comment on the elicitation process and results. To allow the process to be replicated, it was thoroughly documented in accordance with applicable standards.

1.3 Institutional Background

Public Law 102-579, commonly referred to as the WIPP Land Withdrawal Act of 1992 (LWA), sets aside a land parcel in the state of New Mexico from public use to be used for safe disposal of TRU waste (Figure 1-1). It also directs the DOE to develop and safely operate a deep geologic repository for TRU waste at the WIPP site in compliance with applicable regulations promulgated by the EPA.

TRU waste consists of inorganic and organic solid and solidified waste materials that are contaminated with both transuranic and hazardous constituents. The main EPA regulations that apply to this waste are Code of Federal Regulations, Title 40, Part 191 (40 CFR 191), 40 CFR 194, 40 CFR 261, 40 CFR 264, and 40 CFR 268. The 40 CFR 191 and 40 CFR 194 regulations pertain to the radioactive constituents of the TRU waste, whereas 40 CFR 261, 40 CFR 264, and 40 CFR 268 pertain to the non-radioactive hazardous constituents.

The DOE has characterized the WIPP site since 1974. The surface and a portion of the subsurface facilities needed to commence the disposal of TRU waste at the WIPP site were completed in 1988 (Figure 1-2). The DOE submitted the CCA for the WIPP site in October 1996 to show compliance with 40 CFR 191 (and the related criteria regulation 40 CFR 194, which was promulgated by the EPA in February 1996). On March 19, 1997 (Attachment I) the EPA advised the DOE that 13 of the parameters used in the CCA PA to show compliance with 40 CFR 191 and 40 CFR 194 lacked supporting evidence. On April 25, 1997 (Attachment II) the EPA advised the DOE that it had received adequate supporting information on 12 of the 13 parameters listed in the letter of March 19, 1997. The EPA also advised the DOE that it would accept expert judgment on the remaining parameter, the waste particle diameter(s), during the 10,000-year post-closure period. The EPA informed the Secretary of Energy on May 16, 1997 (Attachment III) that the EPA had received "the full application", per the August 7, 1996 amendment to the LWA, and the EPA is currently evaluating the CCA. According to the LWA, as amended, the EPA has until May 16, 1998 (i.e., one year) to either accept or reject the CCA.

1.4 Format

This report summarizes the process and the results of an expert panel elicitation administered by CTAC on the WIPP waste particle diameter(s) during the 10,000-year regulatory period. This report consists of the following sections:

- *Technical Background* (Section 2) presents the relevant technical background regarding the potential types of materials and post-closure processes occurring in the repository. PA and the nature and context of the technical issue are also discussed. This formed the basis for subsequent assessments, as described in the remainder of the report.
- *Technical Approach* (Section 3) presents the approach used in this study to develop estimates of the waste particle diameters at the time of inadvertent human intrusion, consistent with the technical background presented in Section 2. This consists of developing a decomposition model for the issue, subjectively assessing the parameters that quantify the model, and implementing the model with those parameters, as described separately in the following sections. Orientation and training materials and resumes for the expert panel manager, the selection committee members, the elicitor and the subject-matter experts are presented in Appendices A and D, respectively.
- *Decomposition Model* (Section 4) presents the model for decomposing the issue of future waste particle diameters. This consists first of concepts and then parameters and algorithms which quantify the concepts and, when combined, produce a reasonable estimate of waste particle diameters at the time of inadvertent human intrusion. The quantitative model is documented in Appendix B and the concepts developed by the experts are documented in Appendix C.
- *Parameter Assessments* (Section 5) describes the information available regarding each model parameter defined in Section 4, summarizes the rationale used by the experts in assessing each

parameter, and presents the experts' assessment of each parameter. The experts' assessments are documented in Appendix C.

- *Results* (Section 6) discusses the types of results of the model presented in Section 4, when implemented with the parameter assessments presented in Section 5 and the results of PA. The assessment of waste particle diameters at the time of inadvertent human intrusion is presented in a format compatible with PA, as discussed in Section 2.
- *Conclusions* (Section 7) presents conclusions regarding the process and results of the expert elicitation on waste particle diameters at the time of inadvertent human intrusion, including potential limitations.
- *References* (Section 8) lists the relevant documents cited in the report.
- *Review and Approval* (Section 9) provides confirmation by signature that each expert panel member has reviewed and approved the Executive Summary and Sections 1 through 9 of this report.

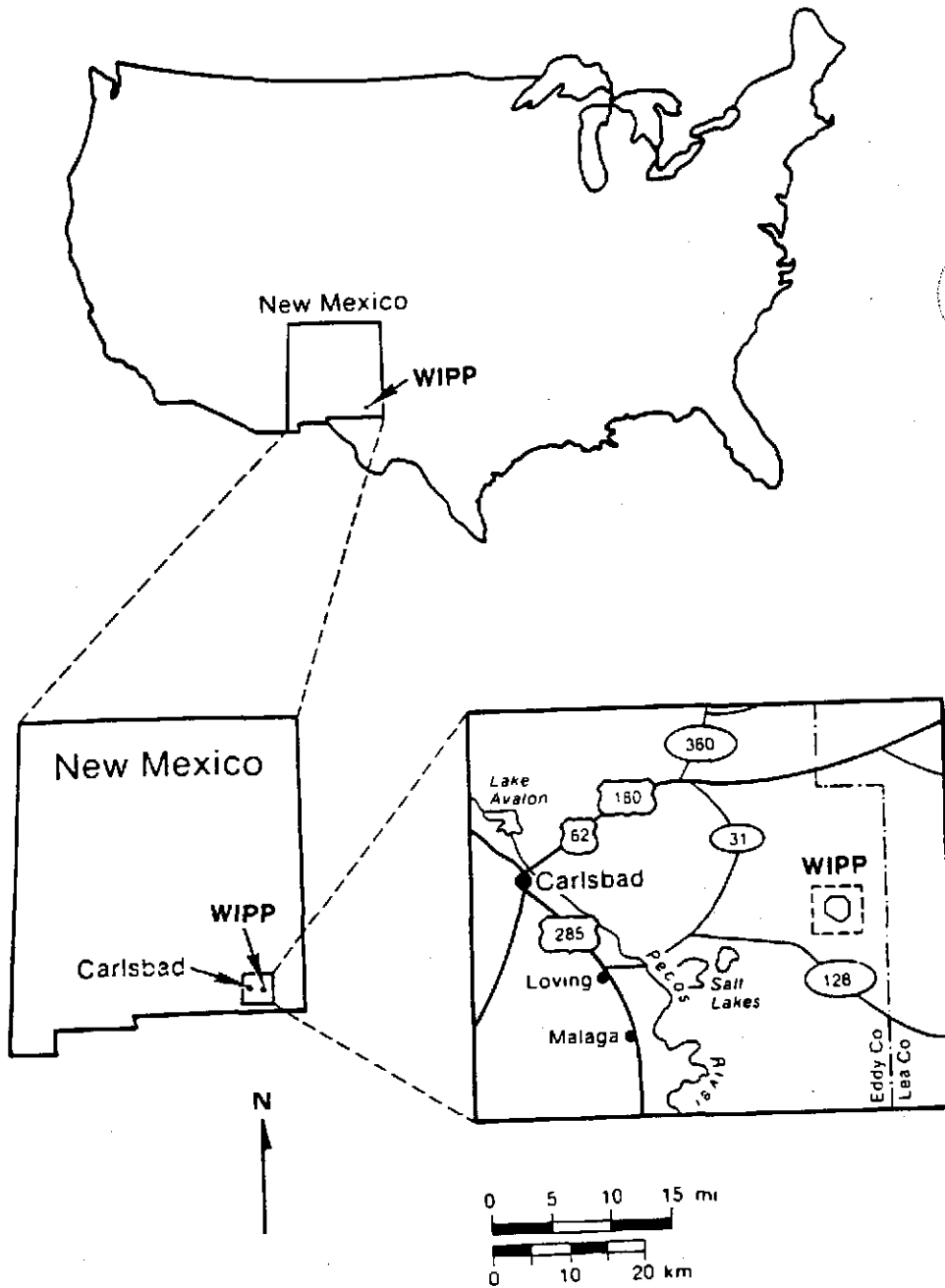

Figure 1-1 WIPP Location Map (from DOE, 1996a)

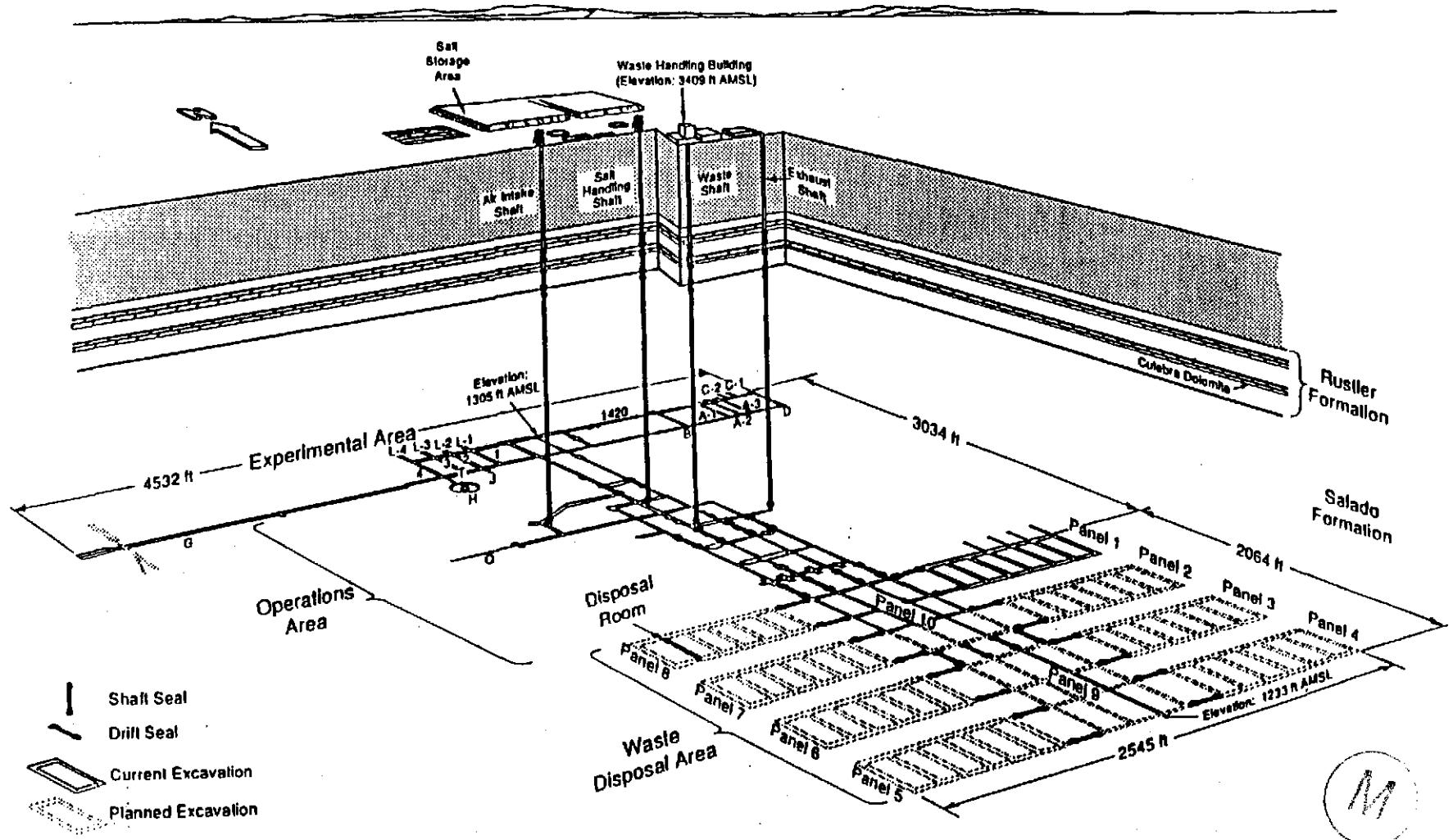

Figure 1-2 WIPP Facilities (from DOE, 1996a)

Information Only

2. Technical Background

TRU waste (see Appendix A - General Orientation), along with other materials (e.g., packaging and backfill), is scheduled to be emplaced in a deep geological repository at the WIPP site (Figures 1-1 and 1-2). These materials may be subject to various processes over the 10,000 years following the closure of the repository, which may change their physical/chemical characteristics, including their particle size. The physical/chemical characteristics of the materials, in turn, may affect how the repository performs with respect to regulatory criteria. As discussed in Section 1.1, waste particle diameters are of particular interest. These aspects are discussed separately in the following subsections.

2.1 Materials

Various materials are scheduled to be emplaced in the WIPP repository. Each material comprises a percentage of the total quantity of materials within the repository, has an initial particle size distribution, and may be concentrated at various scales within the repository.

WIPP TRU waste comprises materials contaminated with transuranic radionuclides during activities related to nuclear weapons production since 1970. The waste contains, for example, packing materials, tools, protective clothing, manufacturing and laboratory equipment, and contaminated liquids solidified with cements. The waste is placed in 55-gallon, plastic-lined drums, larger standard waste boxes (SWBs), or canisters for temporary storage, transportation, and disposal.

The TRU waste will be emplaced in disposal rooms mined into the approximately 600-m thick Salado Formation halite (rock salt), approximately 655 m (2150 feet) below the ground surface (Figure 1-2). The drums and boxes of waste will be stacked in disposal rooms that are approximately 4 m high, 10 m wide, and 91 m long. The waste containers will be emplaced with bags of magnesium oxide (MgO) pellets as backfill that will tend to stabilize the chemical conditions in the disposal rooms. Remote handled (RH) TRU waste contained in canisters will be placed horizontally in the walls of the repository without additional MgO backfill.

Hence, the materials that will be emplaced in the repository as waste, packaging and backfill, include the following (DOE, 1996b):

- *iron-base metal/alloys* - includes iron and steel alloys in the waste, and iron-base metallic phase associated with vitrification; are mixed throughout the repository; steel packaging and steel plug are considered separately.
- *aluminum-base metal/alloys* - includes aluminum or aluminum-base alloys in waste materials; are mixed throughout the repository.
- *other metal/alloys* - includes all other metals found in waste materials (e.g., copper, lead, zirconium, tantalum, lead portion of lead rubber glove/aprons); are mixed throughout the repository; lead packaging is considered separately.
- *other inorganic materials* - includes inorganic non-metal waste materials (e.g., concrete, glass, firebrick, ceramics, graphite, sand, and inorganic sorbents); are mixed throughout the repository.

- *vitrified* - includes waste that has been melted or fused at high temperature with glass-forming additives (e.g., soil or silica) in appropriate proportions to result in a homogeneous glass-like matrix; are in 7-drum packs; any unoxidized metallic phases are considered as iron-base metal/alloys.
- *cellulosics* - includes materials generally derived from high polymer plant carbohydrates (e.g., paper, cardboard, kimwipes, wood, cellophane, cloth); are mixed throughout the repository.
- *rubber* - includes natural or manmade elastic latex materials (e.g., Hypalon®, neoprene, surgical gloves, rubber part of leaded-rubber gloves); are mixed throughout the repository.
- *plastics* - includes generally manmade materials, often derived from petroleum feedstock (e.g., polyethylene, polyvinyl chloride, Lucite®, Teflon); are mixed throughout the repository; plastic packaging is considered separately.
- *solidified inorganic materials* - includes any homogeneous materials consisting of sludge or aqueous base liquids that are solidified with cement, Envirostone®, or other solidification agents (e.g., wastewater treatment sludge, cemented aqueous liquids, and inorganic particulates); are in 7-drum packs; cement used as part of solidification process is considered separately.
- *solidified organic materials* - includes cemented organic resins, solidified organic liquids, and sludges; are in 7-drum packs.
- *cement (solidified)* - includes cement used in solidifying liquids, particulates, and sludges; are mixed throughout the repository.
- *soils* - includes generally naturally occurring soils contaminated with inorganic radioactive waste materials; are in 7-drum packs.
- *steel packaging* - includes containers (e.g., drums, boxes, and canisters); are in all waste containers; steel in waste and steel plug packaging are considered separately.
- *plastics packaging* - are in all waste containers; plastics in waste are considered separately.
- *lead packaging* - includes lead shielding in a remote handled (RH) canister; are located in room walls; lead in waste is considered separately.
- *steel plug* - are located in room walls; steel in waste and steel non-plug packaging are considered separately.
- *MgO backfill* - includes pellets; are primarily at top and sides of waste room.

In addition to the above materials emplaced in the repository, salt fragments may separate from the roof and walls and mix with the waste, especially near the roof.

The various materials in the WIPP repository and their relevant initial characteristics at the end of the 100-year active institutional control period are summarized in Table 2-1. The relevant initial characteristics of each material include:

- *initial amount* - The percentage of the initial total weight of all material emplaced within WIPP.

- *spatial distribution* - The variability in concentration throughout the repository (e.g., localized pockets or uniformly distributed) at various scales.

Table 2-1 Materials

Material	Expected Amount (% Total Wt of Materials placed in Repository)²	Spatial Distribution
iron-base metal/alloys	12.6	throughout
aluminum-base metal/alloys	1.3	throughout
other metal/alloys	5.6	throughout
other inorganic materials	2.4	throughout
vitrified	4.0	in 7-packs
cellulosics	4.0	throughout
rubber	0.7	throughout
plastics	2.5	throughout
solidified inorganic materials	4.0	in 7-packs
solidified organic material	0.4	in 7-packs
cement (solidified)	3.7	throughout
soils	3.2	in 7-packs
steel packaging	11.4	all waste containers
plastics packaging	1.9	all waste containers
lead packaging	1.4	with RH in room walls
steel plug	6.5	with RH in room walls
MgO backfill	34.5	top and sides of room
salt	Note 1	top of room

- Note: 1. The amount of salt fragments was estimated, as discussed in Section 5.
 2. The amounts of each material will vary among locations as a function of scale, and will not equal the average repository-wide average amounts except at large scale, as discussed in Section 2.4.

It is conceivable that some of the above materials will degrade in similar ways due to the processes that will occur in the WIPP repository. If so, they can be combined and treated as one type of material. This is discussed further as part of the decomposition model presented in Section 4.

2.2 Processes

The materials in the repository may be subject to various processes over the 10,000 years following closure. These processes may affect the physical/chemical nature of the materials, and include creep closure, brine inflow from the surrounding salt formation, chemical reactions that generate gas by anoxic corrosion, possible gas-generating microbial degradation of cellulosic, plastics, and rubber, cementation by precipitated phases, and encapsulation by localized salt creep. Radiolytic decomposition can also occur, although it is anticipated to be relatively insignificant in comparison to the other processes. As previously noted, erosion and/or tensile failure during borehole intrusion can also occur. These processes are summarized in Figure 2-1, and are described in the following subsections (DOE, 1997b). They are described in more detail in Section 4 in terms of how they are modeled.

2.2.1 Crushing

WIPP disposal rooms reduce in volume as the surrounding halite (salt) creeps into the excavation, depending on the pressure inside the room. Creep closure will tend to crush the waste containers, exposing their contents to the conditions in the disposal rooms to a variable extent, depending on how the individual waste containers deform and liners rupture. Most of the creep closure occurs within 100 years of waste emplacement, and will compact rooms and contents to heights less than 2 m. Inward-creeping halite may also encapsulate materials, especially near the boundaries of waste stacks as salt crystals deform, as discussed separately in Section 2.2.5. The crushing of waste containers and waste (as well as encapsulation of waste near room boundaries) may affect the overall distribution of particle diameters. Crushing by creep closure may also create mechanical bonding of waste as some components deform into interlocking shapes, like puzzle pieces, which occurs at many size scales.

2.2.2 Corrosion

A small quantity of residual liquid (less than one percent) is present initially in the emplaced waste, and inflow of brine into the repository is expected. Metal in the waste, predominantly steel, will react anoxically with water to generate hydrogen gas (increasing the gas pressure within the disposal room), and iron hydroxides. Due to the abundance of steel in the waste and containers, anoxic corrosion of steel has been determined to be the most important corrosion reaction and is the only corrosion reaction calculated in performance assessment models. The quantity of steel corroded, as well as the duration of anoxic corrosion, is uncertain, depending on other conditions. For example, corrosion may stop early because brine is not available to drive the reaction, or it may proceed for the entire regulatory period. However, it is very unlikely that anoxic corrosion will consume all the steel initially present. Anoxic corrosion is a change of chemical phase that affects the volume and size of the steel in the repository, which is a large component of the initial mass. Thus, it may affect the overall distribution of particle diameters in the waste both by chemical breakdown of steel, and as discussed separately in Section 2.2.4 by iron hydroxides bonding particles of waste into larger aggregates.

2.2.3 Biodegradation

Although microbes will be present in the emplaced waste, it is uncertain whether microbes will be viable in the repository environment. For example, in the CCA PA calculations, the probability that microbes would be viable was assessed to be 50%. It is also uncertain which components of the waste may be suitable as microbial substrates. For example, in the CCA PA calculations, if microbes are viable, the probability that cellulosic components of the waste are microbial substrates was assessed to be 100%, whereas the probability that plastic and rubber components are microbial substrates was assessed to be 50%. In the CCA, the simplifying assumption was made that all microbial substrates are degraded by microbes at the same rate. Although conservative, this assumption is likely unrealistic because the variability in the composition of plastics and rubber indicates that perhaps some of these components might not degrade at all. However, assuming uniform degradation (if it occurs at all) results in rapid reactions and, in general, complete degradation of all microbial substrates within 2,000 years after repository closure (DOE, 1996a). If it occurs, the microbial degradation of substrates may alter particle diameters. Biodegradation of organic materials will also result in biomass and other byproducts as well as gas.

2.2.4 Dissolution/Precipitation/Cementation

As discussed in Section 2.2.2, corrosion of metals will produce iron hydroxides. These iron hydroxides will precipitate out, either as free particles or as cementing agents.

MgO will be emplaced as backfill surrounding the waste in the repository to maintain chemical conditions of relatively low actinide solubility. Emplaced MgO will hydrate as brine enters the repository, changing chemical phase, and react with the carbon dioxide (CO₂) generated if microbes are viable, changing phase again. MgO emplaced with the waste is a large fraction (about 1/3) of the initial mass in the repository. Thus, the chemical compounds formed as MgO hydrates and reacts with CO₂ will affect the distribution of particle diameters and the bonding of waste particles.

Anoxic corrosion and the hydration of MgO consume water in brine, causing (among other phases) the precipitation of salt crystals. Depending on its location and extent, precipitation of salt crystals may also bond particles together.

2.2.5 Encapsulation

As discussed in Section 2.2.1, salt will creep into the excavation, depending on the pressure inside the room (e.g., gas pressure or due to compression of the waste). At some point (e.g., once the waste has been sufficiently compressed), the pressure inside the room will be high enough to stop overall room closure. However, at a smaller scale, the salt may not experience such pressure in some locations (e.g., where there are voids in the waste) and the salt may continue to "flow" locally into the voids, encapsulating waste particles. Such encapsulation occurs mainly near the salt-waste boundary. If the degraded waste is also relatively plastic, it may also flow into voids, possibly reducing the amount of waste for salt encapsulation. However, this will occur throughout the waste, as opposed to the salt-waste boundary where encapsulation occurs, so that its effect on reducing encapsulation might not be significant.

2.2.6 Fragmentation

As discussed in Section 2.3.2, the waste may be subject to significant stresses during inadvertent intrusion. For example, the waste may experience tensile or shear failure due to pressure gradients or the action of drilling fluids once a borehole penetrates the room. If such stresses exceed the strength of individual particles, as defined in Section 3.1, they may break apart, thus affecting their particle size. Obviously, the mechanical action of the drill bit is intended to grind up particles in its path to sufficient size to remove them from the borehole, and thus also affects particle sizes; this grinding process, however, is outside the scope of this elicitation.

2.3 Performance Assessment

PA of the WIPP disposal system involves estimating the extent to which each of the above processes occurs as a function of time (e.g., the time history of creep closure of the emplacement room), as well as waste releases for various scenarios as a function of time (e.g., inadvertent human intrusion) (DOE, 1996a).

2.3.1 System Performance

In probabilistic PA, the future performance of the WIPP disposal system is quantified by the application of models incorporating the uncertainties about the processes and properties of the WIPP disposal system, the uncertainties in future human actions, and assumptions specified by EPA. The panel discussed the following processes:

- *crushing/compaction* is determined from room closure;
- *corrosion* is determined from brine volume and competing MgO dissolution;
- *biodegradation* is determined from brine volume, as affected by corrosion and MgO dissolution;
- *dissolution* is determined from brine volume and competing corrosion;
- *cementation* is determined from corrosion, MgO dissolution and salt precipitation;
- *encapsulation* is determined from salt creep and room closure; and
- *fragmentation* is determined for spalling events.

Although there may be insignificant variability in these processes among rooms prior to intrusion, there may be significant variability in all processes at a smaller scale. It should be noted that currently PA does not consider MgO dissolution (DOE, 1996a), fragmentation, cementation, encapsulation, or small scale variability in processes.

Uncertainty is incorporated in performance assessments through the use of Monte-Carlo sampling procedures. Uncertainty in input variables is defined based on knowledge gained by characterization of the disposal system (including the waste), the definitions of parameters used in models, and by consideration of regulatory criteria. The Monte-Carlo sampling procedure propagates many "vectors" of sampled values for uncertain input variables through a system of linked computer models, leading to a probabilistic description of the future performance of the WIPP repository. The regulatory period, defined by the EPA in 40 CFR 191, is the 10,000 years following closure of the repository. Thus, PA develops a probabilistic description of the behavior of the WIPP disposal system in a regulatory context from closure until 10,000 years following closure.

2.3.2 Inadvertent Intrusion

Current PA calculations indicate that the most important uncertainty in the future performance of the WIPP disposal system is the question of whether, when, and how many times humans will inadvertently drill into the waste while exploring for or developing natural resources in the future. The method for determining the frequency of occurrence of such events, called "inadvertent intrusions," has been specified by the EPA in 40 CFR 194. By the EPA's method, it is extremely likely that multiple inadvertent intrusions will occur during the 10,000-year post closure period.

Each inadvertent intrusion into the repository waste may cause a release of particulate waste material to the surface. This particulate waste material is separated from the remaining material by three processes: cuttings; cavings; and spalling. Cuttings and cavings, which are the waste materials removed by the action of the drill bit and the circulating mud, respectively, may occur with an inadvertent intrusion into

the waste. Spalling, which is the removal of particulate material as high-pressure gas in the repository causes blowout of the drilling mud and erosion and/or tensile failure of the waste, may occur if certain precursor conditions occur. Spallings and cavings are discussed below since they may lead to fragmentation; cuttings is outside the scope of this elicitation and not discussed further.



2.3.2.1 Spalling

Spalling can only occur if the gas pressure at the time of intrusion is large enough (greater than 8 mega Pascals [MPa]) to expel the drilling mud from the borehole (SNL, 1997a). In the CCA, the conservative assumption was made that all intrusions with disposal room gas pressures greater than 8 MPa will cause a spalling release due to erosion of the waste particles (which were assumed to have a minimal cementation strength of 1 psi). Hence, a model input variable related to the distribution of particle diameters in degraded WIPP waste was used in the CCA model to calculate the volume of spall releases. However, if the degraded waste has tensile strength, particles in the waste can become part of a spalling release only if the tensile strength of their bonds to the remaining waste is exceeded. For this to occur, the gas pressure gradient between the waste and the base of the borehole must be large enough to cause tensile failure of those bonds.

Data collected from strength experiments on surrogates for degraded waste show that room contents will generally have cohesive and tensile strength (SNL, 1997a). These experiments were conducted assuming that the waste components will be relatively well mixed, as well as degraded. The experimental data on the homogeneous surrogates show that, sometime in the future when the degradation processes have occurred, disposal room contents will generally behave like a poorly-cemented, weak rock rather than a pile of loose, discrete granules. It should be noted, however, that the waste may actually be segregated at the scale of individual waste packages. Hence, there may be small pockets of weak materials which behave very differently from the homogeneous surrogates, especially in the near future before degradation processes have progressed very far.

Characterization of the tensile failure process shows that for tensile strengths similar to those of the surrogate materials (SNL, 1997a): (1) pressures in the waste panel must be greater than at least 12 MPa for even very small volumes of waste to experience tensile failure, and greater than 14 MPa for moderate volumes of waste to experience tensile failure, compared to the spall volumes used in the CCA; and (2) the process of tensile failure will take place within less than a second of the time the drill bit penetrates the top of the disposal room. Within the volume of waste subjected to tensile failure, a variety of particle diameters may be created, depending on the diameters of individual particles, bonding of particles, and the process of tensile failure which may fragment the waste. This was not accounted for in the Spallings model used in the WIPP CCA, which instead conservatively assumed that the entire volume was released to the ground surface.

2.3.2.2 Caving

As described in Attachment A to the Appendix CUTTINGS of the CCA (DOE, 1996a), the conceptual model for the caving process used by DOE in the CCA conservatively assumes hydraulic erosion of waste material from the walls of the borehole via drill mud circulation, and specifically takes no credit for the chemical and very little credit for the mechanical strength of the waste material; it is assumed that only the material shear strength affects the process of hydraulic erosion of the drill hole walls, and that the tensile strength of the material available to erode is negligible. It calculates the size of the eroded cavity based on existing drilling practices (including drill stem rotation rate, bit diameter, and properties

of the drilling fluid) and a single-parameter representation of the shear strength of the waste (parameter name: TAUFAIL). In the CCA, DOE sampled across a distribution for the value of TAUFAIL, which was based on a very conservative analogue of the final waste form (for which experimental measurements of the material strength were available). This conservative analogue material was San Francisco Bay mud (a soil mixture composed of about equal amounts of clay and silt with traces of sand and some organic material). The measurements of shear strength were made in an open flume with recirculating water of ocean salinity, and resulted in a range of scouring stress from about 0.05 to 10 Pascal.

EPA has requested that DOE perform tests of parameter variability as part of their evaluation of DOE's CCA. While the particle size distribution parameter does not explicitly enter into the conceptual model used by DOE in its CCA for the caving process (DOE, 1996a), the EPA (see Attachment II) has requested that the sampled values for waste shear strength in the caving model be derived from the assessed particle size distributions, using an empirically observed correlation between the critical shear resistance of unconsolidated materials under hydraulic transport and the particle sizes being transported. An evaluation of the applicability of this correlation to model caving is outside the scope of this study.

2.3.3 Summary

In summary, a distribution of particle diameters will be present within the waste materials that can be brought to the surface by a spalling or caving release at any time. The distribution is affected by the initial composition of the emplaced waste and subsequent processes, including mechanical response due to creep closure, cementation along contact zones and/or pore spaces by new chemical phases (iron hydroxides, MgO hydration and reaction products, precipitated halite), anoxic corrosion, and possible microbial degradation, as predicted by PA. Probability distributions are needed for the population of particle diameters for WIPP waste disposal room contents that could become part of a release to the surface (e.g., by spalling or caving) as a function of time.

2.4 Waste Particle Diameters

The distribution of waste particle diameters in the vicinity of a borehole inadvertently drilled into the repository sometime in the 10,000 years after WIPP closure is of primary interest.

2.4.1 Variability

As shown in Figure 2-2, within a specific volume (v) of waste at any location (x) and time (t), there will be a number of individual particles, each with an equivalent diameter (d). There will be significant variability in the sizes of those individual particles, which can be expressed as a statistical frequency of values, $f\{d\}_{v,x,t}$. As illustrated in Figure 2-3, this statistical frequency, if known, could be expressed as a cumulative distribution:

$$F\{d\}_{v,x,t} = [d_i, X_i], i = 1, \dots, n$$

where

d_i specifies a particle diameter,

X_i is the percentage of particles which are smaller than the associated diameter d_i , and

n is the number of pairs $[d, X]$.

The distribution is cumulative and satisfies the conditions ($d_i < d_{i+1}$) and ($X_i < X_{i+1}$). The number of pairs $[d_i, X_i]$ specified in each distribution depends on the accuracy desired. This approach is consistent with the distribution construction process described in the CCA, Appendix PAR (DOE, 1996a). Although such percentiles are generally applicable, the natural variability might be adequately described in terms of a specific frequency distribution "form" (e.g., lognormal) and the characteristics of that distribution (e.g., the mean $m\{d\}_{v,x,t}$ and standard deviation $s\{d\}_{v,x,t}$).

2.4.2 Uncertainty

As illustrated in Figure 2-4, at any particular scale, location, and time, there will be uncertainty in what the frequency distribution actually is. This uncertainty (separate from the natural variability) can be expressed in terms of a probability distribution (e.g., a probability distribution of the characteristics of the frequency distribution, such as $p[\{d_{90}\}_{v,x,t}]$ or $p[m\{d\}_{v,x,t}, s\{d\}_{v,x,t}]$). This probability distribution for the population of particle sizes at a scale, location and time coincident with an inadvertent intrusion is the topic of interest. It can be addressed in a variety of ways, as discussed below.

2.4.2.1 Variability among Subpopulations

As illustrated in Figure 2-5, unless the degraded waste is homogeneous at the scale of interest, there will also be variability among the particle size populations at different locations (at the same scale and time). If the form of the distribution is the same for all locations, then this natural variability among locations can be expressed in terms of the statistical frequency of the population characteristics (e.g., mean and standard deviation), $f\{m\{d\}_{v,x,t}, s\{d\}_{v,x,t}\}$. This natural variability might be adequately described in terms of a specific frequency distribution "form" (e.g., normal) and the characteristics of that distribution (e.g., the mean $m\{m\{d\}_{v,x,t}\}$ and standard deviation $s\{m\{d\}_{v,x,t}\}$ of the average particle size at various locations). However, at any particular time and scale, there will be uncertainty in what this frequency distribution actually is. This uncertainty can be expressed in terms of a probability distribution (e.g., a joint probability distribution of the characteristics of average particle size at various locations, $p\{m\{m\{d\}_{v,x,t}\}, s\{m\{d\}_{v,x,t}\}\}$), and similarly, the characteristics of the standard deviation of particle sizes at various locations. Hence, to sample the population distribution of particle sizes for an inadvertent intrusion (at a specific scale and time, but a random location), the mean and standard deviation of the average particle size and its variability are sampled and used with the assumed distribution form.

Alternatively, the different possible population distributions can be identified, and the volume over which each is homogeneous and the relative frequency of such volumes in the repository are assessed. For example, a specific waste stream might have a specific population distribution, might be in isolated drums, and might comprise 20% of the repository contents. At the scale of individual drums (or smaller), this population distribution would occur (e.g., randomly sampled in Monte Carlo simulation) 20% of the time. At a larger scale (e.g., several drums), the population distribution of each of the number of drums comprising that volume could be sampled randomly and then mixed together (in Monte Carlo simulation).

2.4.2.2 Scale-Dependent Variability

The variability of particle sizes throughout the entire repository at a particular time can be expressed as a frequency of values, $f\{d\}_t$. Similar to smaller scales, this natural variability, if known, might be adequately described in terms of a specific frequency distribution "form" (e.g., lognormal) and the characteristics of that distribution (e.g., the mean $m\{d\}_t$ and standard deviation $s\{d\}_t$). However, at any particular time there will be uncertainty in what that frequency distribution actually is. This uncertainty (separate from the natural variability) can be expressed in terms of a probability distribution (e.g., a joint probability distribution of the characteristics of the frequency distribution, $p\{m\{d\}_t, s\{d\}_t\}$). As the scale decreases from the repository scale: (1) the variability in particle sizes at that scale decreases from the variability at repository scale down to a limit of zero at the scale of individual particles; and (2) the variability in the mean value among different locations at that scale increases from zero to a limit of the variability among individual particles at repository scale. For example, as illustrated in Figure 2-6, the variability in the average values of different populations, as expressed by the standard deviation of these average values, would decrease to zero at some "representative" volume. If the particle sizes are independent (even at close distances), the variability will change with the square root of the volume that scale represents. Hence, the steps in simulating the population at a random location at a particular time and scale are as follows:

1. Assess $p\{m\{d\}_t, s\{d\}_t\}$ over the repository scale at time t .
2. From step 1, randomly simulate $m\{d\}_t$ and $s\{d\}_t$ over the repository scale at time t .
3. Assess the relationship of variability to scale (v).
4. From steps 2 and 3, determine:

$$\begin{aligned}m\{m\{d\}_{v,x,t}\} &= m\{d\}_t \\s\{m\{d\}_{v,x,t}\} &= \text{function of } s\{d\}_t \text{ and } v, \\m\{s\{d\}_{v,x,t}\} &= \text{function of } s\{d\}_t \text{ and } v, \text{ and} \\s\{s\{d\}_{v,x,t}\} &= 0.\end{aligned}$$

5. From steps 1 and 4, randomly simulate $m\{d\}_{v,x,t}$ for each inadvertent intrusion event.
6. From steps 1, 4 and 5, produce $f\{d\}_{v,x,t}$ for each inadvertent intrusion event.

2.4.2.3 Spatial Correlation

Particle sizes at different locations, especially close to each other, may be related. As illustrated in Figure 2-7, this spatial correlation can be expressed in terms of the uncertainty in particle size at one location as a function of the known particle size at another location, and the distance from that location. At a specific distance (i.e., the "autocorrelation distance"), the particle sizes become independent. By combining the spatial correlation function with the probability distribution for the size of a random particle in the repository (which considers both natural variability throughout the repository and the uncertainty in that variability), the probability distribution for particle size populations can be determined for various scales (i.e., distances) by simulation.



2.4.3 Summary

A probability distribution is needed for the particle size population at a particular vertical location scale and time coincident with an inadvertent intrusion event at a random areal location in the waste. At the scale of interest, it is expected that spatial heterogeneity of the waste and of degradation processes may result in less variability in particle sizes than at the overall repository scale and significant differences in populations at various locations. Assessments of the following parameters can be used to produce the desired results in one of several ways:

- probability distribution for the size of a random particle at that vertical location in the repository at time t , considering both variability and uncertainty at large scale;
- probability distribution for the mean and standard deviation of the population of particle sizes throughout the repository at time t , separating variability and uncertainty at large scale;
- probability distribution for the mean and variability of the population characteristics among different locations at a specific scale at time t , separating variability and uncertainty at small scale;
- the ratio of the expected variability in the population at both small and large scale (in terms of the standard deviation) to the total uncertainty in the size of a random particle in the repository (also in terms of standard deviation);
- relationship of the variability in the population means among different locations and of the population variability at any location as a function of scale;
- spatial correlation in particle sizes throughout the repository at time t , especially in terms of the representative volume (or autocorrelation distance); or
- set of possible population distributions, and homogeneous volume and relative frequency of each.

Not all of the above assessments are required to produce the desired results. However, they are interrelated, and need to be consistent. It must be remembered that PA calculations are undertaken based on a particular conceptual model, incorporating a number of assumptions. The definition of particle size populations, for the purposes of this elicitation, must be compatible with the context of the PA calculations, especially in terms of scale. However, such PA calculations are outside the scope of this elicitation.

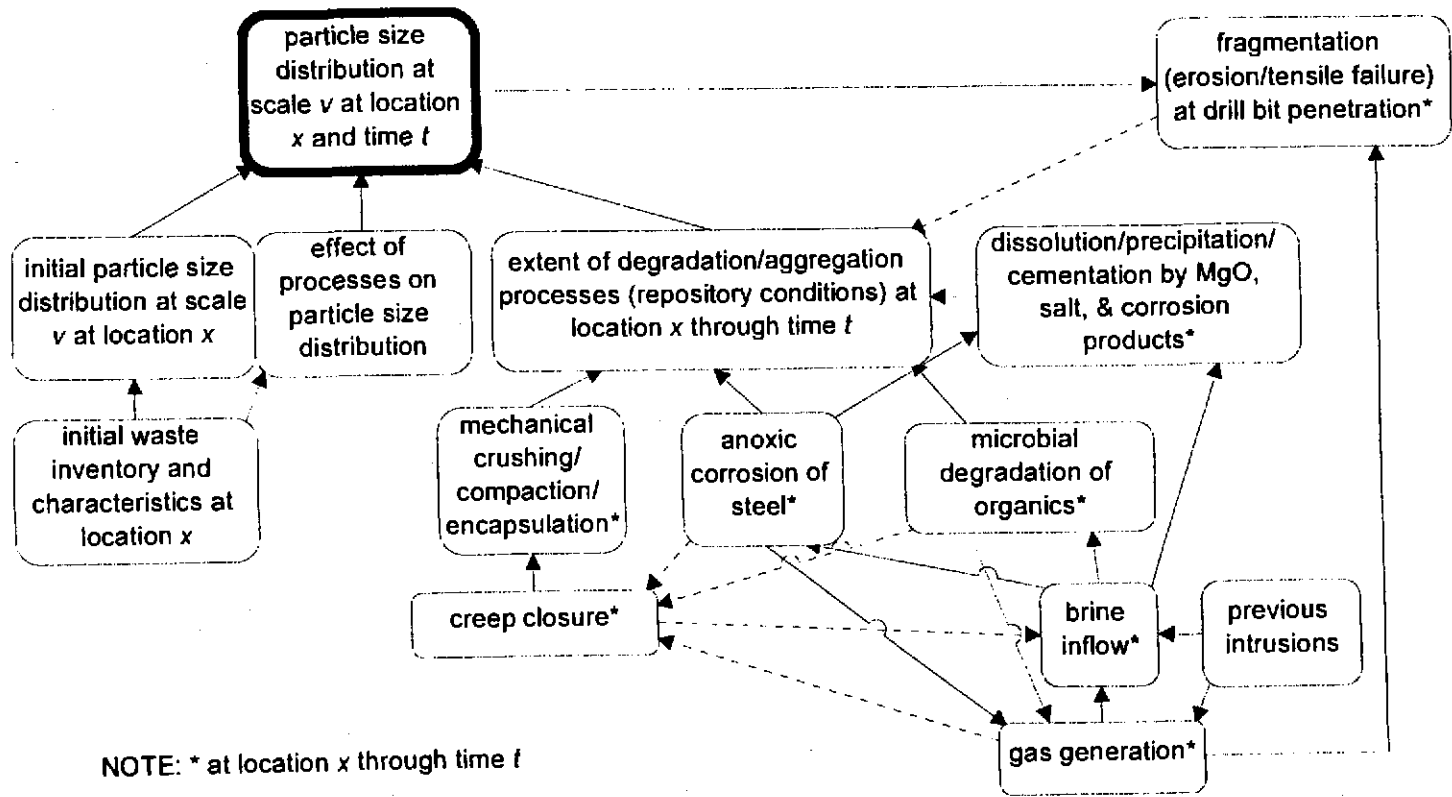

Note: "brine inflow" implies brine volume, and "gas generation" implies gas pressure

Figure 2-1 Influence Diagram for Particle Size Distribution

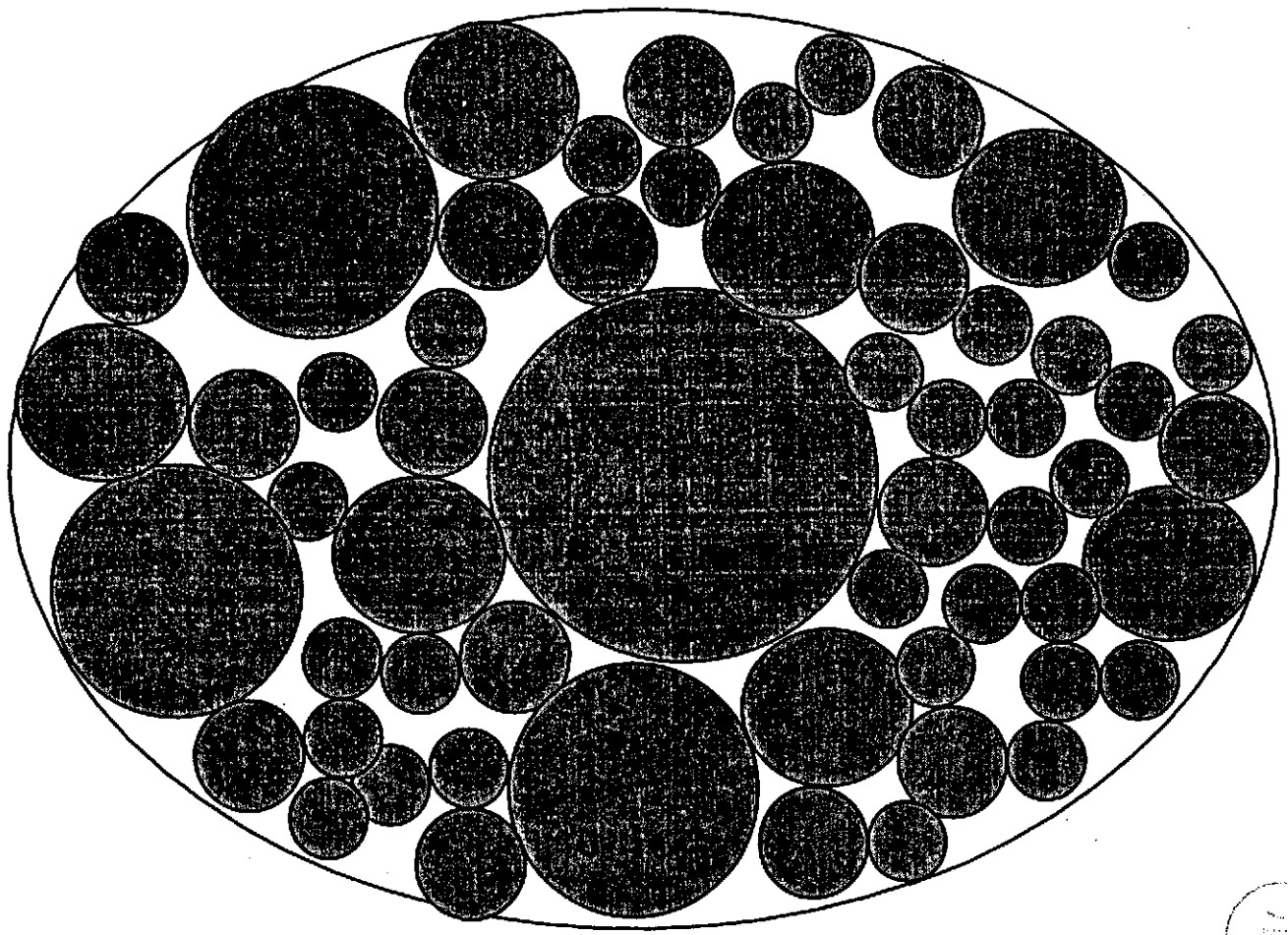

11

Figure 2-2 Population of Waste Particle Diameters

Information Only

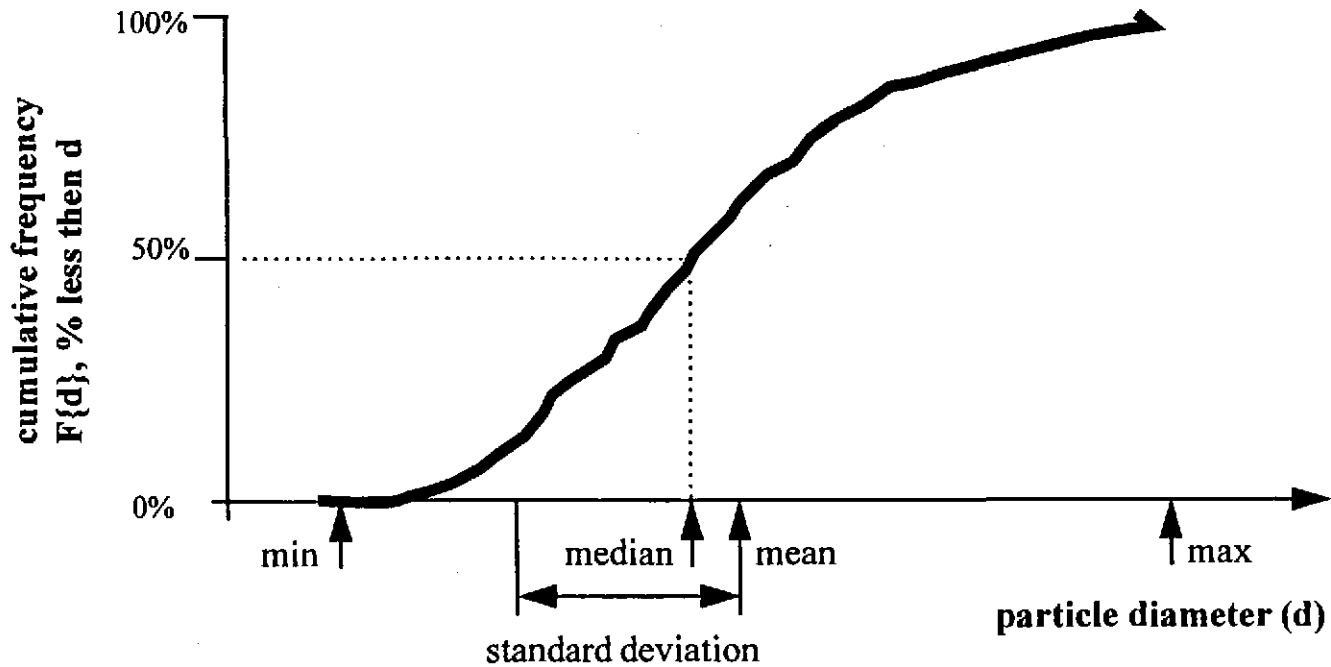

Possible Descriptors:

- minimum value{d}, maximum value{d}
- $F\{d=10^{-3}\}$, $F\{d=10^{-2}\}$, $F\{d=10^{-1}\}$, $F\{d=10^0\}$, $F\{d=10^1\}$, $F\{d=10^2\}$, $F\{d=10^3\}$
- d_{10} , d_{33} , d_{50} , d_{67} , d_{90}
- most common value{d}
- distribution form(e.g., lognormal) and characteristics (e.g., mean and standard deviation)

Figure 2-3 Statistical Description of Population of Waste Particle Diameters

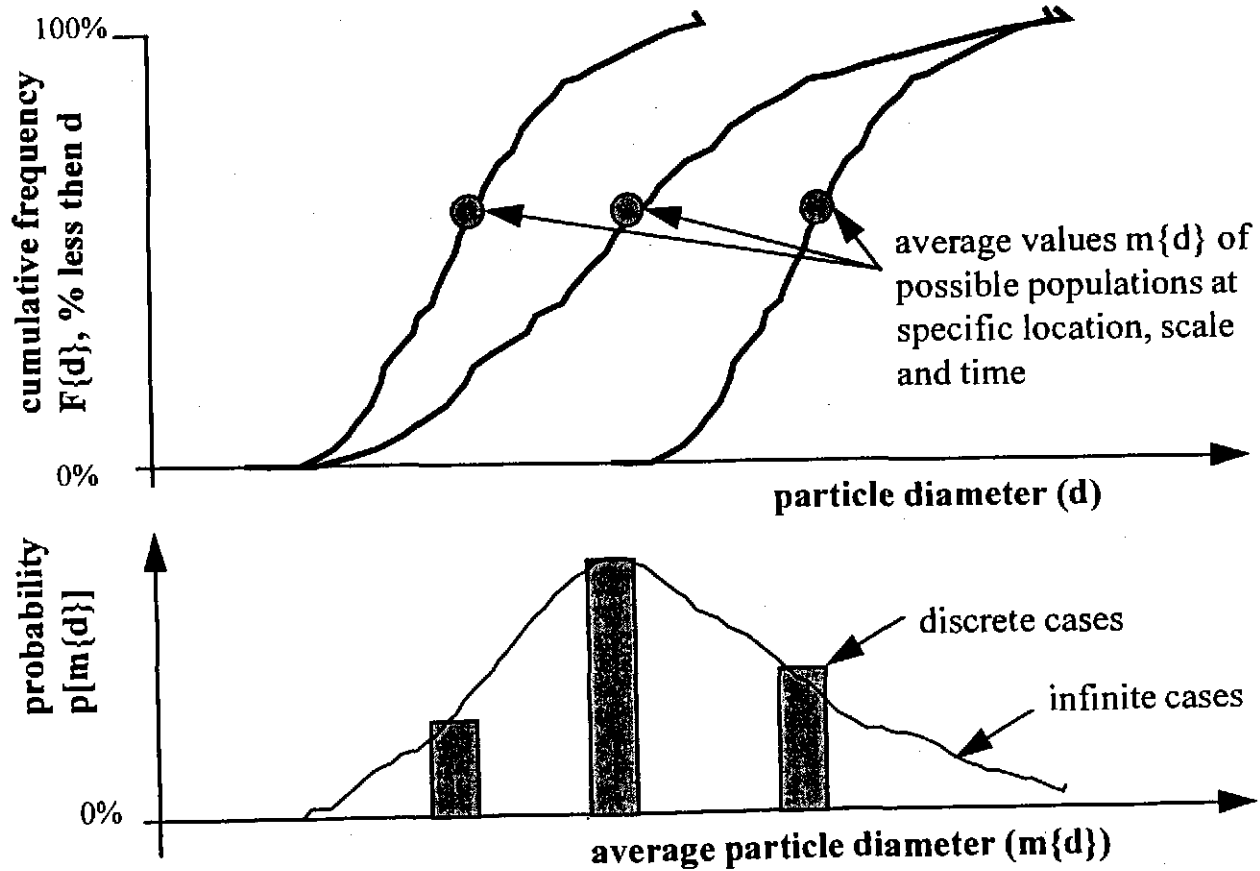

Note: could use other descriptors besides average

Figure 2-4 Uncertainty in Specific Population of Waste Particle Diameters

Information Only

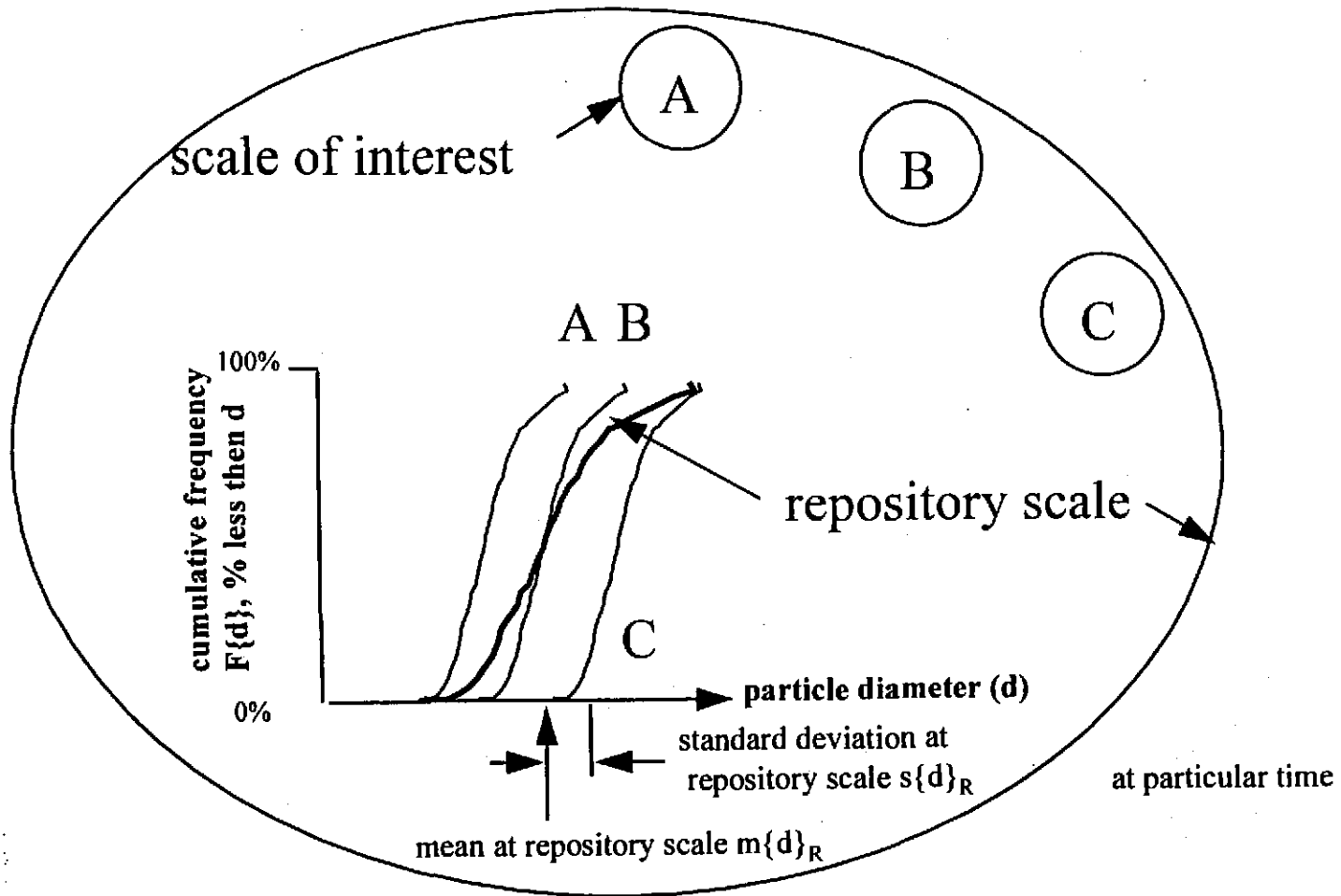
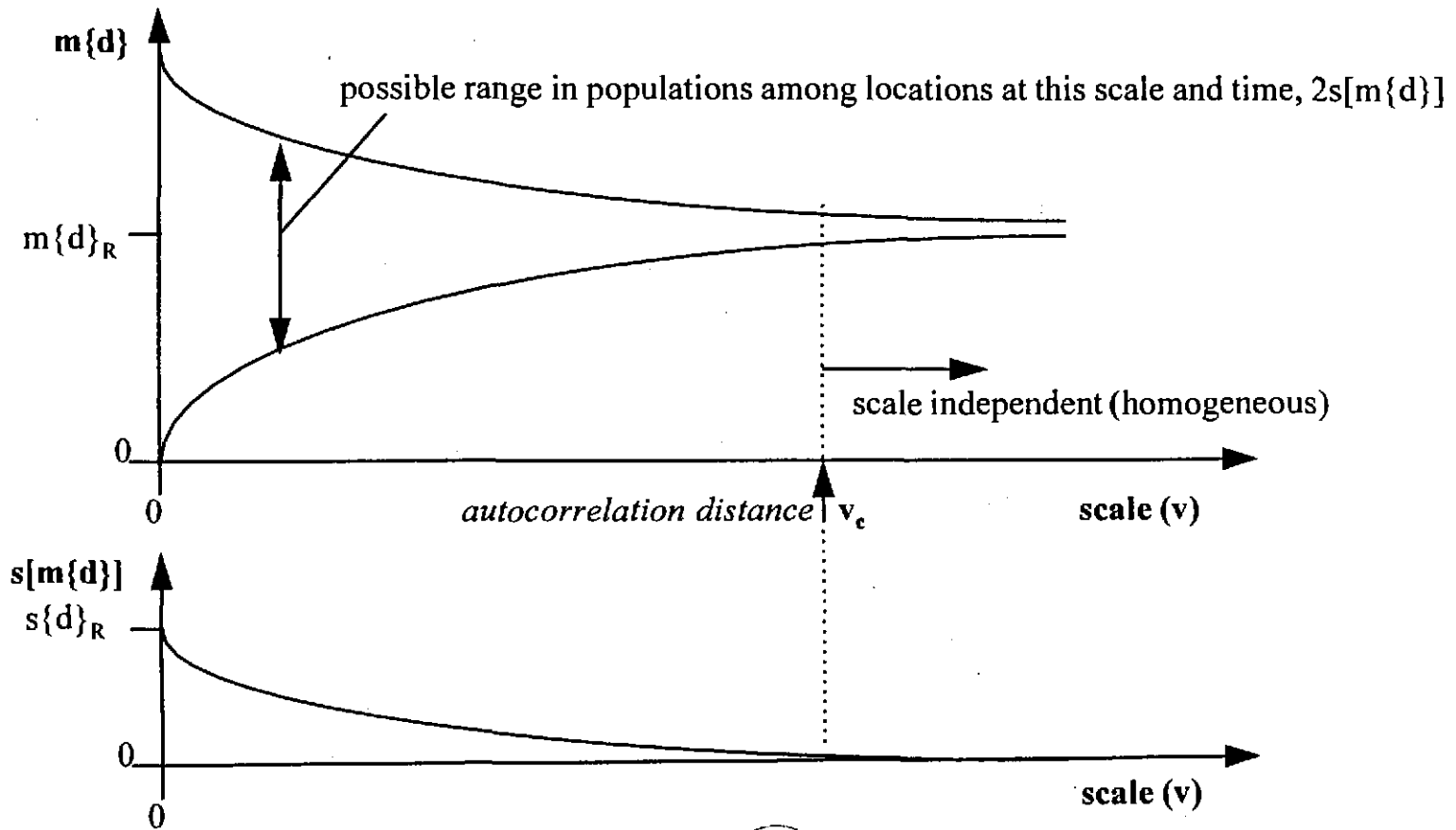

Figure 2-5 Variability of Waste Particle Size Populations

Information Only



M

Figure 2-6 Scale-Dependent Variability of Waste Particle Size Populations

Information Only

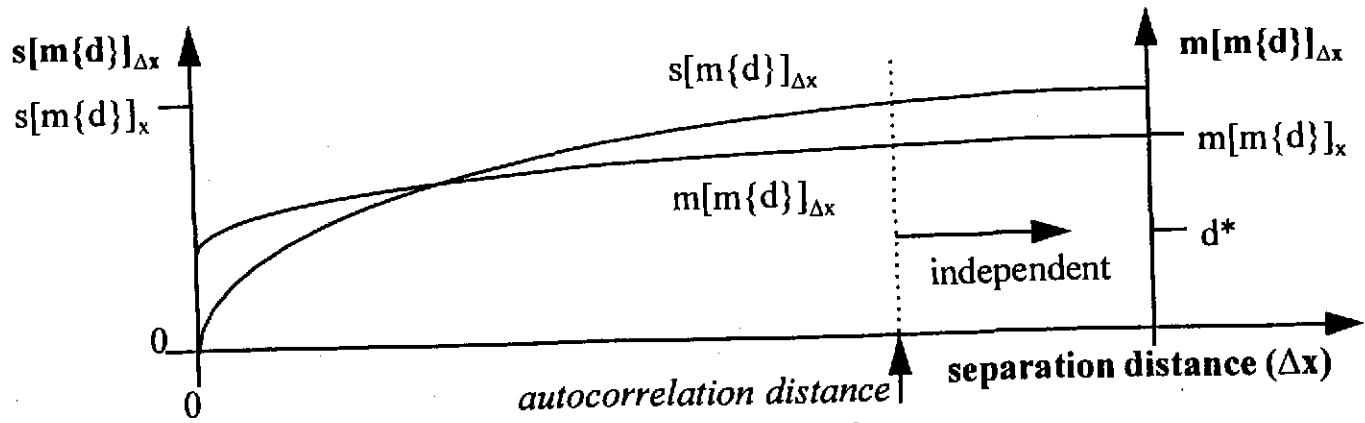
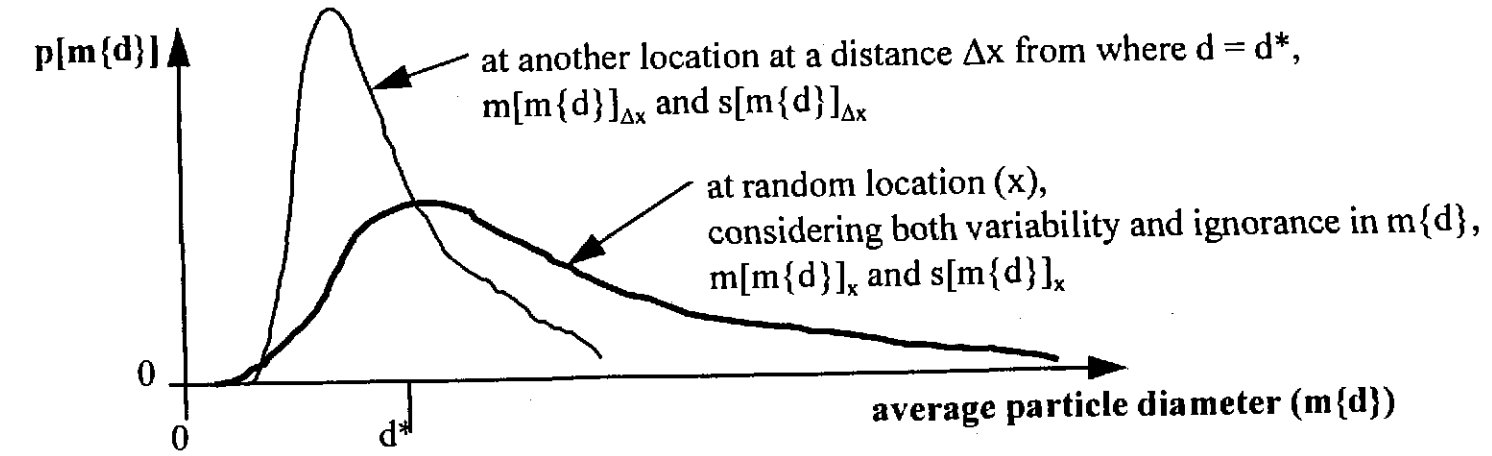

Note: could use other descriptors besides average; at specific time and scale



Figure 2-7 Spatial Correlation in Particle Size Populations

3. Technical Approach

This section presents the *technical* approach taken to estimate the waste particle diameters at the time of inadvertent human intrusion, consistent with the technical background presented in Section 2.

In the absence of definitive direct data, existing and especially future waste particle diameters must be estimated based on expert judgment. In order to ensure such estimates are as accurate as possible (i.e., consistent with all available information), a formal process was used to elicit the judgment of a qualified and unbiased group of experts. Public and observer input was solicited throughout the process and was considered, along with other technical information, by the expert panel. A qualified elicitor was used to guide the process towards a defensible resolution of the technical issue.

The procedures for eliciting subjective assessments from one or more experts are designed to ensure accurate and defensible probability distributions, based on the judgment of those expert(s) consistent with all available information, by mitigating potential problems to the extent possible. The *elicitation* consists of an explicit interaction between:

- *the elicitor*, who understands probability, elicitation, and the specific parameter definitions and model; and
- *the technical experts* who are most familiar with all available information and are best qualified, as well as unbiased, to interpret that information (less *ignorance*).

The variables of the expert elicitation process include:

- the number and credibility of expert(s), such that they are a representative sample of the technical community;
- the form of interaction among experts (if more than one), and the degree of consensus to be achieved among them;
- the degree and form of outside participation and review;
- the thoroughness of information collection and review;
- the specific elicitation techniques used, and the detail and precision to be achieved; and
- the degree of the defensibility of the results and documentation of the process.

The general expert elicitation procedures consist of the following activities:

1. *Conditioning* - The expert(s) are trained in probability and review the available information;
2. *Structuring* - The parameters to be assessed are clearly defined (including any assumptions or decomposition/recomposition per the model);
3. *Elicitation* - Depending on the parameter type, the universe of possible parameter values is identified, and then the probability distribution for parameter values is quantified by the experts through questioning by the elicitor. During this questioning, the elicitor looks for and mitigates any

assessment biases and ensures consistency and logical rationale in the assessments. If more than one expert is involved, the elicitor also looks for and mitigates adverse group dynamics, ensures commonality in problem structure, and identifies and attempts to resolve other differences amongst experts (or aggregates their individual assessments).

4. *Verification/Documentation* - The probability distributions and supporting rationale are restated by the elicitor and confirmed (or modified as appropriate) by the expert(s). The entire process is adequately documented to ensure trackability.

The expert judgment elicitation process was conducted in accordance with the CAO Expert Panel Elicitation Plan (Rev. 2) (DOE, 1997b) and the CTAC Experimental Programs Desktop Instruction 1 (CTAC/EP-DI 1, Rev. 0 (CTAC, 1997), which in turn satisfied the requirements outlined in 40 CFR Part 194.26, the EPA Compliance Application Guidance (CAG) and the CAO-Office of Regulatory Compliance (ORC) Expert Judgment Team Procedure (TP) 10.6, Rev. 0 (DOE, 1997a) and CAO Expert Panel Elicitation Plan (DOE, 1997b). All formal panel meetings associated with the elicitation of expert judgment regarding this parameter were conducted on May 5-9, 1997 in Carlsbad, NM. The expert elicitation process was coordinated by the CAO-ORC (Dick Lark) and administered by CTAC (Leif Eriksson). The elicitation process was conducted by an experienced expert panel elicitor (Dr. William Roberds of Golder Associates). The process was open to the public, as described below and in the CAO-ORC Expert Judgment Team Procedure. A complete record of the public meeting (including a transcript) was kept and retained as a process record. The main steps of the elicitation process are described in the following sections and summarized in Figure 3-1. The materials developed during each step as part of the public record are listed in Table 3-1.

Table 3-1 Expert Elicitation Materials

Activity	Materials
3.1. Definition of technical issue(s)	EPA letters dated March 19 and April 25, 1997 (Attachments I and II) CAO ORC Team Procedure (TP) 10.6 (Rev. 0) (DOE, 1997a)/ Plan (Rev. 2) (DOE, 1997b) and CTAC/EP-DI 1, Rev. 0 (CTAC, 1997)
3.2. Public notification	Letter to Stakeholders; media release
3.3. Selection and contracting of experts	Selection forms signed by Selection Committee; resumes, independence forms and Organizational Conflict of Interest forms (when applicable) and contracts signed by each expert
3.4. General orientation and elicitation training	Transcript; background reading materials; viewgraphs; form signed by each expert
3.5. Presentation and review of issue(s)	Transcript
3.6. Preparation of expert analysis by elicitor	Spreadsheet; viewgraphs
3.7. Discussion of analysis by panel members	Transcript
3.8. Elicitation	Transcript; written summary
3.9. Recomposition	Spreadsheet; viewgraphs
3.10. Review and approved or dissenting opinions provided by the experts	Transcript; statements signed by each expert
3.11. Documentation of the process and results	Report; review comments/resolution; statements signed by each expert

3.1 Definition of Technical Issue(s)

The EPA has specified that the CAO must conduct an expert judgment elicitation to determine the probability distribution for the waste particle diameters in the WIPP repository during the 10,000-year regulatory post-closure period (Attachments 1 and 2). This requirement formed the basis of the technical issue to be elicited.

As discussed in Section 2, an inadvertent drill hole intrusion into the repository may cause release of particulate waste material to the surface. This particulate waste material can be separated from the rest of the waste by three processes: (1) cuttings; (2) cavings; and (3) spallings. Cuttings and cavings, which are the waste materials removed by the action of the drill bit and circulating drilling mud, respectively, may occur with an inadvertent drill hole intrusion into the waste. Spalling, which is the removal of particulate material as high-pressure gas within the repository waste causes a blowout of the drilling mud and tensile failure of the waste, may occur if certain precursor conditions occur (SNL, 1997a). A model variable related to the distribution of particle diameters was used in the CCA model (DOE, 1996a) to calculate the volume of spall releases, and might conceivably be of interest in other models (e.g., to estimate the volume of caving releases).

Various materials will be disposed of in the WIPP, each in a specific amount and with an initial particle size distribution, which may vary among locations as a function of scale. These materials will be subject to a variety of processes over the 10,000 years following closure, which may affect their particle size distributions. These processes, as well as their effects, may also vary among locations as a function of time. Hence, the distribution of particle sizes at a specific time and scale may vary among locations, depending on: the initial waste inventory and their characteristics at that location and scale; the extent of processes which have occurred at that location, scale and time; and the effects of such processes on particle size distribution for the materials at that location. Therefore, the technical issue addressed by the expert elicitation is (Appendix C):

What is the conditional probability distribution for the waste particle size frequency distribution (i.e., in terms of percent of the number of particles exceeding a particular size) at a random areal location, at a specified vertical location in the waste room, time and scale, given the initial waste inventory and the predicted extent of each relevant process at that location, time and scale, both just before an inadvertent intrusion and after tensile failure during a spalling event?

Although the radioactivity associated with waste particles is important in order to determine release and exposure, as noted in Section 1.2, this is outside the scope of this elicitation. However, it is possible that conditional probability distributions for radioactivity as a function of particle size (and possibly time) could subsequently be developed and applied to account for this. For example, if radioactivity is approximately independent of particle size, it could simply be apportioned considering the variability in radioactivity among the materials involved. It should be recognized that significant amounts of material (e.g., backfill and salt fragments) might not have any radioactivity.

A waste *particle* is defined herein as an individual piece or aggregated collection of pieces with significant internal strength (e.g., a uniaxial tensile strength greater than 20 pounds per square inch [psi]). As such, particles are much more likely to separate from each other, rather than to break up into smaller pieces.

As illustrated in Figure 3-2, an *equivalent particle diameter* (d) is defined herein as the diameter of a sphere with a volume (v) equivalent to that of the individual particle, where $v = \pi d^3/6$.

3.2 Public Notification

The public and other interested parties were notified at least 10 working days in advance of the expert elicitation, that they had the opportunity to provide input on and observe and comment on this process. The notifications included: notice in the CAO Monthly Calendar; a media release to news organizations in New Mexico and West Texas; a letter to stakeholders in New Mexico, Idaho, and Colorado; and a notice on the WIPP Home Page (<http://www.wipp.carlsbad.nm.us>). In addition, an agenda and a two-page fact sheet on the waste particle diameter issue and the Expert Elicitation process were available through the WIPP Information Center's toll-free telephone number, 1-800-336-9477. The public and other interested parties were asked to contact the WIPP Information Center to receive information and to sign-up to speak at the expert elicitation meeting in Carlsbad on May 5-9, 1997. Interested parties were asked to send written comments to the CAO's Office of Public Affairs.

3.3 Selection and Contracting of Experts

The requirements for the selection of subject matter experts are described in TP 10.6, Rev. 0 (DOE, 1997a). The specific process for identification, selection, and contracting to obtain the services of these experts was as follows:

- The basic technical disciplines appropriate for resolving the identified technical issue are defined in CAO Expert Panel Elicitation Plan, Rev. 2 (CAO, 1997b). They are:
 - *Archeology*, i.e., the characteristics of ancient waste;
 - *Chemistry*, i.e.,
 - corrosion and degradation of plastics, metals, and cellulose, and
 - MgO reactions, including long-term physical characteristics;
 - *Rock, Soil and/or Fluid Mechanics*, i.e., particle movement and geotechnical processes (cementation); and
 - *Performance Assessment Methodologies*, i.e., probability distribution construction.
- The criteria for selection of expert panel members include:
 - Independence from the issue, as required by TP 10.6, Rev. 0, and by 40 CFR 194.26;
 - Perceived expertise as demonstrated by tangible scientific contributions;
 - Professional reputation;
 - Understanding of the general problem area;
 - Balance among all participants so that various subject matter experts were represented; and
 - Availability and willingness to participate.

- Professional organizations, advisory groups, and university officials were requested to provide names and resumes of individuals who are experts in one of the above areas, who meet the criteria, and who could serve on the expert panel.
- The Expert Panel Manager, Leif Eriksson, who was appointed by the Assistant Manager of the CAO ORC, appointed two individuals (Prof. Charles Fairhurst - University of Minnesota and Bob Neil - EEG) who met the requirements as defined in TP 10.6, Rev. 0, to serve with him as the "selection committee." Resumes are provided in Appendix D. They reviewed a list of potential expert panel candidates to determine who were qualified to meet the expert panel requirements defined in TP 10.6, Rev. 0, and the Expert Panel Elicitation Plan, Rev. 1, respectively. Based on the selection committees' evaluations of the scope of work, it was agreed that a generalist be added to the five disciplines/areas listed in the Expert Panel Elicitation Plan, Rev. 2. Available resumes were then reviewed and the individuals who best met the requirements of qualification, availability, and DOE's Organizational Conflict of Interest were selected and offered a contract.
- The experts comprising the panel, and their affiliation and area of expertise, are identified in Table 3-2 and resumes are provided in Appendix D. Two members, Drs. Drez and Gross, are considered DOE contractors.
- The elicitor, Dr. William Roberds of Golder Associates Inc., Seattle, Washington, was appointed by the Expert Panel Manager. Resume is provided in Appendix D. Dr. Roberds is an acknowledged probability expert with demonstrated experience in eliciting judgments from individuals. Based on his demonstrated knowledge, skills and abilities, he is considered both a "normative expert" and a "generalist."

Subsequently, the elicitor: 1) trained the subject matter experts in subjective probability assessments; 2) guided the subject matter experts in developing an appropriate conceptual model for resolving the issue and in assessing the relevant model input parameters, consistent with the available information; and 3) synthesized and summarized the subject matter experts' rationale and judgments (including recomposition and documentation). The elicitor also controlled the meeting, including facilitating public input.

Table 3-2 Expert Panel

Name	Affiliation	Subject Matter Expertise
Robert Mutaw, Ph.D.	Woodward Clyde	Archaeology
Paul Drez, Ph.D.	Drez Environmental Associates	Chemistry
David Grandstaff, Ph.D.	Temple University	Chemistry
Patrick Domenico, Ph.D.	Texas A&M University	Generalist
Michael Gross, Ph.D.	Science Applications International Corp.	Performance Assessment
Paul LaPointe, Ph.D.	Golder Associates	Rock, Soil and/or Fluid Mechanics

3.4 General Orientation and Elicitation Training of Experts

Training and orientation requirements are provided in TP 10.6, Rev. 0, and in the Expert Panel Elicitation Plan, Rev. 2. Training consisted of mandatory reading materials, optional reading materials, group

orientation, and group training on the elicitation process. The public and other interested parties were welcome to observe both orientation and training.

Reading materials consisted of a series of reference documents utilized in the development of the CCA and were provided on CD ROM disk to the expert panel members prior to the start of the elicitation. Additional materials included a copy of TP 10.6, Rev. 0, (DOE, 1997a) the Expert Panel Elicitation Plan, Rev. 2 (DOE, 1997b) the Spallings Release Position Paper (draft for technical review, SNL, 1997a), the Chemical Conditions model (SNL 1997b), relevant parts of the peer review reports, and a paper on subjective assessments (Roberds, 1990). These reading materials also were made available to the public and other observers during the elicitation process. Key reading materials are listed in Table 3-3.

Group orientation consisted of administrative and technical orientation. Through the orientation process, panel members, as well as observers, were made familiar with the WIPP containment system, the relationship of the parameter to be considered with the containment system, and the performance of the containment system as depicted in the CCA. All materials presented during the orientation are provided in Appendix A. Every time a new observer attended, an abbreviated presentation of the orientation was provided.

Elicitation training consisted of training the expert panel members in the expert judgment elicitation process, with particular emphasis on forming probability judgments. This was intended to reduce any potential biases in the assessments and to better quantify uncertainties. The training materials consisted specifically of discussions on the following topics, as discussed in Roberds (1990): 1) variability and statistics; 2) uncertainty and probability distributions; 3) decomposition; 4) parameter assessment techniques, with practice assessment #1, potential biases, and practice assessment #2; and 5) elicitation process and techniques, including roles, public input, decomposition, convergent pair-wise comparison techniques, verification, and documentation. These training materials are presented in Appendix A.

3.5 Presentation and Review of Issue(s)

The formal elicitation process commenced with the elicitor providing a detailed presentation of the technical issue. SNL then provided technical and scientific information on the issue being elicited. The public and observers were invited to provide their technical and scientific views directly to the Panel during this process. Guidelines for the public's participation are provided in TP 10.6, Rev. 0 (Section 5.3 and Attachment V). The only interested party requesting to make a presentation was the EEG; presentation was provided on May 6, 1997. The material presented at the meeting was made available to all participants, including the observers, and is available in the project files.

3.6 Preparation of Expert Analysis by Elicitor

The elicitor began the elicitation by reducing the issue into more manageable parts, which would be easier to assess and then could be recombined. This preliminary "decomposition model" considered future processes that affect particle size and how such effects might be described and evaluated. This preliminary model was developed to an appropriate level of detail for assessment by the expert panel.



Table 3-3 Key Background Reading Material

1. CTAC Experimental Programs Desktop Instruction "Expert Panel Elicitation" (CTAC/EP-DI 1) Revision 0, dated May 2, 1997.*
2. EPA letter from E. R. Trovato to the Honorable Alvin Alm, dated 3/19/97
3. WIPP Stakeholder letter from George Dials dated 4/21/97, WIPP Expert Elicitation Panel Fact Sheet (including agenda)
4. EPA letter with two enclosures from E. R. Trovato to G. Dials dated 4/25/97
5. 40 CFR 194.26 preamble discussion
6. Background document text to 40 CFR 194 pertaining to "6. Use of Expert Judgment"
7. Pages 38-40 of Compliance Application Guidance for 40 CFR 194*
8. CAO Team Procedure (TP) No. 10.6, Revision 0 on "Expert Elicitation," dated 4/14/97*
9. CAO QAPD, CAO-94-1012, Revision 0, Section 1.5 (Records)*
10. CAO Team Plan, "Expert Panel Elicitation Plan," (Revision 2Q-2) (DOE/CAO-97-2223)*
11. Compliance Certification Application 40 CFR Subpart B and C on CD ROM (without references) with ERRATA (appropriate sections to be read at the discretion of the Panel member)
12. "Transuranic Waste Baseline Inventory Report" (Revision 2), dated 12/95
13. Final Report, "Supplementary Conceptual Models Peer Review Report," dated 12/96
14. Final Report, "Conceptual Models Second Supplementary Peer Review Report," dated 1/97
15. Final Report, "WIPP Conceptual Models Third Supplementary Peer Review Report," dated 4/97
16. Final Report, "Waste Characterization Analysis Supplemental Peer Review Report," dated 12/96
17. Final Report, "WIPP Engineered Systems Data Qualification Supplementary Peer Review Report," dated 12/96
18. "Spallings Release Position Paper: Description and Evaluation of a Mechanistically Based Conceptual Model for Spall," by SNL, dated 4/17/97
19. "WIPP with Magnesium Oxide Back-fill," J. Bredehoft and P. Hall, Version 1.2, dated 10/96
20. "Chemical Conditions Model: Results of the MgO Backfill Efficacy Investigation," by SNL, dated 4/23/97
21. TRU Waste Sampling Program: Volume I—Waste Characterization, T. Clements, Jr. and D. Kudera (EGG-WM-6503) dated 9/85
22. SAND96-2538, "Hydrogen Generation by Metal Corrosion in Simulated Waste Isolation Pilot Plant Environments," dated 3/97
23. SAND96-2582, "Microbial Gas Generation Under Expected Waste Isolation Pilot Plant Repository Conditions," dated 3/97
24. "Methods for Developing Defensible Subjective Probability," Wm. J. Roberds, Ph.D., 1990
25. "Effects of Bulk Density on Sediment Erosion Rates," R. Jepsen, J. Roberts, and W. Lick

Table 3-3 Key Background Reading Material (continued)

-
- | | |
|-----|---|
| 26. | “Measurements of Erosion of Undisturbed Bottom Sediments with Depth,” J. McHeil, C. Taylor, and W. Lick |
| 27. | “International Peer Review of the 1996 Performance Assessment of the U.S. Waste Isolation Pilot Plant (WIPP),” report of the NEA/IAEA International Review Group, April 1997 |
| 28. | “Preservation of Metallic, Ceramic and Organic Materials Encapsulated in Salt: Evidence and Prehistoric Salt Mining Activities in the Hallstatt and Hallein areas of the Salzkammergut, Austria,” draft report submitted by Itasca Consulting Group, Minneapolis, Minnesota, April 1997 |
| 29. | “Machina Ex Deo.” L. White, Jr., MIT Press, 1968 |
| 30. | “Chance & Necessity,” J. Monod, October 1971, Alfred A. Knopf, Publisher, New York |
-

*Mandatory

M

3.7 Discussion of Analysis by Panel Members

After presentation of the preliminary model, that model and the relevant available information were discussed by the experts. A working model was then developed from the preliminary model based on the expert's input, consistent with available information. This model is discussed in Section 4 and presented in detail in Appendix B. Each of the model input parameters were identified, defined, and discussed (especially in terms of available information) prior to elicitation (see Section 3.8). The observers were afforded the opportunity to comment on the process and provide input. All observers input (whether questions or statements) as well as the panels responses to such input, was documented and is available in the project file. The elicitor ensured that the discussions were comprehensive and thorough, and that the decomposition was logical, meaningful, and practical. The elicitor then summarized the discussions for panel concurrence.

3.8 Elicitation

The EPA's Background Information Document (BID) for 40 CFR Part 194, Section 6.1.2, (EPA, 1996) cites several U.S. Nuclear Regulatory Commission (NRC) publications (NUREGs) as examples of expert elicitation processes that have been conducted. These publications, as well as Roberds (1990), also define various elicitation methods (e.g., individual interviews/aggregation, interactive group/consensus, or Delphi). Because of the focused parameter issue, the “Interactive Groups” method was employed in the elicitation process, using an elicitor. In this process, the experts were in a face-to-face situation with both one another and with the elicitor when they gave their opinion. The elicitor, however, had the flexibility to select the details of the expert judgment elicitation process. The elicitor was responsible for ensuring that the process and results were defensible (i.e., logical and consistent with all available information). Hence, as part of the elicitation process, the elicitor did the following (in addition to training - Section 3.4 and development of the decomposition model - Sections 3.6 and 3.7):

- controlled the meeting and led discussions (e.g., asking questions);
- identified and mitigated biases and/or group dynamics;
- identified and reconciled differences among experts to the extent possible; and
- synthesized and summarized discussions and results (e.g., quantification of uncertainty).

The specific steps the elicitor and panel went through in assessing each model input parameter were:

1. Define the parameter unambiguously (e.g., average particle size [in terms of volume] at a random location at a specific scale and time [see Section 3.7]).
2. Define the appropriate scale for the parameter (e.g., cubic meters).
3. Identify the relevant information pertaining to this parameter.
4. Determine and justify (based on the available information) the upper and lower bounds for the parameter value.
5. Identify any important conditions/assumptions which would affect the value of the parameter (e.g., by asking how values outside the bounds could occur, if at all), and all possible values.
6. Assess the cumulative probability associated with several values across the range (from 10% to 90% cumulative probability), either by direct assessment (as done in the almanac tests during the training, see Appendix A) or through convergent pair-wise comparisons (e.g., similar to an eye exam, where one chooses between two options, one of which is of known likelihood in this case, which are modified until indifference is achieved). People are generally more comfortable with comparative lotteries (i.e., "this is more likely than that") than with direct assessments, at least initially, although direct assessments can be used if the experts prefer. An example is illustrated in Figure 3-3.
7. Assess several specific percentile values, either by direct assessment or through convergent pair-wise comparisons (e.g., using 2 and 3 "intervals"). For example, to define the 50 percentile value, the elicitor would select a threshold value for the parameter of interest x (e.g., 4), and would ask the experts to choose between event $A = \{X < 4\}$ and event $B = \{X > 4\}$ as being the most likely. The elicitor would then adjust the threshold value until the expert is indifferent to the choice, and that threshold value would equal the 50 percentile value. Similarly, to define the 33 and 67 percentile values, the elicitor would select two threshold values for the parameter of interest x (e.g., 3 and 6), and would ask the experts to choose between event $A = \{X < 3\}$, event $B = \{3 < X < 6\}$, and event $C = \{X > 6\}$ as being the most likely. The elicitor would then adjust the threshold values until the expert is indifferent to the choice, and those threshold values would equal the 33 and 67 percentile values, respectively.
8. Directly assess and justify (based on the available information) the most likely value and the shape of the distribution (e.g., in terms of symmetry and modality).
9. Synthesize the information developed above into a probability distribution (see Section 3.9).
10. Verify that the probability distribution (e.g., specific percentile values) represents the experts' judgments (see Section 3.10).

Depending on the degree of unanimity achieved during open discussions, the elicitor could choose to elicit each individual panel member's judgment as a precursor to developing a composite assessment for the group. The differences among the various expert's opinions, especially the root cause, would be identified and reconciled to the extent possible. If group consensus could not be achieved directly, then the individual assessments could simply be aggregated. This aggregate judgment would then be reviewed by each panel member to ensure that it properly reflected his/her judgment. If applicable, dissenting judgments would be documented. However, there was general consensus among the panel.

The result of the elicitation process was the definition and justification of values for each of the model input parameters, as documented in a set of viewgraphs (Appendix C). At the end of the process, the public and observers were afforded the opportunity to comment on the elicitation, and the panel considered their comments prior to finalizing their assessments. This process and the results are presented in Section 5.

3.9 Recomposition

Once each parameter had been assessed, as discussed in Section 3.8, the elicitor composed a probability distribution for each parameter consistent with the panel's input, using, for example, RiskView® or BestFit® software (Palisade), as illustrated in Figure 3-4 and in the Training Materials (Appendix A). These probability distributions were then combined using the decomposition model discussed in Sections 3.6 and 3.7 in order to develop a probability distribution for waste particle diameters for specified conditions (e.g., as a function of the predicted extent of processes at the time and scale of inadvertent intrusion). The type of results of recomposition are presented in Section 6.

M

3.10 Review and Approval or Dissenting Opinions Provided by the Experts

The initial assessments for the model parameters were presented to the experts for their consideration and discussion. The public and other interested parties were also provided the opportunity to observe and comment on the results, and the experts considered their views. The purpose of this review was to ensure that potential misunderstandings were identified and resolved, and that the results properly reflect the experts' judgments. If necessary, the probability distributions for some model parameters were redone based on additional expert panel input, per the procedures presented in Section 3.8, and then recombined, as discussed in Section 3.9. This confirmation of the experts' judgments is presented in Section 5, and the experts' signed statements are contained in Appendix C.

3.11 Documentation of the Process and Results

This final report, which was prepared primarily by the elicitor, documents the expert judgment elicitation process and results, in terms of a model for the population of particle diameters at the time of inadvertent human intrusion, as a function of repository conditions. The expert panel members' signed agreements, along with the results of the elicitation, are provided in Appendix C.

The public and other interested parties had the opportunity to review a May 12, 1997 draft of this report. The only written comments received by May 27, 1997, were submitted by the EEG. EEG's comments were sent to each member of the expert panel, who reviewed them to determine whether the comments would affect their judgment on waste particle diameters, as documented in the draft report. The experts' opinions were polled on May 29. Although generally very constructive and helpful to the enhancement of the quality of this report, the experts did not feel the EEG comments affected their judgments (i.e., did not present new information or reasonable alternative interpretations) presented in the draft report. Statements concurring with this final report have been signed by each of the experts at the end of the basic text of this report.

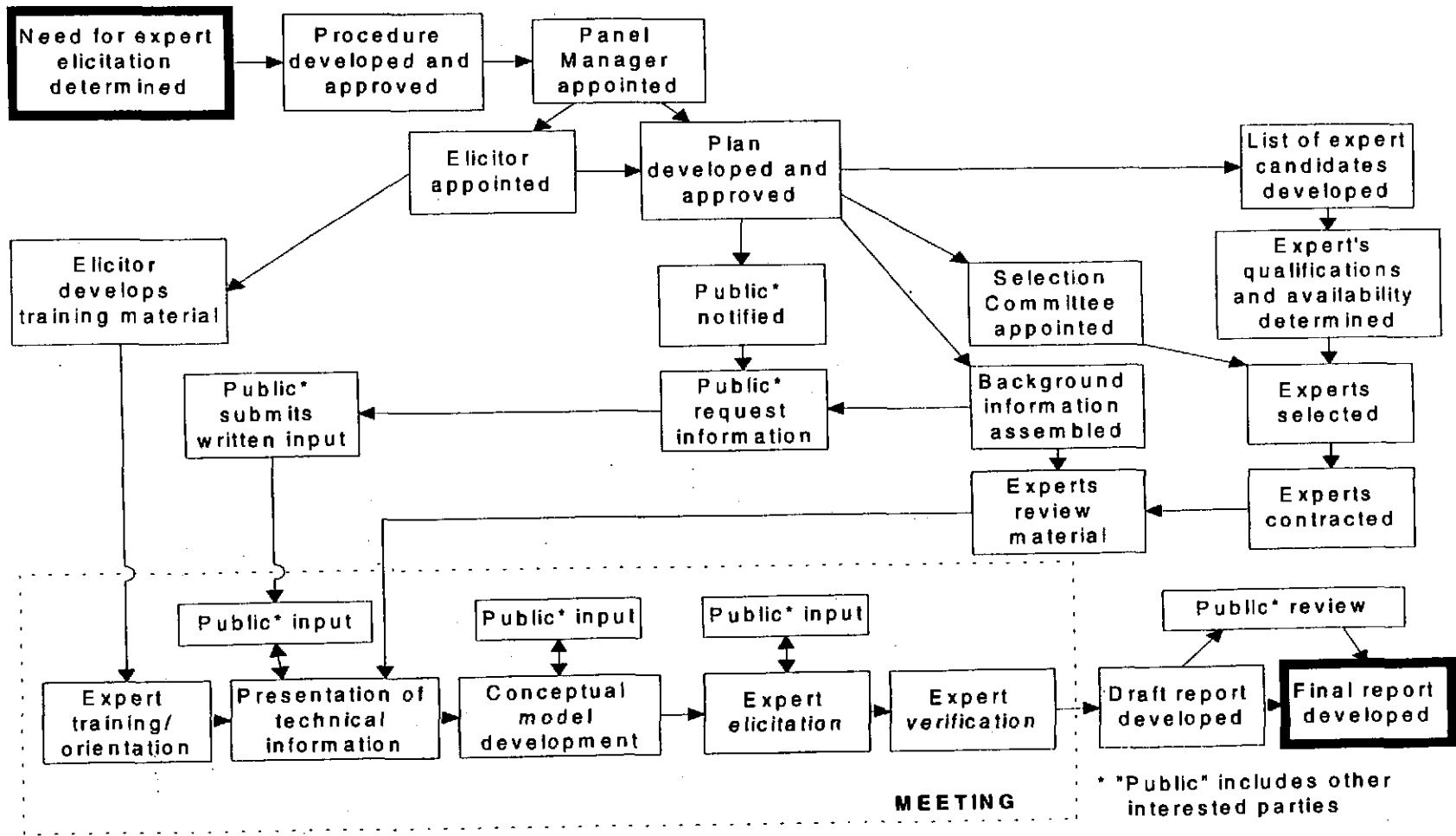
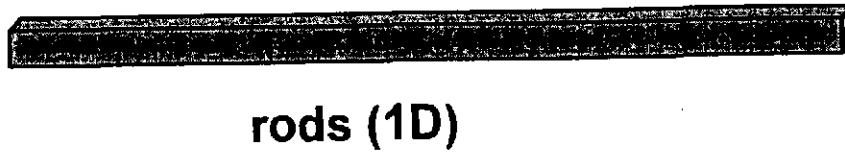
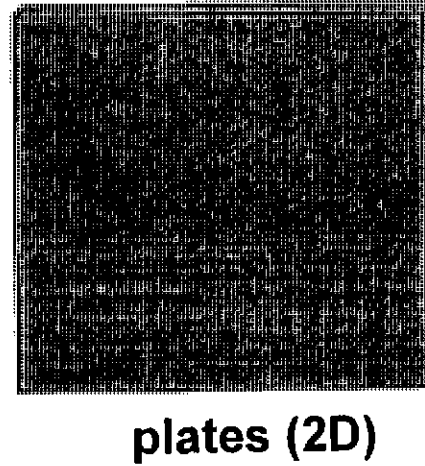
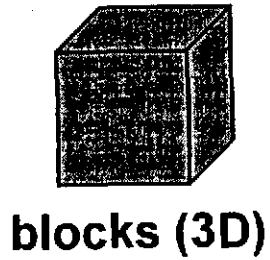

Figure 3-1 Expert Elicitation Process

Information Only



Equivalent particle diameter (d) = diameter of sphere with volume (v) equivalent to individual "particle" $v = \pi d^3/6$

Figure 3-2 Waste Particle Size

Information Only

Choose A or B as most likely

**A = {spin wheel and
land in target area}**

B = {X < 4}

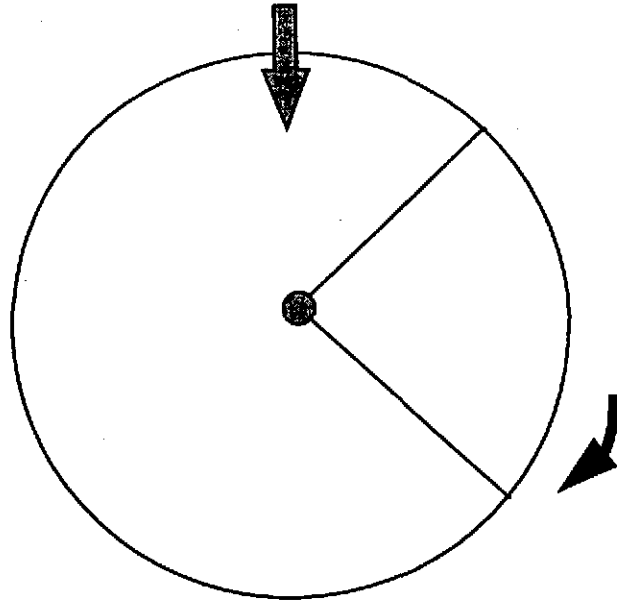

**Adjust size of
target area
(or value of X)
until indifferent
to choice**



Figure 3-3 Probability Wheel

Information Only

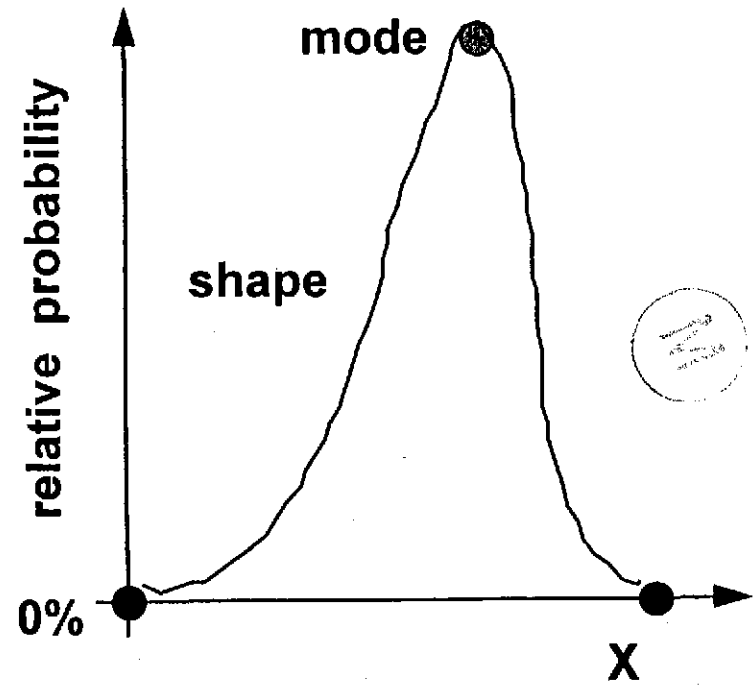
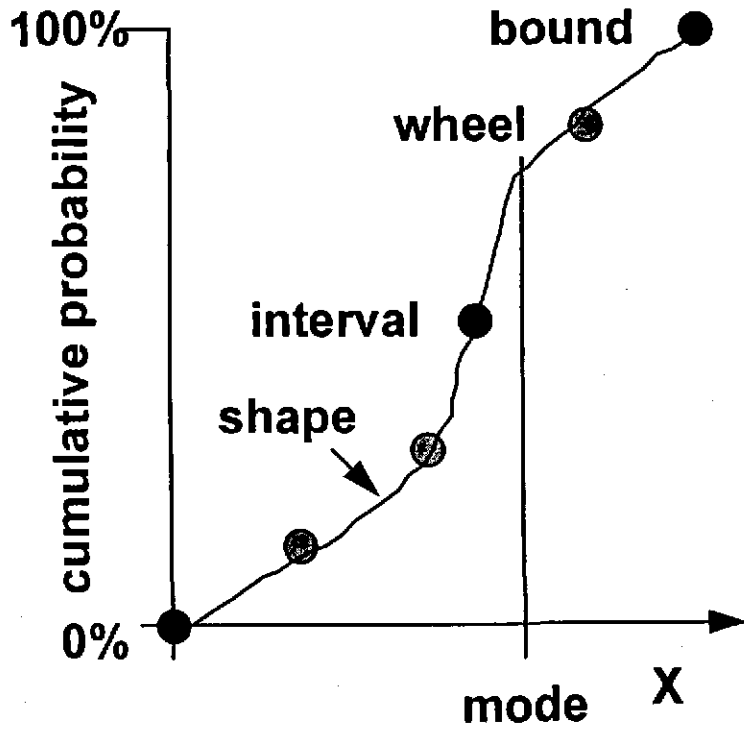

Figure 3-4 Integrated Construction of Probability Distribution

4. Decomposition Model

This section presents the model for decomposing the assessment of waste particle diameters at the time of inadvertent human intrusion. As described in Section 3, this process consists of first abstracting the materials and processes discussed in Section 2, and then describing them in terms of more detailed parameters and algorithms which, when combined, produce a reasonable estimate of waste particle diameters at the time of inadvertent human intrusion. The concepts of the model are described in viewgraphs included as Appendix C. Appendix C also contains the concurrence signatures of the expert panel members.

4.1 Materials and Processes

4.1.1 Types of Processes

As discussed in Section 2, various types of processes can affect particle size distributions; however, each process will tend to have one of three types of effects:

- *Pervasive reduction* - All particles will tend to get smaller due, for example, to corrosion, biodegradation, or dissolution. Consider the simple example of an initial set of six particles of different sizes (5 through 10), as illustrated in Figure 4-1. As illustrated in Figure 4-2, the larger particles will be reduced by more than the smaller particles (2 versus 1), with the resulting byproducts all of size 1.
- *Selective reduction* - Some (but not all) particles will tend to get smaller due, for example, to crushing or fragmentation. In an example based on the same initial set of six particles (Figure 4-1), as illustrated in Figure 4-3, two of the larger particles will be subdivided into two particles each.
- *Aggregation* - Some particles will tend to get larger due, for example, to consolidation/encapsulation or precipitation/cementation. In an example based on the pervasively reduced set of six particles (Figure 4-2), as illustrated in Figure 4-4, two of the larger particles will be combined with several of the smaller particles to form one large particle.

The various processes discussed in Section 2 can be described in the following terms:

- *Corrosion* of iron-base and aluminum-base materials by brine results in pervasive reduction of $F\{d\}$, with some particulate byproducts.
- *Biodegradation* of organic materials, which is affected by the presence of brine, results in pervasive reduction of the particle diameters ($F\{d\}$), without significant particulate byproducts. Although biodegradation of organic materials will result in biomass and inorganics, as well as gas, the panel judges that the biomass would be greatly limited and would comprise a relatively small portion of the waste at any time. Bacterial cells (0.1 to 20 microns in size) are in the most common size fractions present in the repository and, therefore, variations in biomass would not greatly affect the overall particle size distributions. Trace metals and radionuclides present will tend to be in solution, or will quickly adsorb on or co-precipitate with the remaining materials, especially the corrosion products, so that they would not comprise a significant amount of free particles.
- *Dissolution* of soluble materials by brine results in pervasive reduction of $F\{d\}$, with some particulate byproducts.

- *Crushing* of friable materials due to room closure results in a selective reduction of F{d}, although this will be considered as part of the initial conditions.
- *Compaction* of all materials due to room closure results in an insignificant effect on F{d}, except that salt may continue to flow and encapsulate all materials in its path, aggregating such particles.
- *Precipitation* of dissolved MgO, salt, or corrosion products results in pervasive aggregation/cementation of all materials (in addition to particulates).
- *Fragmentation* due to tensile failure (e.g., due to spallings) results in an insignificant effect on F{d} (i.e., because by definition particles are not weak), except for possibly cellulose.

The chemical processes involved in biodegradation, corrosion, dissolution, and precipitation can be summarized as follows:

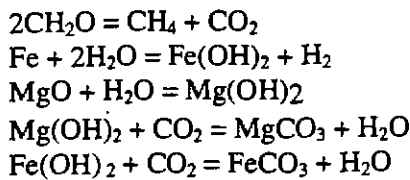

As can be seen, corrosion of Fe competes with dissolution of MgO for available water (H₂O), and dissolution of MgO is probably faster than corrosion of Fe. In either case, salt dissolved in brine precipitates out as H₂O is consumed. Whereas both corrosion and dissolution produce byproducts, biodegradation produces primarily CO₂ and methane.

4.1.2 Material Groups

The processes believed to affect each of the materials identified in Section 2.1 are summarized in Table 4-1, with the double-check marks indicating a higher anticipated biodegradation rate.

Table 4-1 Effects of Processes on Materials

Material	Corrosion	Bio-Degradation	Dissolution	Type
iron-base metal/alloys	✓			1
aluminum-base metal/alloys	✓			1
other metal/alloys				2
other inorganic materials				2
vitrified				2
cellulosics		✓✓		4
rubber		✓		5
plastics		✓		5
solidified inorganic materials				2
solidified organic materials		✓✓		4
cement (solidified)				2
soils				2
steel packaging	✓			1
plastics packaging		✓		5
lead packaging				2
steel plug	✓			1
MgO backfill			✓	6
salt				3

Although not indicated above, encapsulation by salt flow creep and cementation by precipitates can affect any of the materials (i.e., is not material-specific). Also, fragmentation could conceivably affect the particle sizes of cellulose, which are inherently weak.

As shown above, several materials are affected by the same processes. For simplicity, materials that behave in a similar fashion to the various processes have been combined into six material "groups." The group to which each material belongs is indicated in the right-hand column of Table 4-1. These groups are summarized below.

1. *Iron (Fe)- and aluminum (Al)-base metal/alloys* are subject to corrosion.
2. *Other metals/inorganic/vitrified/soils/cements/solidified inorganics* are subject to crushing of friable materials due to room closure, although this is included in the initial particle sizes.
3. *Salt* is subject to crushing/plastic flow/compaction of roof fall particles, although this is included in the initial particle sizes.
4. *Cellulose/solidified organics* are subject to crushing of friable materials (solidified organics) due to room closure, although this is included in the initial particle sizes, and to biodegradation and possibly to fragmentation during spalling.
5. *Rubber/plastics* are subject to biodegradation.
6. *MgO backfill* is subject to dissolution.

As previously noted, all the material groups are subject to cementation and salt encapsulation (especially at the room boundary).

4.1.3 Modeled Processes

Based on the summaries provided in Sections 4.1.1 and 4.1.2, the processes that are explicitly modeled include the following:

- *Corrosion* of Group 1, Fe- and Al-base metal/alloys;
- *Biodegradation* of Group 4, Cellulose and Solidified Organics and of Group 5, Rubber and Plastics;
- *Dissolution* of Group 6, MgO Backfill;
- *Cementation* of all materials; and
- *Encapsulation* of all materials.

Although fragmentation might have an effect on the particle sizes of cellulose, the expert panel concluded that this was relatively insignificant and could be ignored. Although crushing of friable materials may occur due to room closure, this will occur primarily during the first 100 years after repository closure (which is not of interest because inadvertent intrusion is effectively precluded during the 100-year active institutional controls period). Hence, the effects of crushing are considered as part of the initial conditions and not further evaluated.

The extent of a process is a function of time and is uncertain for any location (due to ignorance and variability among locations), and may possibly be correlated with each other and among locations, depending on the scale of interest. A summary discussion of each of the main processes is provided below.



4.1.3.1 Corrosion

It is assumed for this model that uniform corrosion occurs (i.e., Δr is the same for all particles¹) and a portion of the corroded materials will precipitate out as small particles, depending on available pore space. The change in particle size distribution is determined by the predicted extent of corrosion and its byproducts.

4.1.3.2 Biodegradation

It is assumed for this model that uniform biodegradation occurs (i.e., Δr is the same for all particles¹) and that the amount of particulate byproducts is small and does not significantly modify the particle size distribution. The change in particle size distribution is determined by the predicted extent of biodegradation.

4.1.3.3 Dissolution

It is assumed for this model that uniform dissolution occurs (i.e., Δr is same for all particles¹) and a portion of the dissolved materials precipitate out as small particles, depending on available pore space. The change in particle size distribution is determined by the predicted extent of dissolution and its byproducts.

4.1.3.4 Cementation

It is assumed for this model that corrosion products, dissolved MgO and salt from brine that do not precipitate out as particulates will cement other particles together (regardless of material type). Smaller particles are more likely to aggregate, with the likelihood assessed to be approximately inversely proportional to volume. If this is the case, the change in particle size distribution is determined by the amount of corrosion, MgO dissolution, and salt precipitation, and the portion of non-particulate byproducts.

4.1.3.5 Encapsulation

It is assumed for this model that the salt-intrusion front into the waste will be approximately the same as room closure if the waste were not there. All particle sizes are equally likely to be encapsulated, which

¹ The rates for corrosion, biodegradation and dissolution have been assumed to be uniform and independent of size, that is, the rates are equal to Δr , where r is the radius of the particle. Subsequent to the expert panel discussions, one of the panel members pointed out that in actuality, the rate of these reactions will decrease as the diameter of the particles decrease from their initial radii to smaller radii. For purposes of the Decomposition Model, this decrease in reaction rate with radius is considered a second-order effect and is not incorporated into the current model.

will produce a single large particle. The change in the particle size distribution is determined by the total volume encapsulated.

4.2 Algorithms

As discussed in Section 4.1, various materials will be emplaced in the repository and, over time, may be affected by various processes to various degrees. If the effect of each process on each material is approximately independent of other processes and other materials, they can be analyzed separately and then subsequently combined.

The pervasive reduction processes (i.e., corrosion, biodegradation, and dissolution) are all assumed to occur at a rate proportional to surface area (i.e., Δr is the same for all particles for each process, but may differ among processes). In this case, the diameter (or radius) for various cumulative frequencies is reduced appropriately, with the cumulative frequency staying the same. Hence, as shown in Figure 4-5, the initial frequency distribution is simply shifted to the left.

The effects of multiple processes on particle sizes are assumed herein to be additive, but otherwise independent. This is reasonable because any material is subject to only one reduction process (if any), and then possibly subject to both cementation and encapsulation. In this case, the volumes of various particles are increased appropriately from the previously reduced value. Hence, as shown in Figure 4-6, the previously modified frequency distribution is shifted.

Once the population of particle diameters has been determined for each material, they can be combined with the relative percentage of each material to determine the population of particle diameters for the composite material. As illustrated in Figure 4-7, this would be done as follows:

$$|F\{d\}| = \sum_i w_i |F\{d\}|_i$$

where

$|F\{d\}|$ is the modified population of particle diameters for the composite waste due to all processes,

$|F\{d\}|_i$ is the modified population of particle diameters for material type i due to all processes, and

w_i is the percentage of the composite material that is comprised of material type i

The above algorithms have been implemented in an EXCEL 5.0 spreadsheet (Microsoft), which is presented in Appendix B.

4.3 Model Parameters

Based on the discussions presented in Section 4-1, a comprehensive and mutually exclusive list of material groups and processes was developed. Various materials which degrade in a similar manner to each process were combined in a group and subsequently treated as one material, with their initial amounts and particle size distributions integrated, as discussed in Section 4.2.

Based on the algorithms presented in Section 4.2 and summarized in Figure 4-8, the following parameters must be assessed in order to estimate the waste particle diameters:

- The initial amount and population of particle diameters for each material group;
- The extent of each process to which each material group has been exposed, which is provided by PA (Section 2.3); and
- The partitioning of dissolved materials into particulates and cementation products, and the effects of cementation and encapsulation on particle size.



4.4 Variability and Uncertainty

As discussed in Section 2.4, there will be variability in the various model input parameters at different locations in the repository, depending on each parameter's volumetric scale. This variability in the value of parameter x can be expressed in terms of a "frequency distribution" of the values at that scale throughout the repository, $f\{x\}$, which in turn might be described in terms of an average value $m\{x\}$ and a standard deviation $s\{x\}$ in conjunction with a distribution "form" (e.g., lognormal). For example, if the parameter values at this scale are uniform throughout the repository, they would all equal the average value and the standard deviation would be zero. Similarly, as the volumetric scale of the parameter increases, all the values tend to converge towards the average value and the standard deviation tends to decrease towards zero.

In addition to spatial variability, there will typically be uncertainty in the frequency distribution of parameter values throughout the repository. If the form of this frequency distribution is known, this uncertainty can be expressed in terms of a "probability distribution" for the combination of the average value and the standard deviation, $p[m\{x\}, s\{x\}]$. Hence, a random value of parameter x (e.g., at a random location of a borehole intrusion) could be obtained by simulating $m\{x\}$ and $s\{x\}$ from $p[m\{x\}, s\{x\}]$, and then simulating x from $f\{x\}$, which is defined by the simulated values of $m\{x\}$ and $s\{x\}$ in conjunction with the distribution form.

However, there may be "correlations" in the values of different parameters at the same location in the repository, so that the parameters cannot be simulated independently. In this case, "correlation coefficients" or "conditional" probability distributions must be defined that express this relationship. The value of a "dependent" parameter can then be simulated based on the simulated value of the "independent" parameter in conjunction with either (a) the dependent parameter's "marginal" probability distribution and the correlation coefficient, or (b) the dependent parameter's conditional probability distribution. For example, the extent to which different materials have been exposed to a particular process may be very uncertain but very similar (highly correlated) for all materials.

The uncertainty in the population of particle sizes at a random location can be determined by simulating the various model parameters (as discussed above) and implementing them in the model many times. This can be done by Monte Carlo simulation using the EXCEL 5.0 spreadsheet presented in Appendix B, with commercially available @RISK3.1 (Palisade) attached as an add-in.

In the current decomposition model, the relative amounts of each material group and the repository conditions are specified as input parameters. The uncertainty in the predicted repository conditions can be propagated through the decomposition model in various ways (implementation is outside the scope of this elicitation), to determine the uncertainty in particle size populations. Although currently, these are large (repository) scale average conditions, they (as well as the relative amount of each material group) could include the additional uncertainty due to variability at smaller (drum) scale. These uncertainties in the waste mix and in the predicted repository conditions at that scale can then be propagated through the

decomposition model in the same way as is done for the uncertainty in large scale repository conditions. It should be noted that it is assumed that the initial particle size distribution for each material group and the effects of a process (given its extent) are scale-independent, and their uncertainties are insignificant relative to the uncertainties in the future repository conditions and, at small scale, in the waste mix.

As discussed in Section 2.4, the variability in the waste mix at small scale can be described in various ways. However, because of the nature of waste emplacement (i.e., in individual containers), a convenient way to describe such variability is in terms of a representative set of possible waste mixes at the drum (smallest) scale. Each waste mix would be described in terms of the percentage of each material group. In addition to the possible waste mixes, the relative frequency of each waste mix in the repository (i.e., in terms of percent by volume) and the number of drums containing similar wastes which are packaged together would be estimated. For any scale, the appropriate number of drums would be randomly sampled (in Monte Carlo simulation) and their simulated mixes combined.

4.5 Model Limitations

The decomposition model described above has some limitations. For example, it has been assumed that the effects of the various processes on the particle size distributions of the various material groups are approximately independent, and can be simply combined in an additive manner.

In addition, the model considers the effects of the various predicted processes on a specified combination of waste materials. Currently, a combination of materials and repository conditions which represent the large (repository) scale average is used. However, as discussed in Section 4.4, at the scale of interest, there will be significant variability in both the material combinations and in the repository conditions, and the average condition would actually be very unlikely. If necessary, such variability in the initial waste amounts and in the future repository conditions, if quantified, can be easily incorporated in the current decomposition model as discussed in Section 4.4. The need to determine such variability and the implementation of the decomposition model in PA is outside the scope of this elicitation.



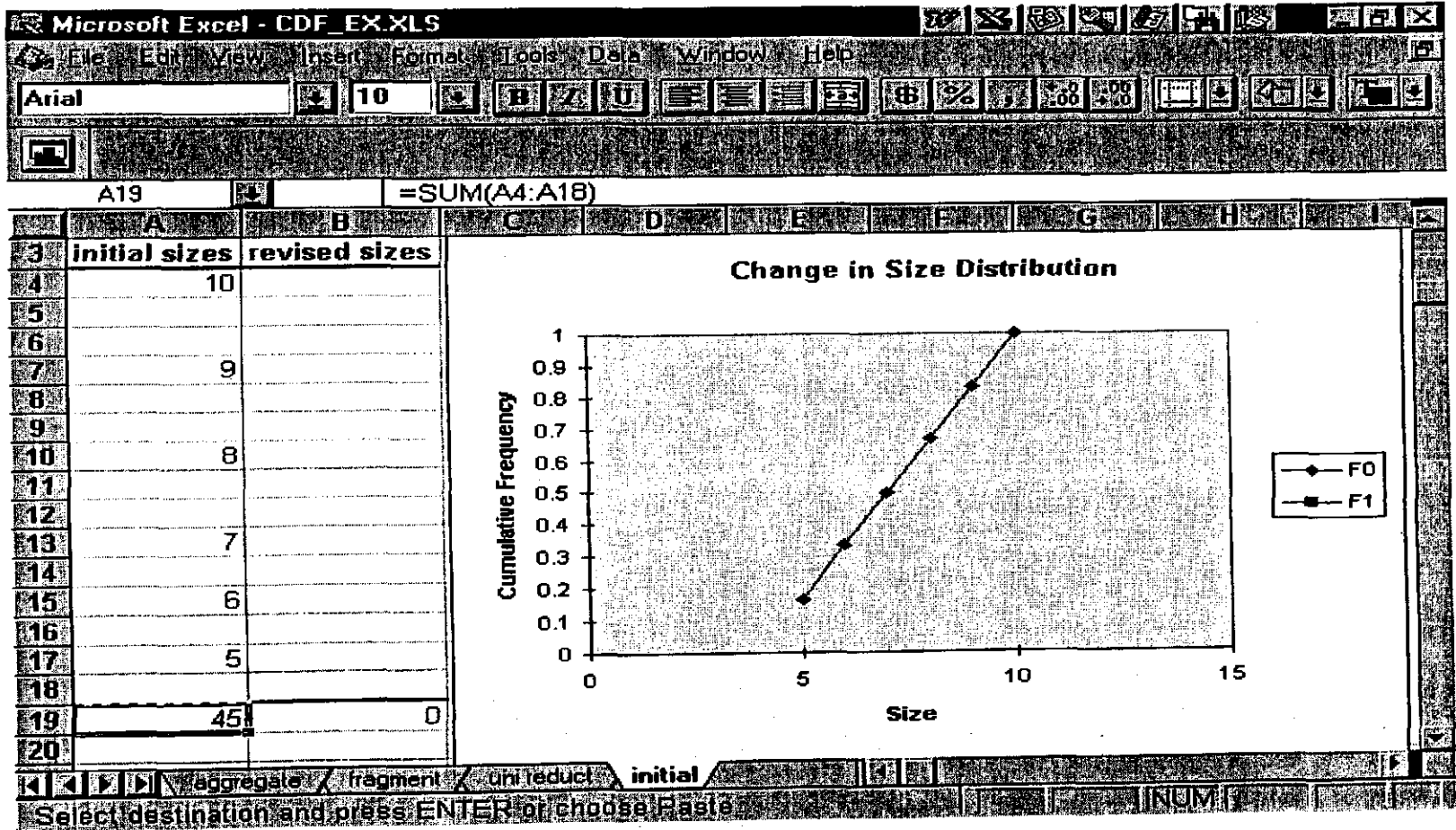

M

Figure 4-1 Example - Initial Distribution

Information Only

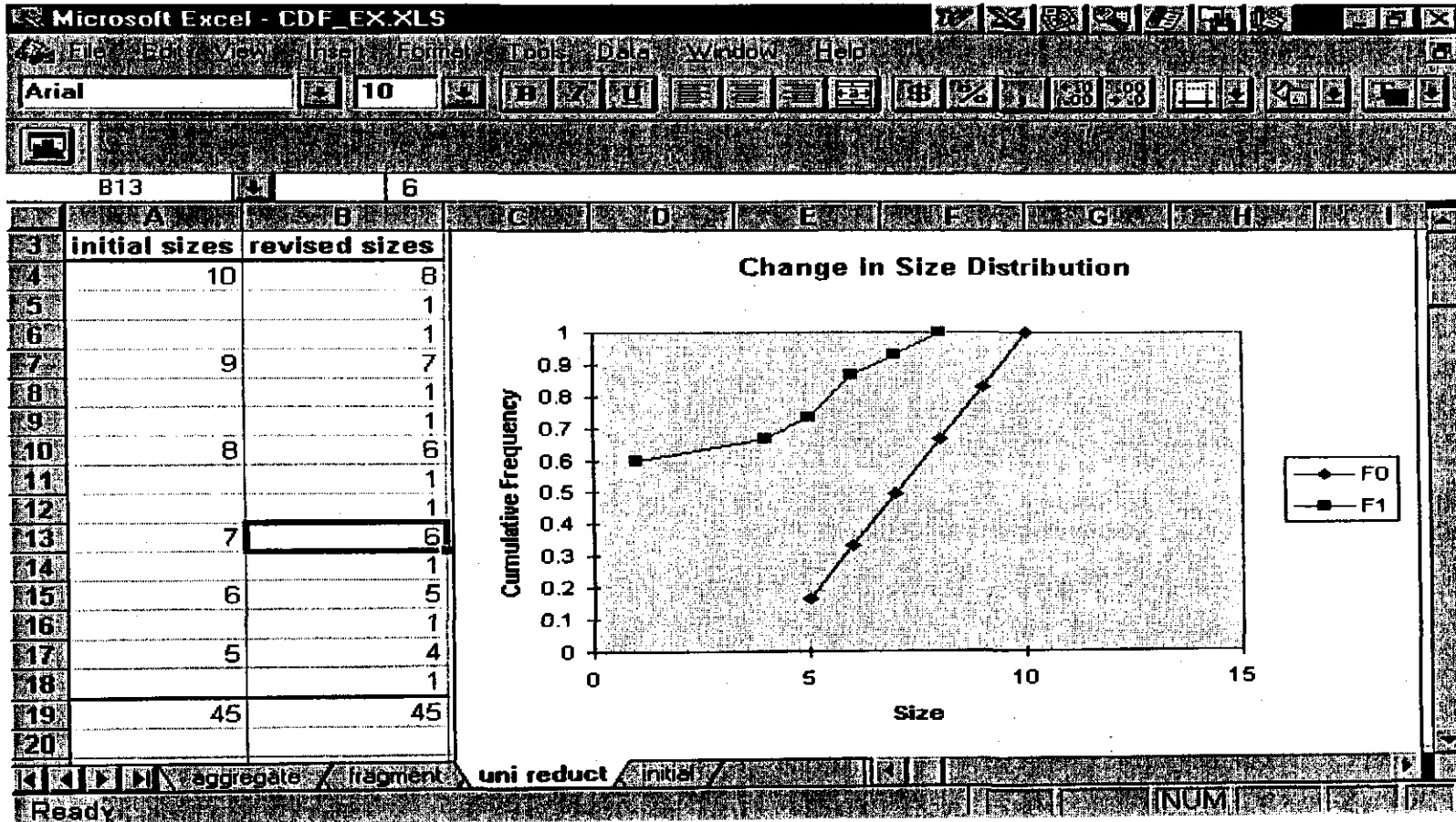

Figure 4-2 Example - Pervasive Reduction

Information Only

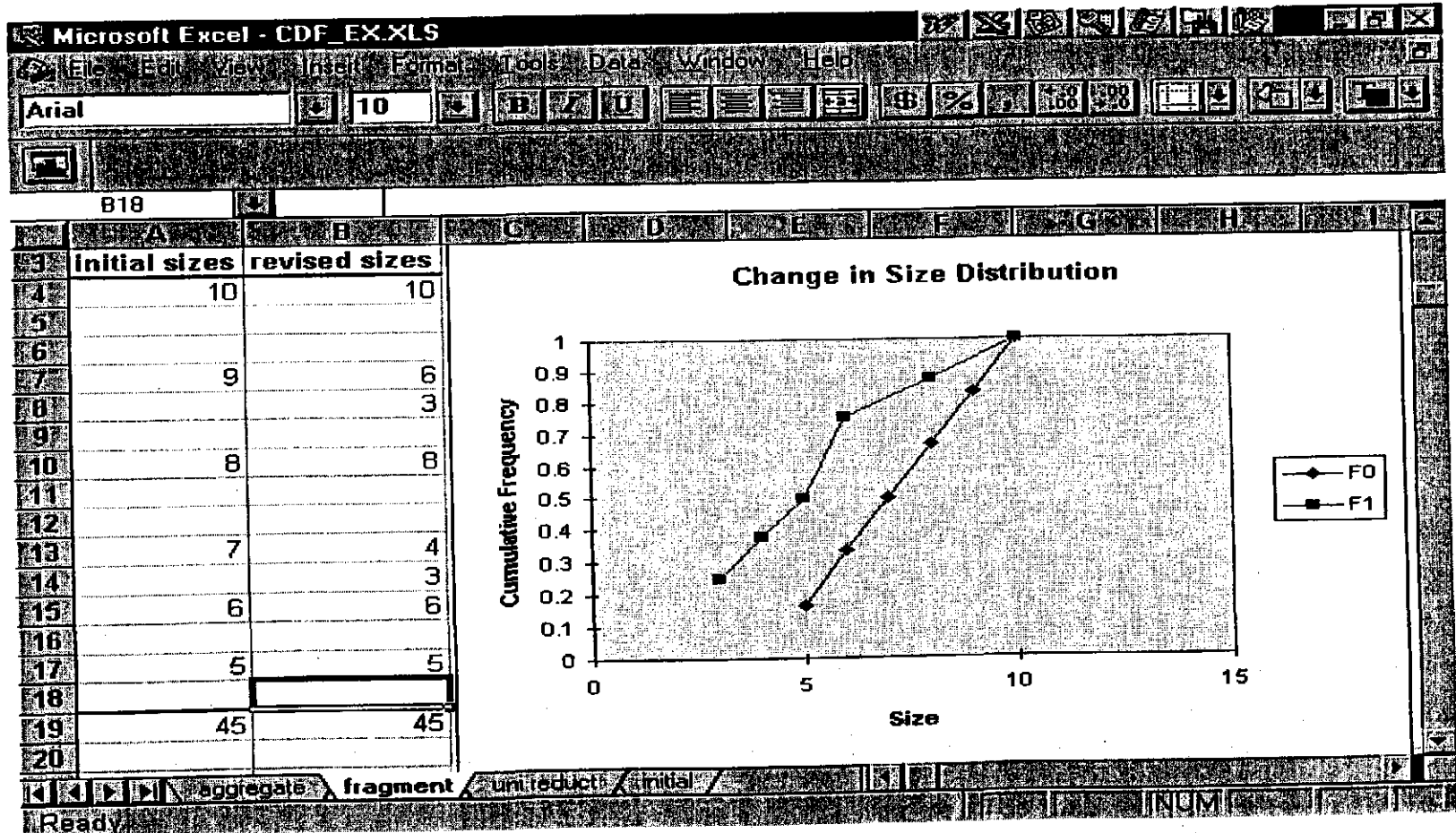

Figure 4-3 Example - Selected Reduction

Information Only

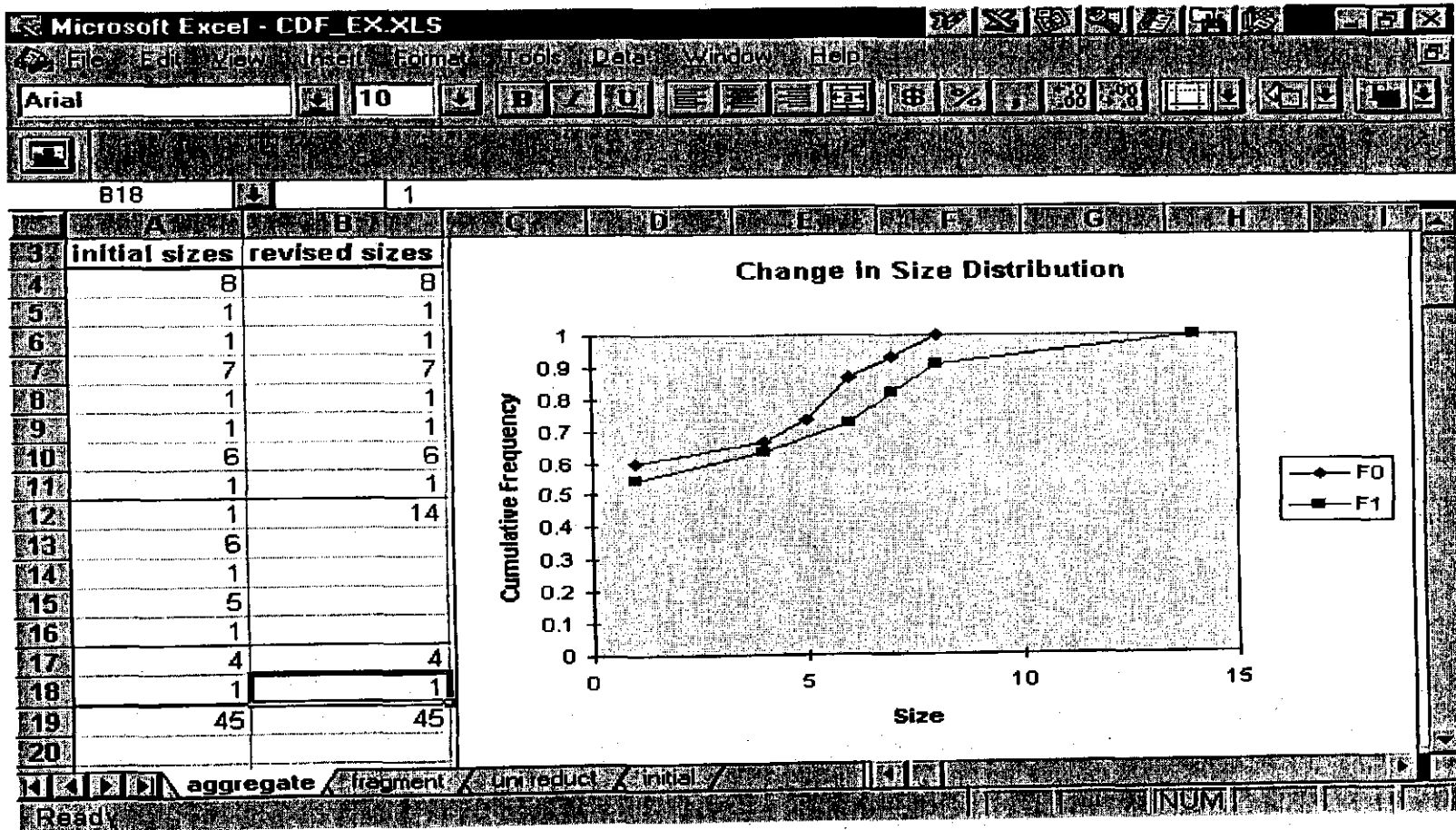
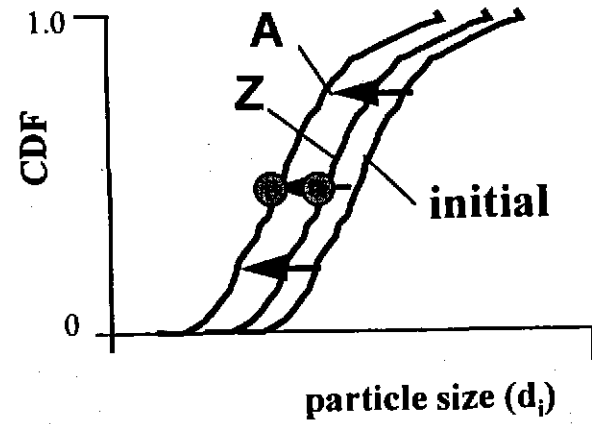
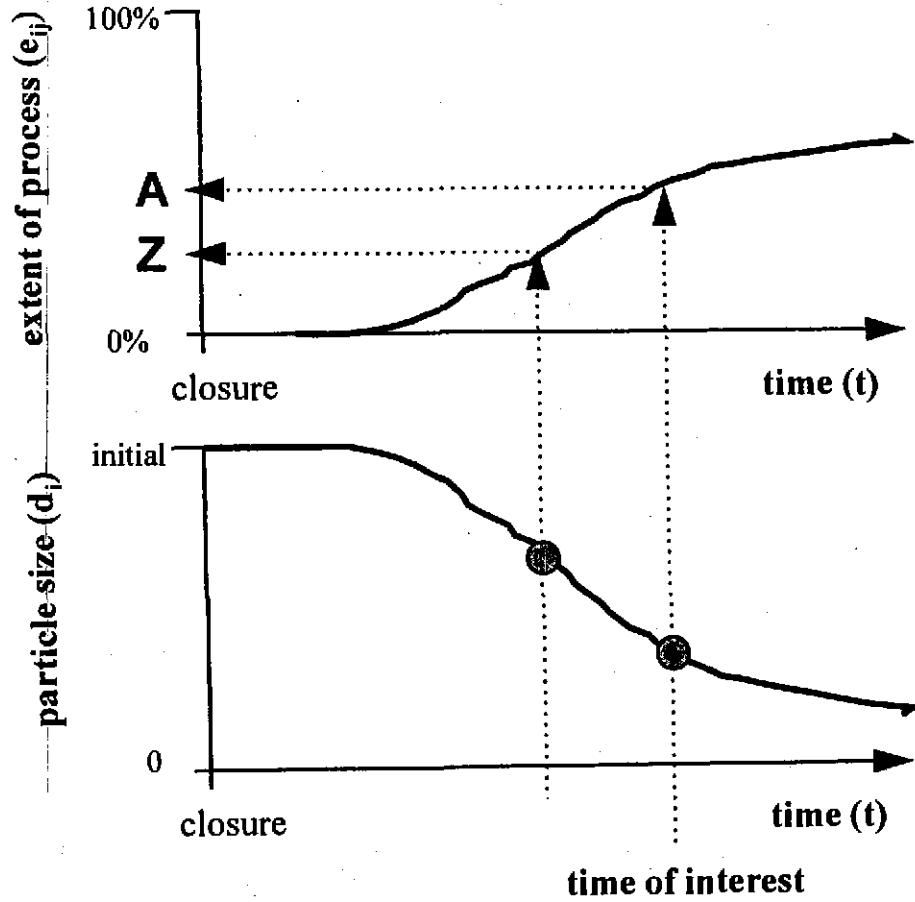

Figure 4-4 Example - Aggregation

Information Only



Note: particle size is in terms of any percentile value

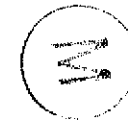
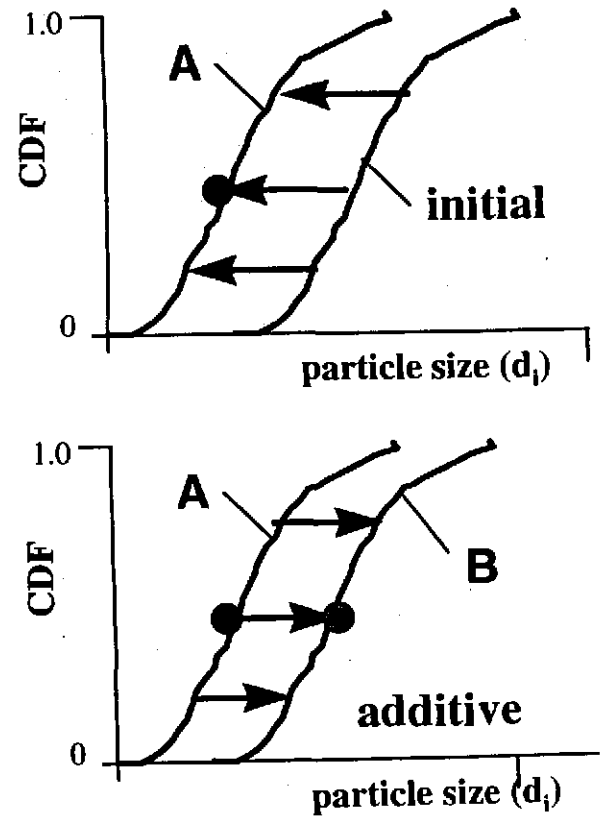
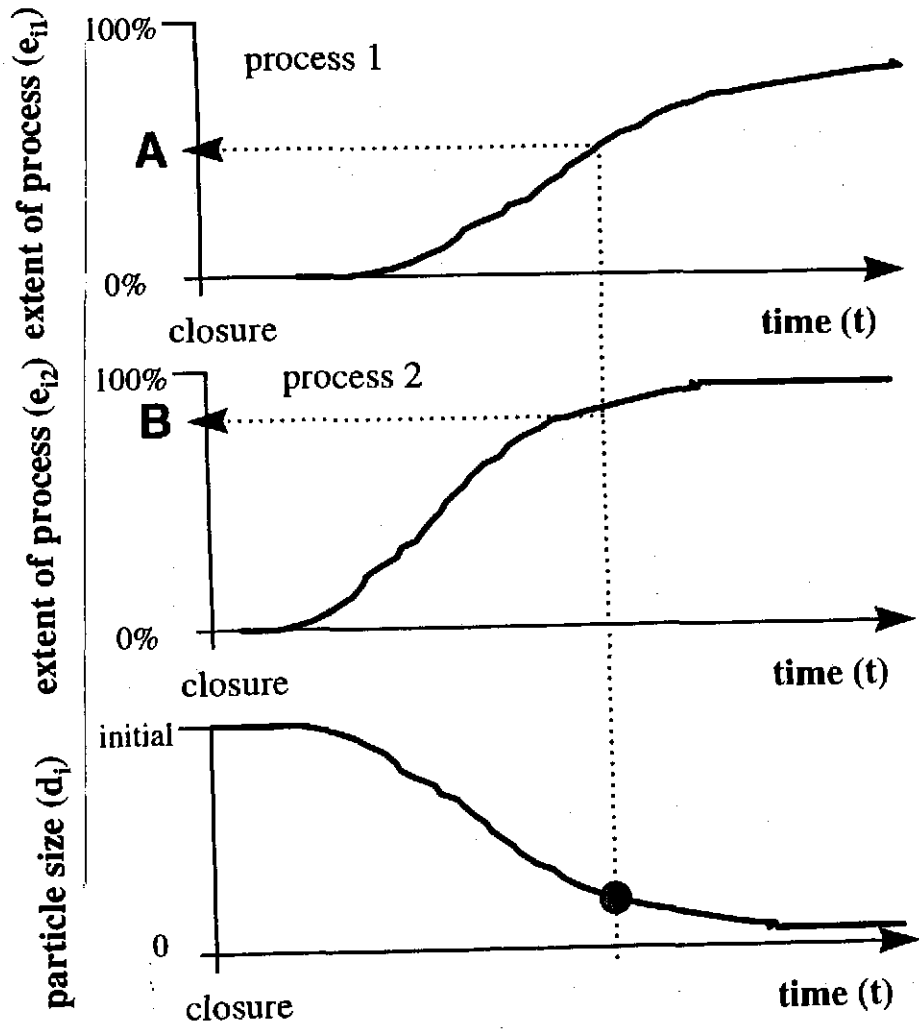
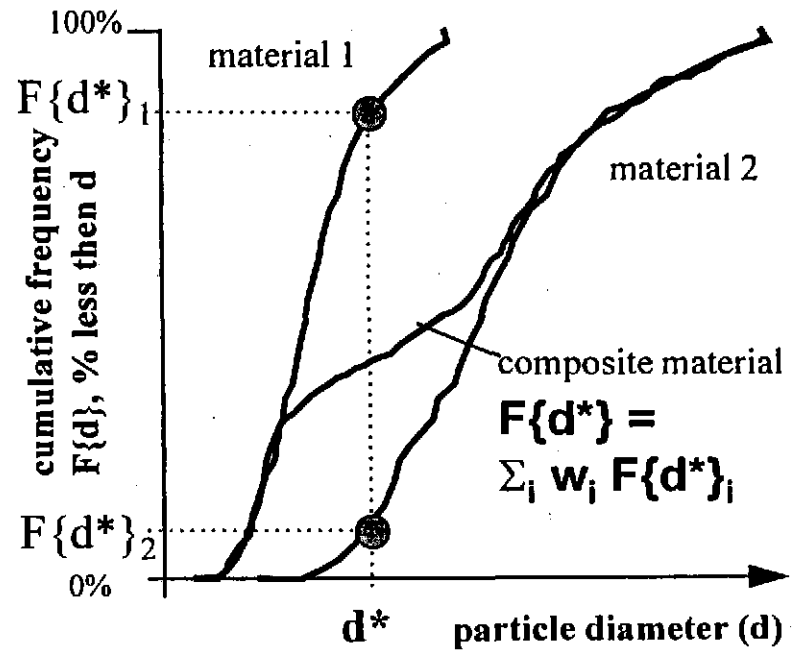
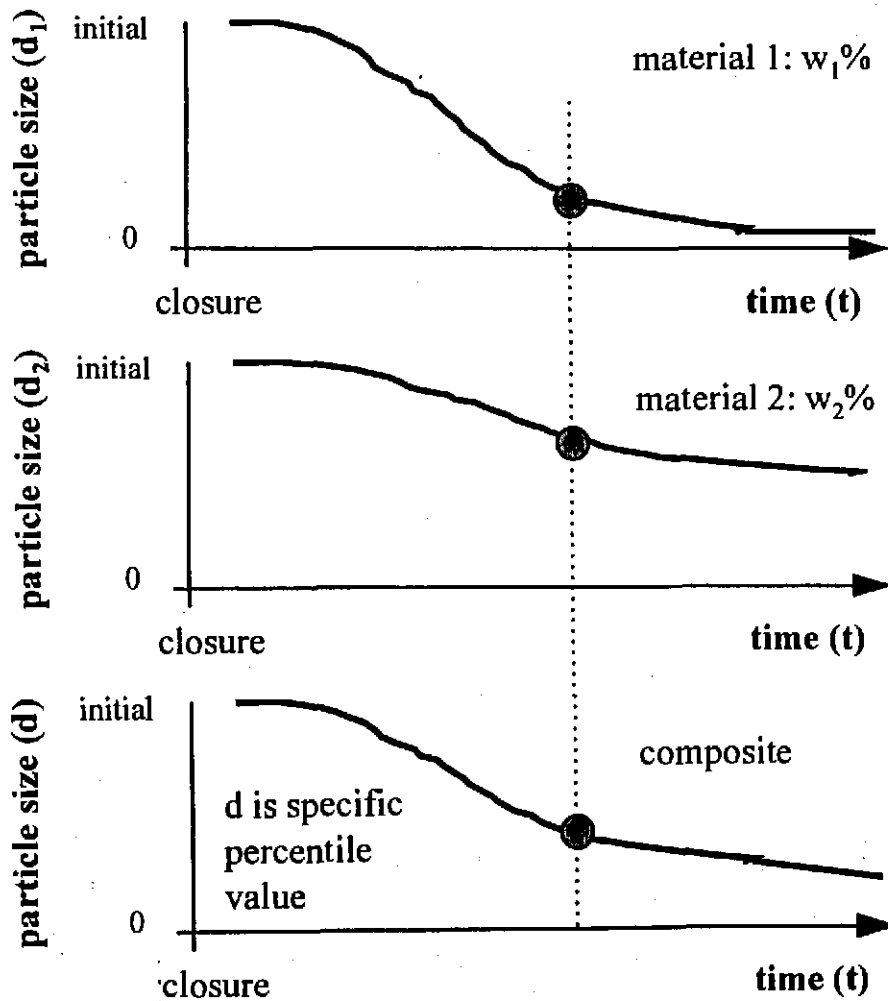

Figure 4-5 Prediction of Particle Size - One Material and One Process



Note: particle size is in terms of any percentile value

Figure 4-6 Prediction of Particle Size - One Material and Multiple Processes



Note: particle size is in terms of any percentile value



Figure 4-7 Prediction of Particle Size - Multiple Materials and Processes

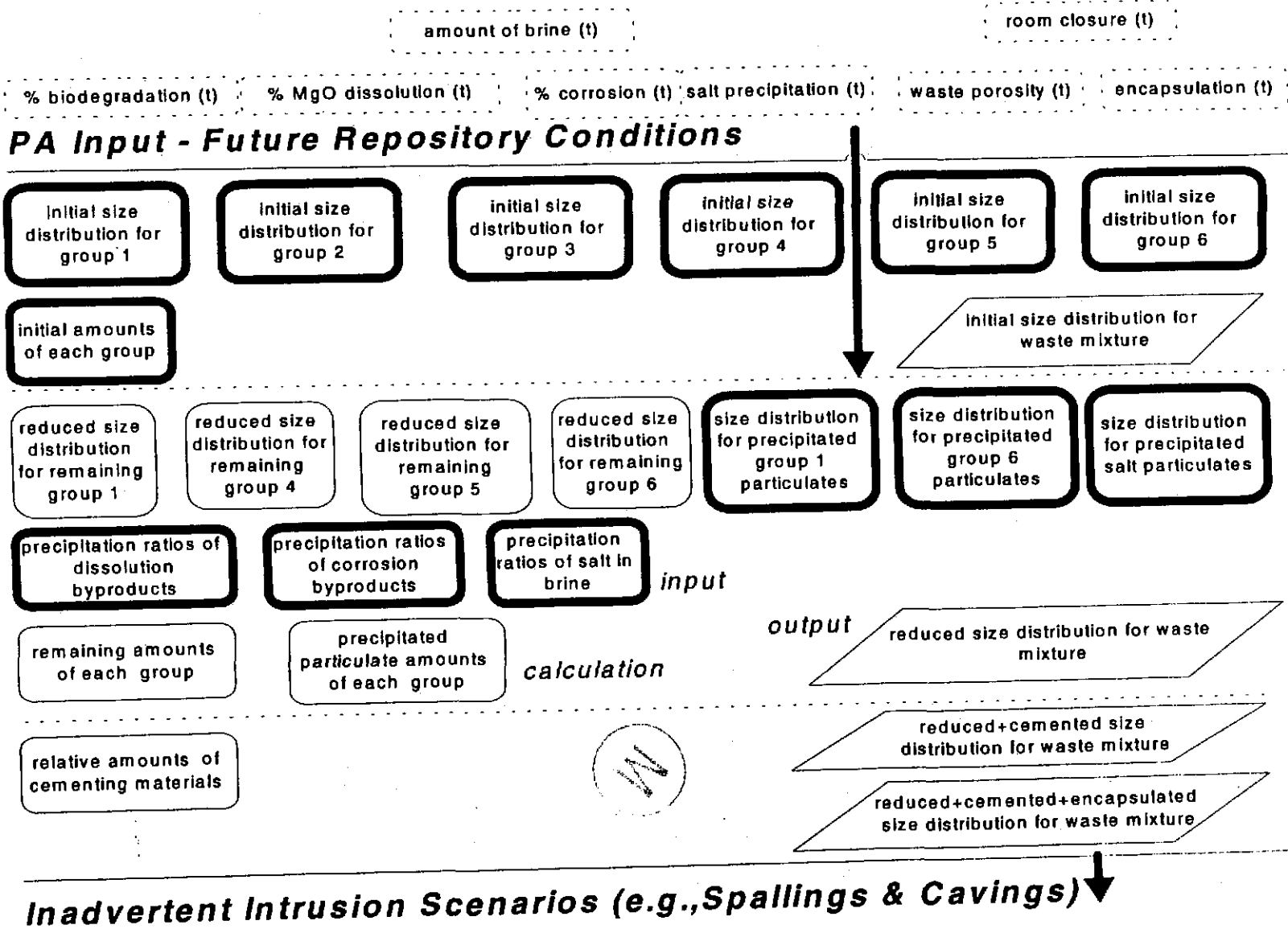

Figure 4-8 Decomposition Model Schematic

Information Only



5. Parameter Assessments

This section presents the expert panel's assessment of each model parameter defined in Section 4. These parameters relate to: the variability in initial particle sizes for each material group, including upper and lower bounds; the effects of processes on particle size for each material group; the amount of each material group involved; and the relevant repository conditions. The experts' assessments are documented in Appendix C.

5.1 Initial Particle Size Population

The types of materials and their overall amounts in each group were identified (DOE 1996b), and their average particle size and percent of total amount were estimated based on judgment (consistent with Clements & Kudera [1985], as discussed by the EEG on May 6, 1997, and with a video of Idaho National Engineering and Environmental Laboratory [INEEL] drum sampling program). In addition, the bounds (especially the lower bound) in particle size for each group were estimated. Cumulative frequency distributions (CDFs) and complementary CDFs (CCDFs) of initial particle volume (m³) were then developed for each group, appropriate for large scale, by summing the percentages for all sizes less than or equal to the particular value. A continuous curve (i.e., piece-wise power law, which is piece-wise linear when log volume is plotted versus log complementary cumulative frequency) was fitted to the data, including the assessed minimum size.

The particle sizes of each of the various material groups are discussed below.

5.1.1 Iron- and Aluminum-Base Metal/Alloys

The panel estimated that this material group ranges in size from shavings (1 mm in diameter) to steel plug (0.3 m³). The various materials comprising this group, and their approximate percentages and average particle sizes, are summarized in Table 5-1. The CCDF of particle sizes for this material group is presented in Figure 5-1. This CCDF can be expressed as:

$$1-F\{v\} = \begin{cases} \{1.0E-6/v(m^3)\}^{0.88} & \text{for } v > 10^{-6} \text{ m}^3 \\ \{1.0E-9/v(m^3)\}^{0.0043} & \text{for } v < 10^{-6} \text{ m}^3 \end{cases}$$

Table 5-1 Initial Particle Size Distribution - Fe- and Al-base metals

Material	Particle Volume (m ³)	Number of Particles	CDF	CCDF
waste	2.50E-07	4.00E+06	2.84E-02	9.72E-01
waste	1.00E-06	1.50E+07	1.35E-01	8.65E-01
waste	1.00E-05	8.50E+07	7.38E-01	2.62E-01
waste	1.00E-04	3.50E+07	9.87E-01	1.32E-02
waste	1.00E-03	1.10E+06	9.95E-01	5.35E-03
drum	4.50E-03	7.30E+05	1.00E+00	1.64E-04
SWB	5.00E-02	4.46E+03	1.00E+00	1.32E-04
SWB OP	6.70E-02	4.46E+03	1.00E+00	1.01E-04
canister	8.30E-02	7.10E+03	1.00E+00	5.04E-05
plugs	3.58E-01	7.10E+03	1.00E+00	1.11E-16
	total number =	1.41E+08		
	total wt (kg)* =	7.44E+07		

Note: *density for all materials is assumed to be 6 gm/cc.



5.1.2 Other Metals/Inorganic/Vitrified/Soils/Cements/Solidified Inorganics

The Panel estimated that this material group ranges in size from solid inorganic particulates (5 micron in diameter) to vitrified drum size (0.21 m³). The various materials comprising this group, and their approximate percentages and average particle sizes, are summarized in Table 5-2. The CCDF of particle sizes for this material group is presented in Figure 5-2. This CCDF can be expressed as:

$$1 - F(v) = \{1E-16/v(m^3)\}^{0.88}$$

Table 5-2 Initial Particle Size Distribution (e.g., other metals, soils)

Material	Total Mass (kg)	Density (gm/cc)	Size	Units	Particle Volume (m ³)	Number of Particles	CDF	CCDF
inorganic nonmetal - <10 micron	1.00E+04	2.5	5	micron	1.25E-16	3.2E+16	8.69E-01	1.31E-01
Pb - particulate gloves	1.56E+06	11.3	100	micron	1E-12	1.38E+14	8.72E-01	1.28E-01
inorganic nonmetal - <212 micron	1.50E+05	2.5	100	micron	1E-12	6E+13	8.74E-01	1.26E-01
soils	7.42E+06	2.2	0.1	mm	1E-12	3.37E+15	9.65E-01	3.45E-02
solidified inorganics	9.25E+06	1.3	0.2	mm	8E-12	8.89E+14	9.90E-01	1.04E-02
cement	8.56E+06	2.8	0.2	mm	8E-12	3.82E+14	1.00E+00	1.6E-09
inorganic nonmetal - intermediate	9.80E+05	2.5	2	cm	8.00E-06	4.90E+07	1.00E+00	2.74E-10
inorganic nonmetal - coarse	4.54E+06	2.5	213	cc	2.13E-04	8.53E+06	1.00E+00	4.27E-11
other alloys - crucible	2.60E+06	8	2.3	kg	2.88E-04	1.13E+06	1.00E+00	1.2E-11
Pb bricks	3.64E+06	11.3	0.001	m3	1.00E-03	3.22E+05	1.00E+00	3.27E-12
Pb 4'x2'	5.20E+06	11.3	0.005	m3	5.00E-03	9.20E+04	1.00E+00	7.75E-13
lead RH packaging	3.24E+06	11.3	0.037	m3	3.70E-02	7.75E+03	1.00E+00	5.65E-13
vitrified	9.30E+06	3	0.53	m	1.49E-01	2.08E+04	1.00E+00	0.00E+00
total wt. (kg)	5.65E+07					total number = 3.68E+16		

5.1.3 Salt (rock)

The panel estimated that this material group ranges in size from dust (1 micron in diameter) to half room-size slab 2 m thick (1000 m³), with an average value of 10⁻⁵ m³. The amount of salt fragments was estimated to be about 2% of the original room volume, based on available room porosity. The CCDF of particle sizes for this material group is presented in Figure 5-3. This CCDF can be expressed as:

$$1 - F(v) = \{1E-18/v(m^3)\}^{1.00}$$

5.1.4 Cellulosics/Solidified Organics

The panel estimated that this material group ranges in size from solidified organic particles (0.2 mm in diameter) to compressed high efficiency particulate air (HEPA) filter (1.9 m³). The various materials comprising this group, and their approximate percentages and average particle sizes, are summarized in

Table 5-3. The CCDF of particle sizes for this material group is presented in Figure 5-4. This CCDF can be expressed as:

$$1 - F\{v\} = \{1E-11/v(m^3)\}^{1.05}$$

although a separate description could be used for $10^{-11} m^3 > v > 10^{-6} m^3$



Table 5-3 Initial Particle Size Distribution (cellulosics/solidified organics)

Material	Total Mass %	Total Volume* (m ³)	Density (g/cc)	Equivalent Diameter (cm)	Particle Volume (m ³)	Number of Particles	CDF	CCDF
solidified organics (1970-1986)		980	2.0	0.002	1.00E-11	9.80E+13	0.99999	5.3E-06
solidified organics (1986-present)		172	2.0	1.0	1E-06	1.72E+08	1.00E+00	3.5E-06
Kimwipes	5%	512*	0.9	1.3	2E-06	2.56E+08	1.00E+00	9.4E-07
sm paper filters	10%	1024*	0.9	3.0	2.7E-05	3.79E+07	1.00E+00	5.5E-07
20mil 12"x12" rags	15%	1537*	0.9	3.6	4.70E-05	3.27E+07	1.00E+00	2.1E-07
10mil 10"x12" cardboard cartons	10%	1024*	0.9	4.5	9.10E-05	1.13E+07	1.00E+00	9.9E-08
HEPA filters	15%	1537*	0.9	6.6	2.90E-04	5.30E+06	1.00E+00	4.5E-08
wood frames for filters	10%	1024*	0.9	7.3	3.90E-04	2.63E+06	1.00E+00	1.9E-08
1.5 m ² coveralls/booties	10%	1024*	0.9	9.1	7.50E-04	1.37E+06	1.00E+00	4.6E-09
HEPA filters	15%	1537*	0.9	16.5	4.50E-03	3.41E+05	1.00E+00	1.1E-09
wood frames for filters	5%	512*	0.9	18.5	6.30E-03	8.13E+04	1.00E+00	2.6E-10
2'x4'x3/4" plywood	5%	512*	0.9	27.0	2.00E-02	2.56E+04	1.00E+00	0.0E+00
100%								
total weight (kg)	9.22E+06					total number = 9.8E+13		

*With the exception of solidified organics, the values for total volume are computed as the product of the particle volume and the number of particles. The number of significant figures in a value for total volume is limited by the number of significant figures in the corresponding value for particle volume.

5.1.5 Rubber/Plastics

The panel estimated that this material group ranges in size from drum filter gaskets (1cc) to 90 mil drum liners (0.03 m³). The various materials comprising this group, and their approximate percentages and average particle sizes, are summarized in Table 5-4. Based on this, the CCDF of particle sizes for this material group is presented in Figure 5-5. This CCDF can be expressed as:

$$1 - F\{v\} = \begin{cases} \{6E-5/v(m^3)\}^{1.15} & \text{for } v > 10^{-4} m^3 \\ \{1E-6/v(m^3)\}^{0.124} & \text{for } v < 10^{-4} m^3 \end{cases}$$

Table 5-4 Initial Particle Size Distribution (rubber/plastics)

Material	Particle Volume (m ³)	Number of Particles	Density (g/cc)	Total Weight (kg)	CDF	CCDF
drum HEPA Filter	1.00E-06	1.00E+06	1.14	1.14E+03	2.21E-02	9.78E-01
gaskets						
smaller plastic pieces	1.00E-05	1.46E+07	1	1.46E+05	3.44E-01	6.56E-01
rubber gloves	1.00E-04	4.00E+06	1.14	4.56E+05	4.33E-01	5.67E-01
small plastic bags	1.00E-04	2.19E+07	1	2.19E+06	9.16E-01	8.41E-02
drum gaskets	1.50E-04	7.30E+05	0.5	5.48E+04	9.32E-01	6.80E-02
SWB gasket	4.50E-04	8.92E+03	0.5	2.01E+03	9.32E-01	6.78E-02
Pb rubber gloves	1.00E-03	1.00E+06	1.14	1.14E+06	9.54E-01	4.57E-02
large plastic bags	1.00E-03	1.46E+06	1	1.46E+06	9.87E-01	1.35E-02
Pb rubber aprons	4.00E-03	1.00E+04	1.14	4.56E+04	9.87E-01	1.35E-02
90mil HDPE liner	7.70E-03	6.00E+05	1	4.62E+06	1.00E+00	0.00E+00
total number =		4.53E+07		total wt (kg) =	1.01E+07	

5.1.6 MgO Backfill

The panel estimated that the MgO backfill has a constant particle size, based on the limited range of MgO pellet diameters in comparison to the broad range of particle sizes for TRU waste. For example, the MgO pellets for recent experimental studies have a range of 0.5 to 4 mm (SNL, 1997b). With this assumption, the CCDF for the MgO backfill can be expressed as:

$$1 - F(v) = \begin{cases} 0 & \text{for } v > 10^{-9} \text{ m}^3 \\ 1 & \text{for } v < 10^{-9} \text{ m}^3 \end{cases}$$



5.2 Effects of Processes

In addition to initial particle size distributions for each material group (Section 5.1), the byproducts of corrosion and dissolution were estimated by the expert panel as follows:

- Most of corrosion and MgO-dissolution byproducts will precipitate out as cementing agents, with the remainder precipitating out as free particulates. As shown in Figure 5-6, it was assessed by the panel that a maximum of 25% of the corrosion and MgO-dissolution byproducts will precipitate out as free particulates, and that this percentage will decrease to zero as the remaining available porosity decreases towards zero. It was also estimated by the panel that the free particulates will range in size from 0.1 to 10 microns, with an average value of 2 microns.
- Even more of dissolved salts (from brine) will precipitate out as cementing agents, with the remainder precipitating out as free particulates. As shown in Figure 5-6, it was assessed by the panel that a maximum of 10% of the dissolved salts will precipitate out as free particulates, and that this percentage will decrease to zero as the remaining available porosity decreases towards zero. It was estimated that the free particulates will range in size from 0.1 to 10 microns, with an average value of 2 microns.

- As shown in Figure 5-7, it was estimated by the panel that the particle sizes would approach room size (i.e., a cemented mass) as the cement volume approached about 40% of the pore space (assuming about a 25% porosity prior to cementation), and that the range in particle sizes would also decrease.

5.3 Amounts and Distribution of Materials

As summarized in Table 5-5, the relative amount of each material group at the large (repository) scale has been assessed in various ways:

- By combining the weight percentage of the more detailed materials (Table 2-1) with the categorization of each of those materials (Table 4-1), the weight percentage of each material group were determined (in the particle size distribution model). This should be consistent with the total weights for each material group presented in Tables 5-1 through 5-4.
- By summing the products of each particle volume and the number of particles of that size for each material group, as presented in Tables 5-1 through 5-4, the total volume for each material group was determined. The volume for salt and MgO backfill were estimated by the experts separately.

Although these amounts are appropriate for large scale, there will be significant variability at small (e.g., individual drum) scale. Ideally, as discussed in Section 4.4, the variability in amounts at the scale of interest would be assessed quantitatively. However, in lieu of such quantitative assessments, the variability can be discussed only qualitatively, as also summarized in Table 5-5.

Table 5-5 Amount and Distribution of Material

Material Group	Wt %	Wt (kg)	Vol (m ³)	Vol (%)	Spatial Variability		Location
					Lateral	Vertical	
Fe- and Al-base metals	28.9	7.4E+07	1.24E+04	14.3	waste container	waste container	every container
Other metals/soils/etc.	22.1	5.7E+07	2.04E+04	23.5	variable*	waste container	variable*
Salt	9.1	2.3E+07	1.04E+04	12.0	room seals	top of room	throughout
Cellulosics/Solidified organics	4.0	9.2E+06	1.14E+04	13.1	variable**	waste container	variable**
Rubber/plastics	4.6	1.0E+07	9.93E+03	11.5	waste container	waste container	every container
MgO backfill	31.3	8.1E+07	2.21E+04	25.5	sides of room	top of room	throughout (except RH)

*The solidified inorganics/soils/vitrified are variable at the 7-drum pack/SWB and the other materials (Table 2-1) are variable at the waste container

**The cellulosics are variable at the waste container and the solidified organics at 7-drum pack/SWB

5.4 Repository Conditions

The prediction of the extent to which each process has occurred as a function of time is outside the scope of this elicitation. It is assumed that PA will predict the relevant repository conditions and their uncertainty including:

- the extent of corrosion of Fe- and Al-base metals;
- the extent of biodegradation of cellulosics/solidified organics;

- the extent of biodegradation of rubber/plastics;
- the extent of MgO dissolution;
- the porosity of the waste;
- the amount of precipitated salt; and
- the amount of salt encapsulation.



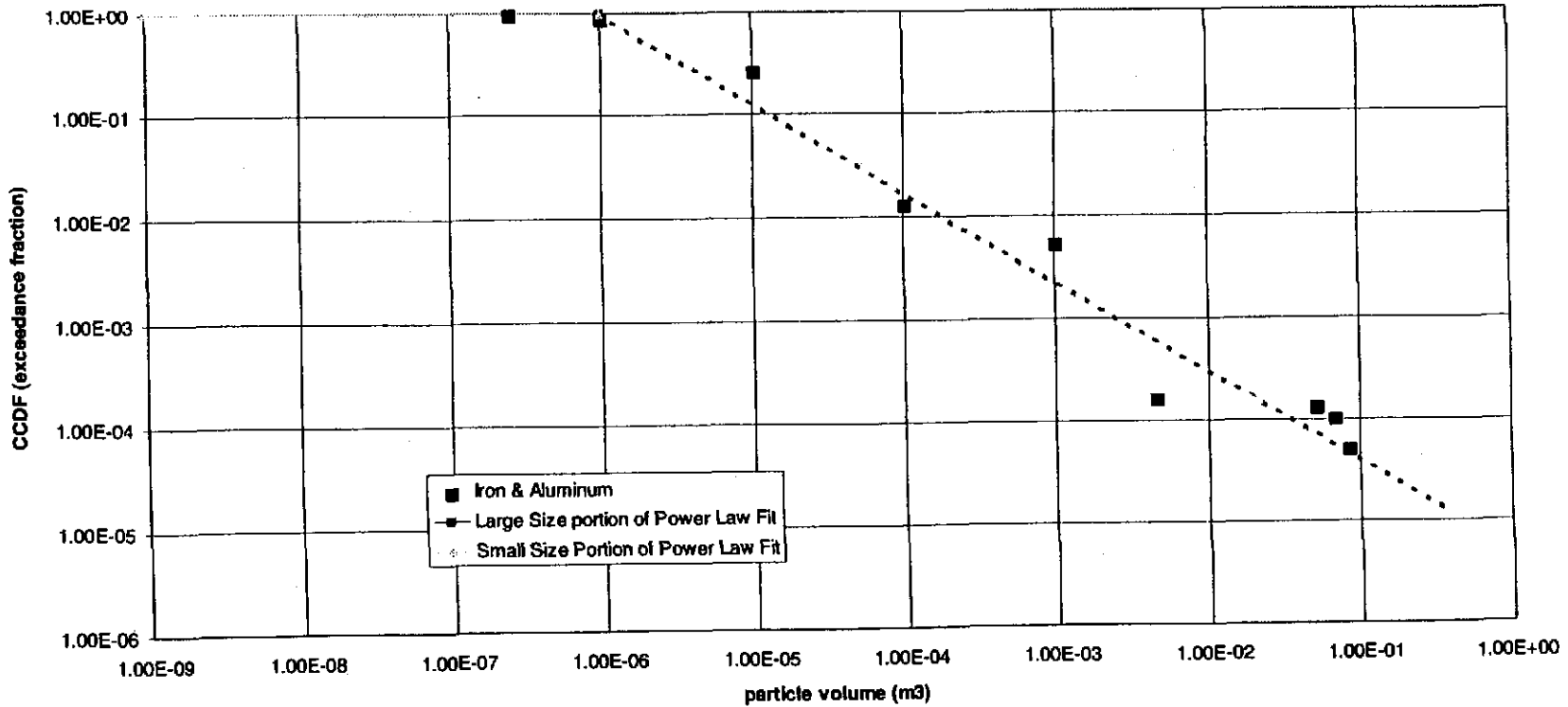

$$\begin{aligned}
 1-F\{v\} &= \{1.0E-6/v(m^3)\}^{0.88} \text{ for } v > 10^{-6} \\
 &= \{1.0E-9/v(m^3)\}^{0.0043} \text{ for } v < 10^{-6}
 \end{aligned}$$



Figure 5-1 Initial Particle Size Population - 1. Fe&Al-Base Metals

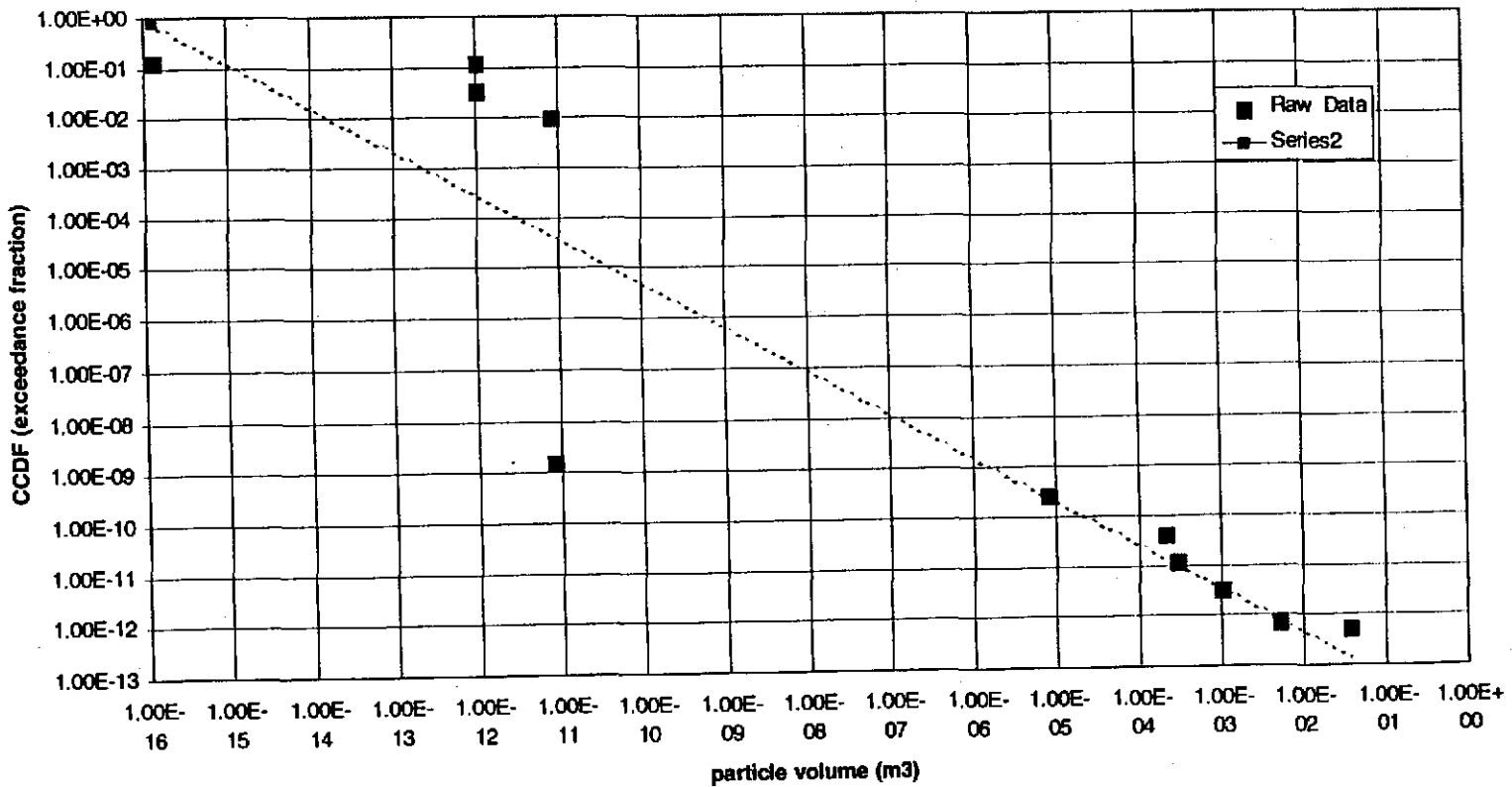

$$1 - F\{v\} = \{1E-16/v(m^3)\}^{0.88}$$

W

Figure 5-2 Initial Particle Size Population - 2. Other Metals/Soils/etc.

Information Only

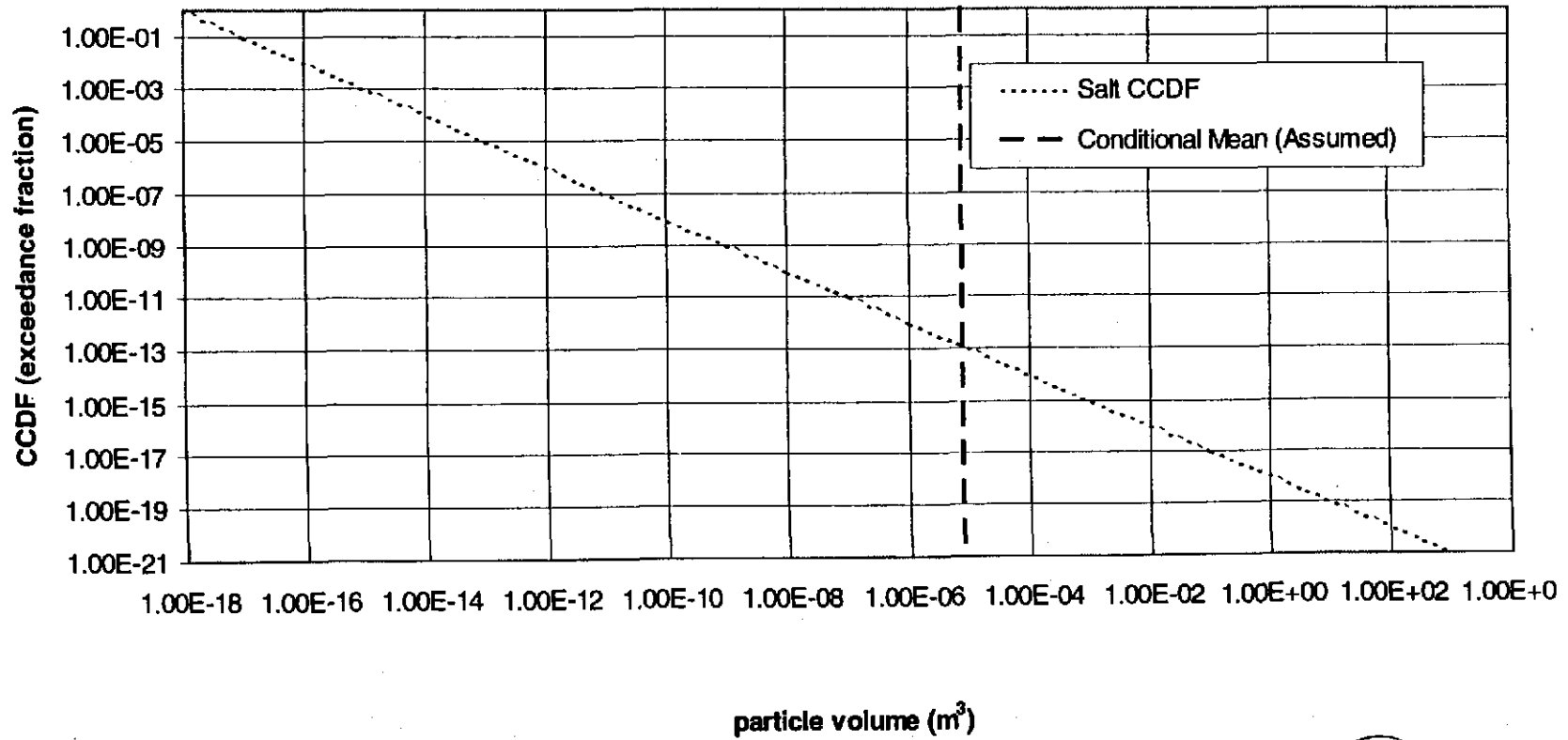

$$1 - F\{v\} = \{1E-18/v(m^3)\}^{1.00}$$



Figure 5-3 Initial Particle Size Population - 3. Salt

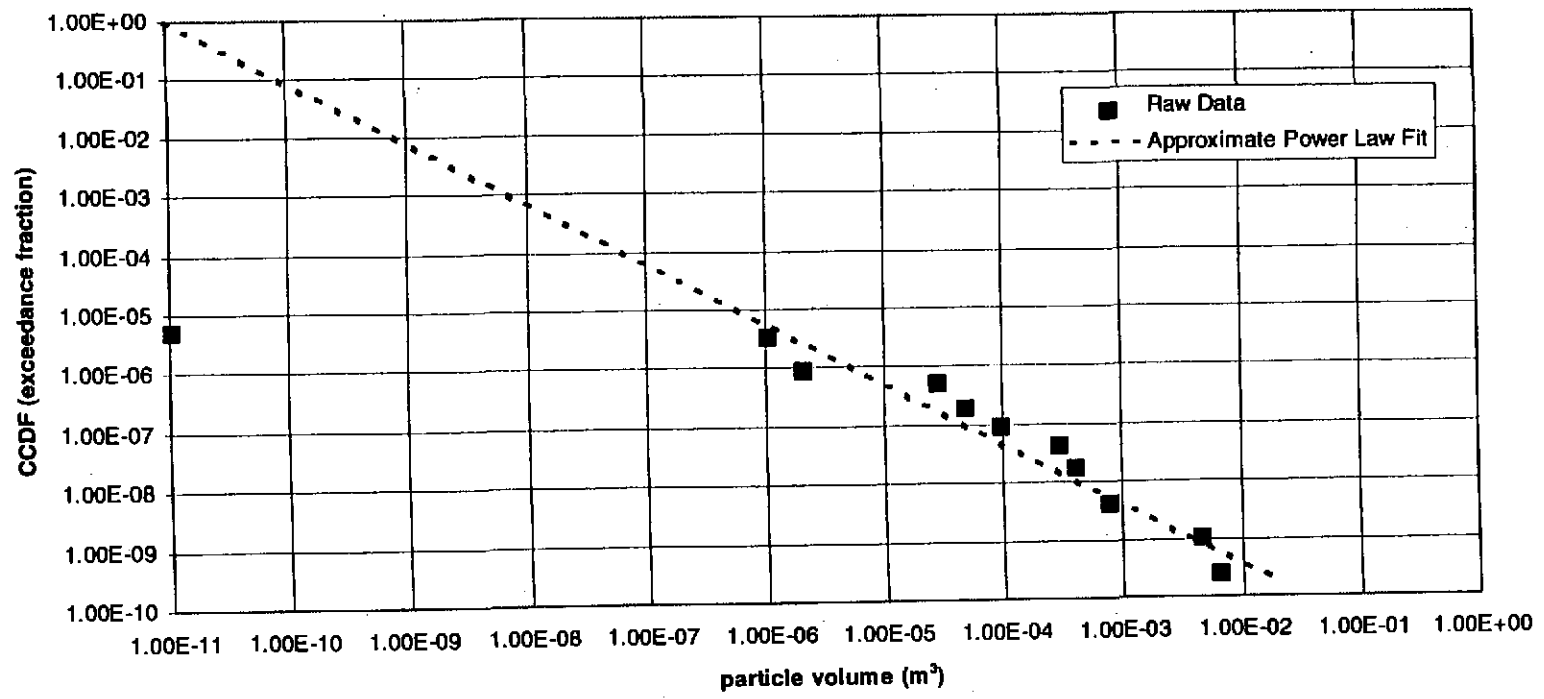

$$1 - F\{v\} = \{1E-11/v(m^3)\}^{1.05}$$

although could use separate description for 10^{-11} to 10^{-6}

Figure 5-4 Initial Particle Size Population - 4. Cellulosics/Solidified Organics

Information Only

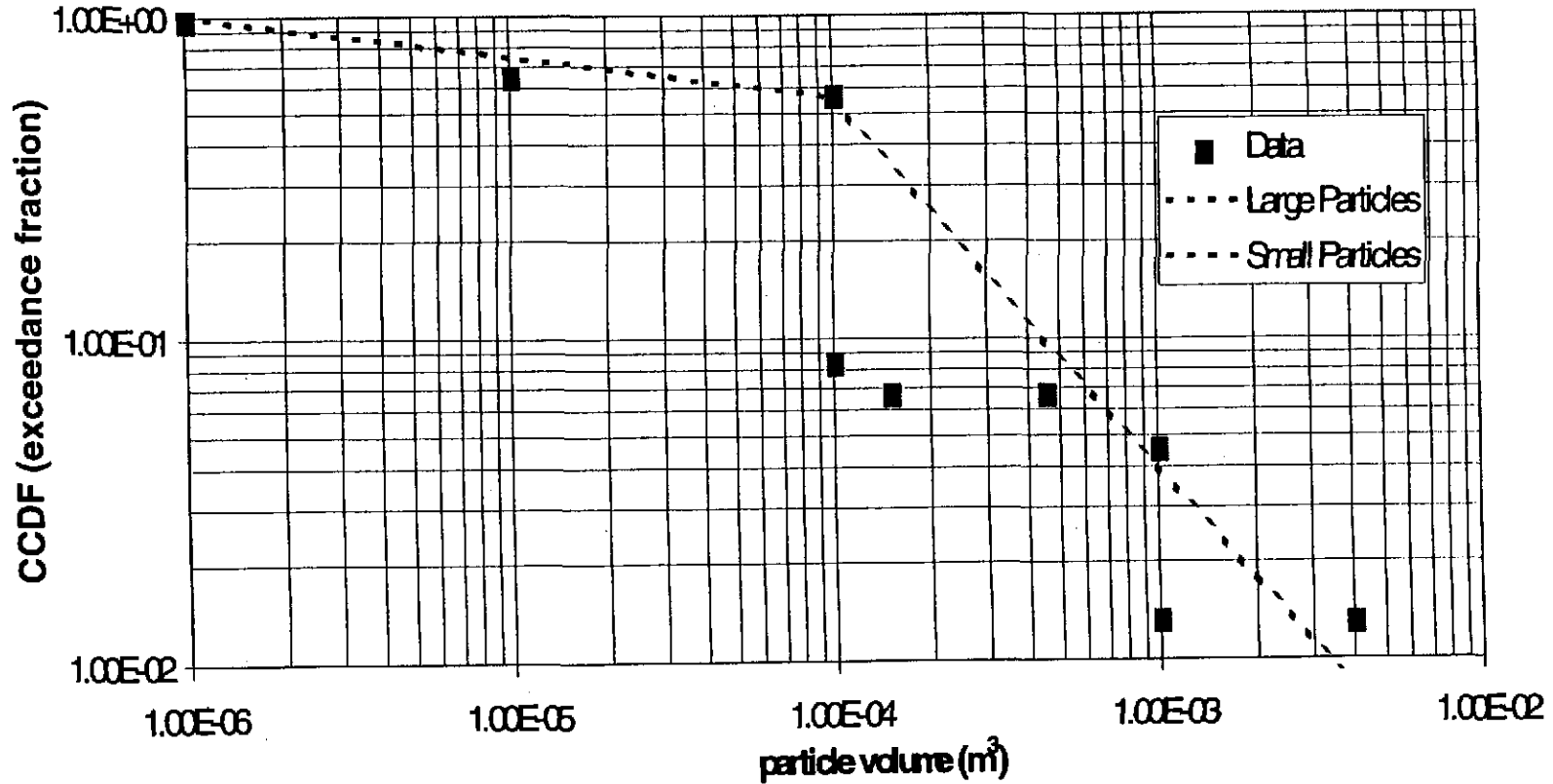

$$\begin{aligned}
 1 - F\{v\} &= \{6E-5/v(m^3)\}^{1.15} \text{ for } v > 10^{-4} \\
 &= \{1E-6/v(m^3)\}^{0.124} \text{ for } v < 10^{-4}
 \end{aligned}$$

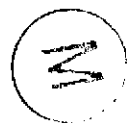
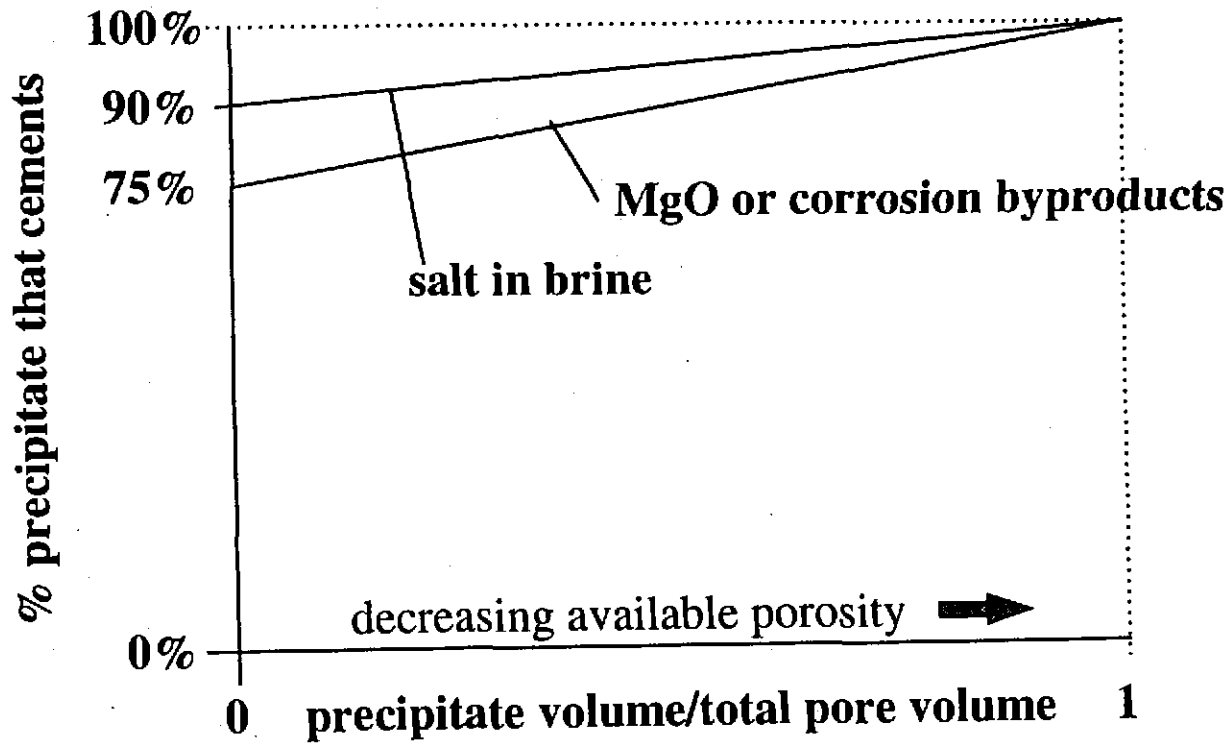

Figure 5-5 Initial Particle Size Population - 5. Plastics/Rubber



Note: precipitates either form particulates or cement

Figure 5-6 Precipitation

Information Only

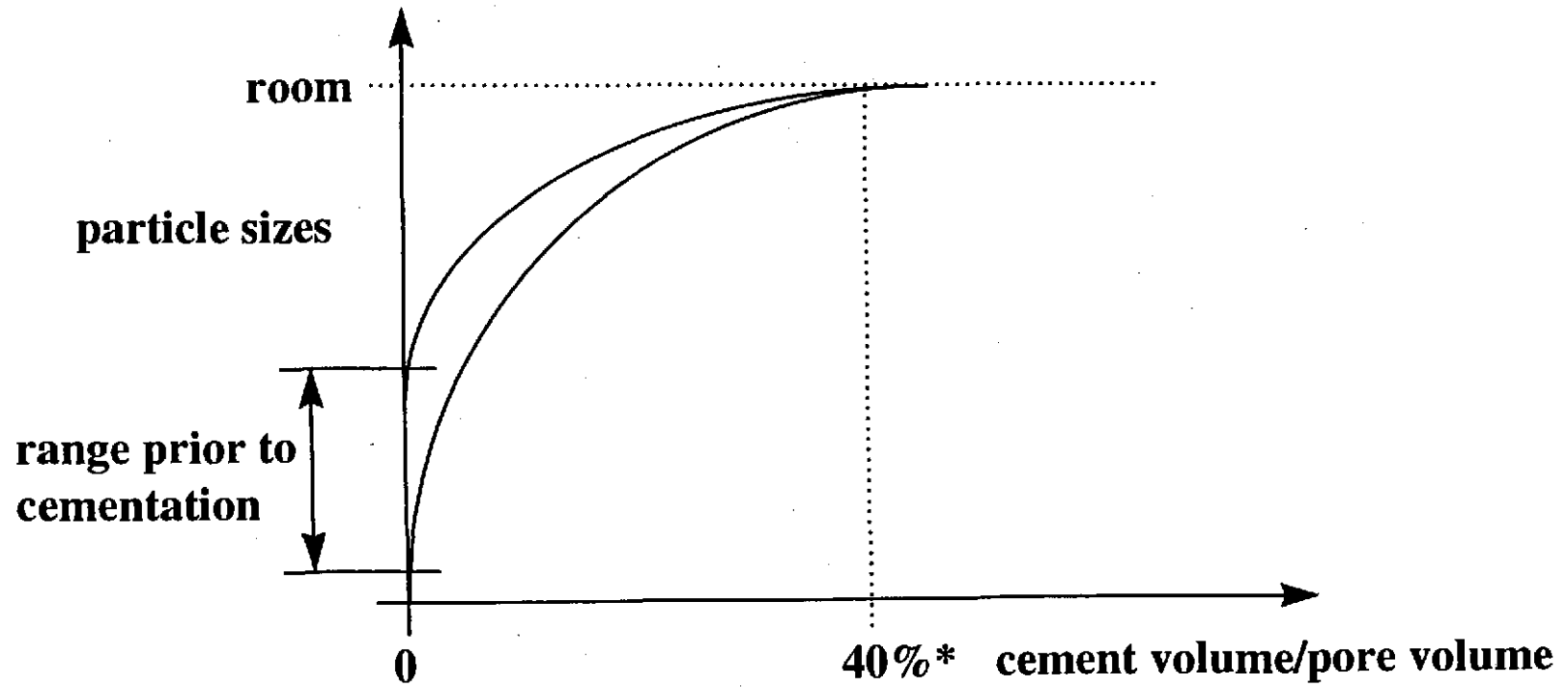

*Note: example for pre-cementation porosity of 25%



Figure 5-7 Cementation



6. Results

The model presented in Section 4 was implemented with the experts' parameter assessments presented in Section 5 in order to illustrate how to estimate waste particle diameters at the time of inadvertent human intrusion as a function of predicted repository conditions. In this section, these results are presented in a format compatible with PA, as discussed in Section 2.

6.1 Distribution of Particle Sizes

The distribution of particle sizes at a random location at the time and scale of an inadvertent human intrusion can be developed as a function of the estimated extent of processes which have occurred up to that time, as predicted by PA. This result is expressed in the form of a model, as discussed in Section 4 and presented in Appendix B. Hence, there is no unique particle size distribution (except for the initial conditions at the end of the 100-year active institutional controls period), but instead it must be assessed in conjunction with PA.

A simple hypothetical example has been developed to illustrate how the model could be used and the types of results that might be obtained, depending on the repository conditions predicted by PA. These results are shown in Figure 6-1.

In addition to the assessed initial amounts and particle size distributions for the various waste groups, as well as the characteristics of their degradation byproducts and dissolved constituents at the end of the 100-year active institutional control period (see Section 5), these results are based on the following hypothetical inputs from PA for the specified time of intrusion:

- *corrosion* of iron and aluminum base metals is 50% complete (i.e., 50% of the material remains) and has removed a depth of 10 microns on average from every surface (i.e., a change of 10 microns in the radius of an equivalent spherical particle);
- *biodegradation* of cellulose and solidified inorganics is 50% complete (i.e., 50% of the material remains) and has removed a depth of 10 microns on average from every surface (i.e., a change of 10 microns in the radius of an equivalent spherical particle);
- *biodegradation* of rubber and plastics is 50% complete (i.e., 50% of the material remains) and has removed a depth of 10 microns on average from every surface (i.e., a change of 10 microns in the radius of an equivalent spherical particle);
- *dissolution* of MgO is 50% complete (i.e., 50% of the material remains) and has removed a depth of 10 microns on average from every surface (i.e., a change of 10 microns in the radius of an equivalent spherical particle);
- *porosity* of the waste which is available for cementation is 20%;
- *precipitation* of dissolved salt from the brine (due to corrosion and MgO dissolution), either as free particulates or as cementing agents, comprises 20% of the waste; and
- *encapsulation* of waste by creeping salt comprises 10% of the waste volume.

It must be emphasized that these repository conditions are strictly hypothetical, and are not necessarily consistent with any actual PA results.

As shown in Figure 6-1, the initial particle size distribution shifts to the left (i.e., smaller particles) due to reduction processes (corrosion, biodegradation, and dissolution). This modified distribution then shifts back to the right, with even larger particles than before reduction, as cementation (due to precipitation of corrosion products, dissolved MgO and salt from brine) is considered. The distribution shifts even further to the right as encapsulation (due to salt intrusion by continuing plastic flow) is considered. For example, about 25% of the particles are predicted to be larger than 1cubic centimeter (cc) before reduction, cementation, and encapsulation are considered. In this hypothetical example, this decreases to about 19% as the reduction processes are considered, but increases to more than 99% as cementation and encapsulation are considered. The cumulative frequency for any other particle size, or the particle size for any other cumulative frequency (i.e., percentile value), for the hypothetical repository conditions can be derived by interpolation from Figure 6-1.

It must be also emphasized that the particle size distributions are a function of the repository conditions at the time of inadvertent intrusion. Although the initial results at the end of the 100-year active institutional controls period will be the same as shown in Figure 6-1, the results after reduction, cementation, and/or encapsulation may be significantly different than the hypothetical example shown here.

The uncertainty in future repository conditions can be propagated through the particle size distribution model in various ways to determine the uncertainty in particle size distributions. However, such implementation is outside the scope of this elicitation.

6.2 Discussion

6.2.1 Assessment

This study addresses the distribution of waste particle sizes at the time of inadvertent intrusion, sometime during the 10,000 years following the end of the 100-year active institutional controls period. Because such distributions cannot be determined absolutely, it is expressed in terms of a probability distribution (or relative likelihood) of particle size populations. This probability distribution has been determined by assessing the value of various "parameters" (e.g., extent of a process), and then implementing those parameter assessments in a model, which incorporates specific assumptions. There are various types of parameters, including:

- *Boolean single value* - one of two possibilities, such as whether biodegradation will occur;
- *Discrete single value* - one of a finite set of possibilities, such as which material will be intersected by a borehole;
- *Continuous single value* - one of an infinite set of possibilities, such as the extent of corrosion; and
- *Population of single values* - one combination of a finite (for discrete variables) or infinite (for continuous variables) set of possible combinations, such as the sizes of all particles potentially affected by a borehole.

However, because of the nature of the parameters, they cannot be known with certainty and the information that is available does not allow for their statistical derivation. Instead, a subjective assessment based on the judgment of a group of experts, consistent with available information, is necessary. The assessments involve estimates of the possible values and their relative likelihood (probability distributions) for each single value parameter (including Boolean, discrete, and continuous single value variables, and the statistics such as the mean of populations of discrete or continuous single value variables). Therefore, the resulting probability distribution for the population of particle sizes is necessarily based on:

- specific models and assumptions for determining the particle size distribution, as a function of specific parameters;
- currently available information regarding those parameters; and
- the opinions of a specific group of experts regarding the possible values of various parameters, based on that information.

6.2.2 Reliability

Appropriately, the questions can be asked, how "reliable" are these results, what other results would be possible, and how likely are they? Different results could conceivably occur due to:

- changes in the opinions of the group of experts regarding their interpretation of the available information, which could lead to changes in the assessment of model input parameters;
- the use of a different group of experts, who might have different opinions regarding their interpretation of the available information, and thus would have different assessments of model input parameters;
- the use of different models and assumptions for implementing the input parameter assessments; and
- additional information, which would affect the group's assessment of model input parameters.

These issues relate to group internal and external consistency, model uncertainty, and additional information, respectively, and are discussed separately below.

6.2.2.1 Internal Consistency

The elicitation process was intended to ensure that the specific group of experts was as accurate as possible in expressing its collective assessment of the various model input parameters, consistent with the available information. Hence, it is unlikely that, given the same information, this group would change its opinion significantly regarding their probability distributions for the input parameters, and thereby change the resultant probability distribution for particle size population. Although conceivably this could be quantified by repeating the group's assessments without referring back to their previous assessments, this would be very costly (essentially adding 100% of the original costs of elicitation for each repetition) and would not be expected to show much difference, given the initial level of care.

M

6.2.2.2 External Consistency

Similarly, the group of experts is relatively large and was selected based on their qualifications in the various areas of interest and on their lack of biases, as well as their availability. Hence, the group can be considered a representative sample of the unbiased technical community. The inherent variability in opinions among individual members of the group was averaged out, to some extent, through consensus building. Because of its size, qualifications and lack of bias, it is unlikely that, given the same information, another representative group (or the technical community as a whole) would have significantly different collective opinions regarding their probability distributions for the input parameters and thus, a different resultant probability distribution for particle size populations. Although conceivably, this could be quantified by having other groups independently assess the same parameters, based on the same information but without referring back to the original group's assessments, this would be very costly (essentially adding 100% of the original costs of elicitation for each repetition) and would not be expected to show much difference, given the group's representative characteristics. It should be noted, however, that individuals within the technical community might have significantly different opinions, especially if they are biased or have different qualifications, and they would thus have a very different resultant probability distribution for particle size populations. It can be argued that such "outliers" are not representative of the entire technical community and that they would be averaged out in a collective assessment, in a similar way as was done within the group (i.e., through consensus building). Although the variability in individual's opinions could be quantified by having various individuals independently assess the same parameters, again based on the same information but without referring back to the original group's assessments, this would be relatively costly (essentially adding 10 to 20% of the original costs of elicitation for each individual assessment) and would not be expected to be very useful, because it ignores the effectiveness of consensus building.

6.2.2.3 Model Uncertainty

Although reasonable models and assumptions were used to implement the input parameter assessments, other models and assumptions could have been used. For example, specific distribution forms and their descriptive parameters (e.g., parameters of the power law) were used in some cases to fit the expert's assessments. In other cases, specific assumptions were used (e.g., independence of processes and materials). The expert panel agreed that these were reasonable assumptions. Although conceivably, all other potential models and assumptions could be identified and their validity evaluated, and the associated probability distribution for particle size populations determined and qualified by that validity, this would be relatively costly (essentially adding 100% of the original analysis costs for each alternative model/assumption) and would not be expected to be very useful unless the current model/assumptions result in particle size populations that lead to unacceptably high releases, which in turn, lead to unnecessarily expensive decisions.

6.2.2.4 Additional Information

Currently available information has necessarily been used by the group of experts in their assessments of the model input parameters. Additional information might reduce the uncertainty in the assessment of any single value parameter (e.g., the effect of one process on one material), although the variability among members of a population (e.g., particle size populations throughout the repository at a particular time and scale) would remain. Such changes in the model input parameter assessments would clearly affect the resultant probability distribution for particle size populations. In fact, if "perfect" information could be obtained (which is impossible), then the uncertainties in the single value input parameter

assessments would be reduced to zero (they would be known), and the probability distribution for particle size populations would simply be a function of the random-chance factors (e.g., where the intrusion occurs and, therefore, which subgroup of the population will be involved). For example, the relative likelihood of what the assessed probability distribution for particle size populations would be after perfect information on the effects of each process on each material has been obtained (using the same models and assumptions) would be given by: 1) the probability distribution for the extent of each process as a function of time (from PA); and 2) the probability distribution for the initial population of particle sizes for each material. The uncertainty in the updated probability distribution for particle size populations given perfect information, gives the bounds if less than perfect information is obtained. The process of revising probabilistic assessments based on new information is called "Bayesian updating," and is predicated on obtaining additional information about the parameter. However, if no additional relevant information is obtained, then the assessed probability distribution of particle size populations does not change. It is unlikely in this case that substantial additional information (much less "perfect" information) on this topic can be obtained in the reasonable future, so that the model input parameters assessments, and thus the assessed probability distribution of particle size populations, will not change significantly. It should be noted that, in any case, the current uncertainty is relatively small compared to variability, which leads to relatively small uncertainty in the updated probability distribution of particle size populations, given any additional information.

6.2.3 Conclusions

The various potential causes for significant changes in the assessed probability distribution of particle size populations include: different models or assumptions used in decomposing the issue, as a function of specific parameters; internal and external inconsistencies in subjective assessments of model input parameters based on available information; and additional information related to model input parameters. Each of these potential causes have been evaluated for this study, and found to be either inoperative or mitigated (e.g., through careful procedures). Hence, it is believed that the model for estimating particle size populations developed in this study is reasonable and defensible, and that significantly different assessments will not be determined in the foreseeable future.



**Figure 6-1 Example Results for Distribution of Waste Particle Sizes
for a Hypothetical Set of Predicted Repository Conditions at the Time of Inadvertent Intrusion**

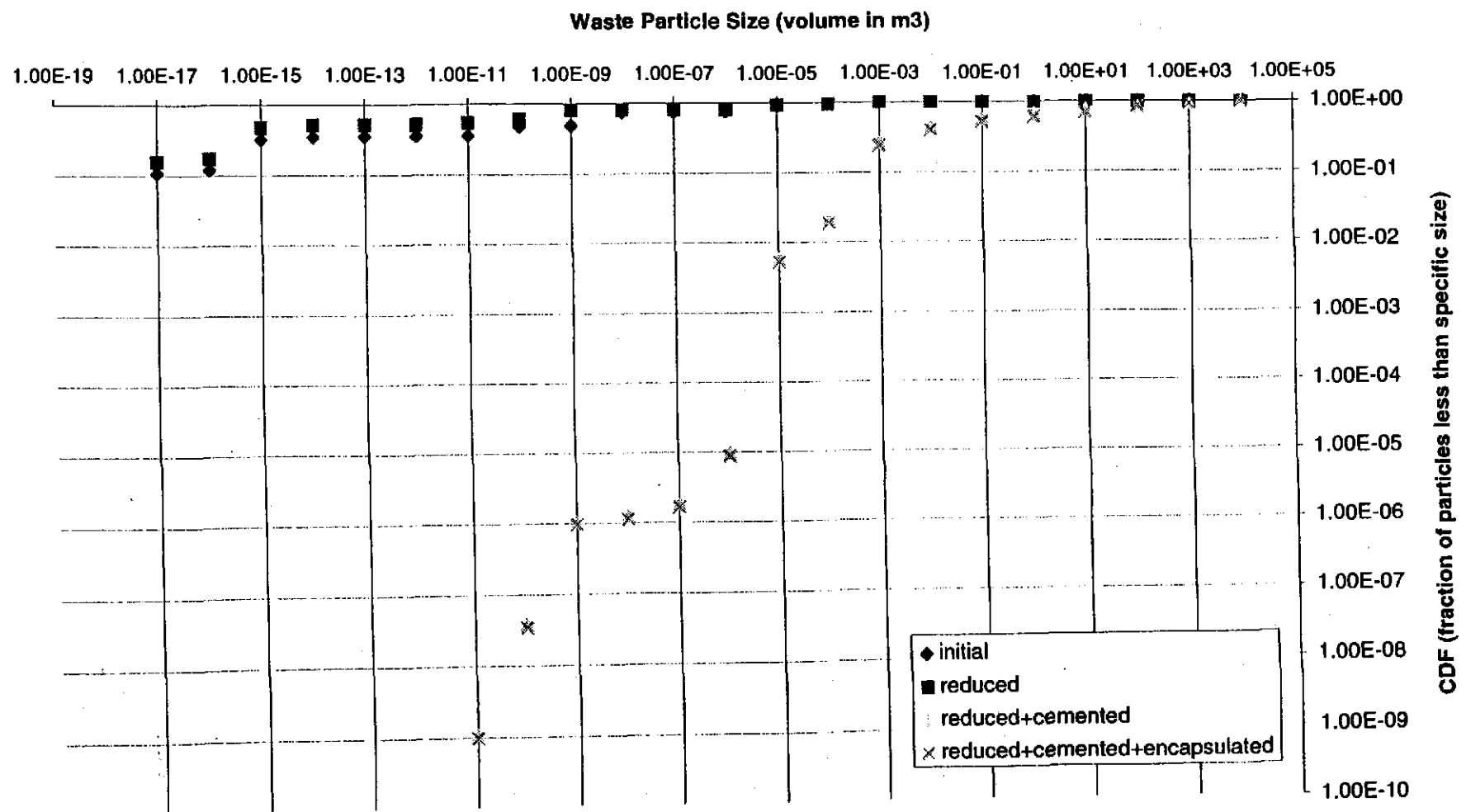

M

7. Conclusions

Conclusions and any potential limitations regarding the process and results of the expert elicitation on waste particle diameters at the time of inadvertent human intrusion, as described in previous sections of this report, include the following:

- A defensible conditional probability distribution for the frequency of waste particle sizes at the time of inadvertent human intrusion (subsequent to the 100-year active institutional controls period) has been developed in the form of a model, which relies on PA for input on future repository conditions and which in turn can be used by PA in predicting waste release scenarios. However, the implementation of the particle size distribution model and the subsequent application of the results of the model in PA is outside the scope of this expert elicitation.
- Currently, only the average (large scale) initial waste amount and repository conditions have been considered. However, there may be significant variability in these input parameters, and then in particle size distribution, among locations at the relatively small scale of interest. Such variability has been considered qualitatively, but could be accommodated in the current particle size distribution model, if needed.
- The radioactivity associated with various particle sizes is outside the scope of this expert elicitation and it has not been assessed in this elicitation. However, although it is a complex issue, it should be noted that a significant portion of the particles (e.g., related to backfill and salt fragments) are non-radioactive.



9. Review and Approval

This report was prepared by the elicitor and reviewed and approved by the six subject-matter experts, as indicated their respective signatures below.



Paul Drez, Expert Panel Member



Michael Gross, Expert Panel Member



Patrick Domenico, Expert Panel Member



Paul LaPointe, Expert Panel Member



David Grandstaff, Expert Panel Member



Robert Mutaw, Expert Panel Member

Best Copy Available



ATTACHMENT I



UNITED STATES ENVIRONMENTAL PROTECTION AGENCY
WASHINGTON, D.C. 20460

MAR 19 1997

OFFICE OF
AIR AND RADIATION

Honorable Alvin Alm
Assistant Secretary for
Environmental Management
U.S. Department of Energy
1000 Independence Ave., SW
Washington, DC 20585



Dear Mr. Alm:

The U.S. Environmental Protection Agency (EPA) received the U.S. Department of Energy's (DOE) Compliance Certification Application (CCA) for the Waste Isolation Pilot Plant (WIPP) on October 29, 1996. The Agency immediately commenced its review pursuant to Section 8(d)(1) of the WIPP Land Withdrawal Act, as amended, to evaluate whether the CCA demonstrates and documents WIPP's compliance with EPA's radioactive waste disposal regulations at subparts B and C of 40 C.F.R. Part 191.

On December 19, 1996, Mary Nichols, Assistant Administrator for the Office of Air and Radiation, sent you a letter identifying certain aspects of the CCA that my staff had preliminarily determined to require additional support or documentation. The purpose of that letter was to provide DOE, as early as possible, with a preliminary assessment of EPA's concerns regarding the CCA. Since we sent that letter, we have had the opportunity to: (1) conduct a more detailed review of the CCA; (2) preliminarily consider numerous public comments received on the CCA during the public comment period; and (3) evaluate DOE's responses to the letter. Based upon careful evaluation of each of these factors, we have developed lists of issues that need to be addressed by DOE in order for EPA to render a compliance certification decision (see Enclosures 1-6). This letter is based on a review of all materials received by EPA by March 12th. Since we continue to receive information from DOE on a regular basis, some of the information received since March 12th may address certain points raised in the enclosures. We

will expeditiously review these materials, as well as materials received in the future.

The first issue is the adequacy of certain conceptual models. As you are aware, the Spallings Model predicts the amount of solid material released during a drilling event -- an important release scenario. The Spallings Model has been found inadequate by DOE's independent peer review panel. Also, the Chemical Conditions Model, which determines the dissolution of radionuclides in brine found around WIPP, has been deemed inadequate by the same DOE peer review panel. We have been informed by your staff that the peer review panel will be reconvened March 31 to April 4, 1997, to re-evaluate these models. The results of these peer reviews are critical to the Agency's evaluation of the CCA. We request that DOE provide us with the peer review reports and DOE's assessment of the status of the conceptual models. This will enable us to determine the impact on our review of the CCA.

The second area of concern is the derivation of important input parameters, and their associated values, for the performance assessment. This concern is significant because parameters are used as inputs to the computer codes that calculate potential releases from the WIPP. Of the approximately 1,600 input parameters reviewed by EPA, 58 parameters that could have a significant impact on the results of the performance assessment are of concern. I have divided these 58 parameters into three different categories, each of which is listed in a separate enclosure.

The first set of parameters is those for which we have been unable to find supporting data (see Enclosure 2). My staff has been working continuously since November to establish the traceability of the parameter and data record packages that support the input parameter values used in the performance assessment. The Records Center has greatly improved since November. We encourage the Department to continue with these improvements to facilitate retrievability of records. To date, 13 key input parameters are either not supported by experimental or field data, or the data trail is untraceable. The Compliance Criteria, at 40 C.F.R. §194.26(a), clearly indicate that input parameters should be based on actual experimental data. To the extent that certain input parameter values cannot be obtained

3

through data collection or experimentation. DOE may derive such values using "expert judgment." The Compliance Criteria set forth explicit requirements for the proper conduct of elicitation of such expert judgment. Thus, in accordance with the Compliance Criteria, DOE must provide the following support for the critical input parameters that appear to be unsupported by actual data: (1) documentation of actual data collection and/or results of experimentation, or (2) demonstration that EPA's expert judgment procedures were followed in selecting the parameter values.

The second set of five input parameters are those for which EPA has reviewed the supporting information and finds that the information in the record supports a value or range of values different from those selected by DOE (see Enclosure 3). EPA suggests that new values or ranges be selected for these parameters. My staff will be available to meet with DOE to explain these suggested changes.

The final set of 40 input parameters are those for which EPA has reviewed the supporting data and has questions about the value(s) selected (see Enclosure 4). My staff will be available to meet with DOE staff to review the supporting documentation for each of these parameters to see if changes to the value or range selected for each parameter are needed.

The third area of concern relates to specific scenarios that were eliminated from the CCA's performance assessment calculations. As you know, conceptual models represent our understanding of WIPP and include different types of scenarios, such as human activities (e.g., drilling) and geologic processes (e.g., earthquakes), that could occur over the regulatory time frame. EPA has concluded, as have numerous public commenters, that the CCA does not contain adequate justification for eliminating consideration of the occurrence of certain fluid injection scenarios at WIPP. Therefore, EPA requires either additional substantiation to support the elimination of fluid injection scenarios from performance assessment calculations, or revision of the performance assessment to include appropriate fluid injection scenarios.

The last item of concern relates to the final results of the performance assessment calculations. Since the performance assessment represents how WIPP is expected to perform in the future, it is critical that site characteristics, conceptual models, computer codes, and input parameters be as representative of the disposal system as possible. EPA believes that final resolution of the three issues identified above may result in different performance assessment input values, as well as revisions to some of the models. Further, EPA is aware that some models have already been changed by DOE and its contractors. Accordingly, DOE will probably need to rerun the performance assessment to demonstrate that the WIPP complies with the disposal criteria using the revised models, input parameters and scenarios. If DOE decides not to rerun the performance assessment, the Department will have to demonstrate why the combined effect of all the changes is not significant enough to require new performance assessment computer runs. An individual impact analysis of each change that does not take into account the synergistic and holistic effects of all of the changes will not be sufficient. This new performance assessment or demonstration will enable us to complete our review of the CCA.

M

The above requests, as well as a complete listing of other Agency concerns, are explained in detail in Enclosures 1-6 to this letter. Enclosures 5 and 6 list findings from recent quality assurance and peer review audits conducted to verify conformance with the Compliance Criteria at 40 C.F.R. §194.22(a)(1) and §194.27(b), respectively. The issues described in this letter and enclosures include EPA's outstanding concerns with the CCA. In order to facilitate EPA's decision-making process, please send me a letter describing how, and when, the Department will resolve these concerns.

M

Thank you for your continued cooperation during our review process. Should you have questions regarding this request, please call me at (202) 233-9320.

Sincerely,

E. Ramona Trovato

E. Ramona Trovato, Director
Office of Radiation and Indoor Air

Enclosures

cc: Mary D. Nichols (EPA)
Tom Grumbly (DOE/MQ)
George Diala (DOE/CAO)

Best Copy Available

Enclosure 1

WIPP Compliance Certification Application Technical Issues Requiring Additional Information Prior to EPA Rendering a Certification Decision

Content of Compliance Certification Applications

194.14(a)(2)

Section 194.14(a)(2) states that the description of the disposal system shall include a description of the geology, geophysics, hydrogeology, hydrology, and geochemistry of the disposal system and its vicinity and how these are expected to change and interact over the regulatory time frame.

The CCA identifies a new conceptualization of the origin of the hydrogeochemical facies in the Culebra. The explanation of the relationship between the hydrochemical facies and the groundwater basin modeling is not adequate. Section 2.2.1.4.1.2 briefly mentions a potential relationship but does not provide support for the relationship.

DOE needs to provide a discussion of the origin of the hydrochemical facies that incorporates the modeled Culebra paleoflow directions with geochemical principles.

Data Quality Characteristics

194.22(e)

Section 194.22(e) requires that the compliance application describe, to the extent practicable, how data used to support compliance have been assessed for the five referenced data quality characteristics: accuracy, precision, representativeness, completeness and comparability.

Section 5.3.21.1 of the CCA states that " ...it is not practical to apply data quality characteristics to most scientific investigations used to support a performance assessment in which there is uncertainty in the conceptual models and the resultant ranges of parameters."

While some information that supports this statement was provided in the CCA, EPA requires additional documentation from DOE that supports the CCA arguments and uses specific measured data points as examples.

Models and Computer Codes

194.23(a)(3)(I)

Section 194.23(a)(3)(I) states that any compliance application shall include documentation that conceptual models and scenarios reasonably represent possible future states of the disposal system.

~~CONFIDENTIAL - SECURITY INFORMATION~~

Best Copy Available

It is EPA's understanding that after an initial E2 drilling intrusion, subsequent E2 drilling intrusions do not produce releases via spillings or direct brine release. It is not clear whether this is a modeling outcome or an assumption.

DOE needs to provide a description of the implementation of the E2 scenario that addresses releases when another E2 event occurs.

194.23(a)(3)(iv)

Section 194.23(a)(3)(iv) states that computer models must accurately implement the numerical models; i.e., computer codes are free of coding errors and produce stable solutions.

(1) Testing of the functional requirements for SECOTP2D is not documented in the CCA's validation documents. The information presented in the Analysis Plan (provided in December 1996) addresses this comment from a completeness standpoint; however, the testing of the SECOTP2D is not technically adequate.

DOE needs to test SECOTP2D with a heterogeneous transmissivity field.

(2) There appears to be a mass balance problem in SECOTP2D that could cause the computer code to produce calculations with errors and thus inaccurately implement the numerical models.

DOE needs to provide an analysis of the mass balance in SECOTP2D and its effects on calculations of radionuclide transport in the Culabra.

(3) Potential errors have been found in the computer codes.

DOE needs to identify errors that have been found in the computer codes since the PA calculations were run for the 10/29/96 CCA submission. DOE needs to describe the impact of those errors on the results of PA.

(4) While the type of testing for the SECOTD code appears to be appropriate, the most relevant tests (listed in Record 25, WFO 43367) are only briefly described, and test results are not presented.

The tests mentioned in Record 25 need to be fully described and the results provided.

194.23(e)(2)

Section 194.23(e)(2) requires that the CCA include detailed instructions for executing the computer codes, including hardware and software requirements, input and output formats, listings of input and output files from a sample computer run, etc.

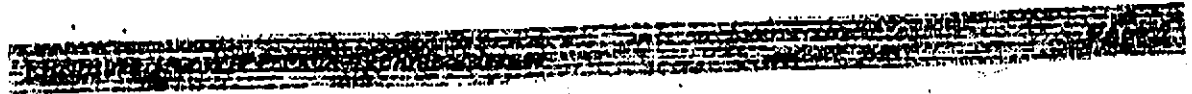

NUTS Validation Document, page 1205: EPA commented in the December 1996 letter that there is no obvious physical reason for oscillations in the concentration profile and there are concerns about the adequacy of the testing. DOE responded that the "apparent oscillations" are actually concentration accumulations due to the velocity field and coarse grid that was used. DOE also stated that no attempt was made to actually solve the problem described in the test, but instead, the purpose was to determine whether NUTS could track the results computed by an independent technique (i.e., MT3D) given the velocity field. This may be true, although it raises two issues: (1) Since MT3D is known to have problems producing accurate solutions, an essentially perfect match of the NUTS results to these inaccuracies does not produce confidence that the NUTS code is providing accurate solutions; and (2) the fact that the same degree of grid coarseness leads to exactly the same level of inaccuracy in both codes is unusual behavior for two independently formulated codes.

DOE should use the computer code SWIFT to benchmark NUTS for the same problem, with the exception that the grid be made fine enough to provide an accurate solution.

194.23(e)(4)

Section 194.23(c)(4) states that detailed descriptions of data collection procedures, sources of data, data reduction and analysis, and code input parameter development must be documented in the CCA.

(1) Concerns regarding anhydrite marker beds still need to be addressed. Specifically, the information on the incorporation of the anhydrite behavior is very general and does not provide the detailed information necessary to reproduce DOE's results regarding the incorporation of permeability and porosity.

DOE needs to provide information that explains the methodology by which the permeability versus pressure curves and porosity versus pressure curves were developed. DOE needs to explain the permeability and porosity curves generated by Mike Lord (attached to the February 26 response as the 1/29/96 memo to Margaret Chu and the 1/24/96 memo from Kurt Larson to Mike Lord and others).

(2) Concerns regarding a low transmissivity feature still remain. A low transmissivity region appears consistently in the calibrated transmissivity fields in the northeastern portion of the site where there are little data. Care must be taken with model interpretations in regions where there are little data to corroborate the interpretation. Low transmissivity produces long travel times and could produce an overly optimistic PA.

Information provided by M. LaVenne at a DOE meeting on 17 and 18 September 1996 at Sandia originally indicated that the low transmissivity region is due to a single very low transmissivity data point at P-18. From the histogram of Culebra transmissivity data, the

P-18 data point could be argued to be a statistical outlier. Given the large variation of transmissivity data over the wider region, the P-18 data point could also be valid. But the geostatistical methods in GRASP_INV should not allow the data point at P-18 to produce low transmissivity in the northeastern portion of the site that is far separated from P-18.

The DOE response to EPA's request of December 19, 1996 stated that there are no independent data to confirm the P-18 data point. But it is stated that the P-18 data point is consistent with the geological conceptual model. Further, it is stated that the P-18 data point has a minor effect because of the geostatistical methods used in GRASP_INV.

While the above DOE response is reasonable, the original question still remains as to why there is a low transmissivity feature in the eastern portion of the site where there are little data to confirm the feature.

DOE needs to provide the transmissivity field that results from kriging the transmissivity data and which does not show the low transmissivity region in the northeastern part. DOE needs to provide several typical transmissivity fields calibrated to steady-state head data that show the appearance of the low transmissivity feature in the northeastern part of the site. These plots need to be accompanied with an explanation as to the reasons why the calibration causes this low transmissivity feature in the northeastern part of the site.

(3) "Legacy" parameters were developed and used in the 1992 PA calculation and in the CCA PA calculations without alteration. Current parameter packages simply reference "Legacy" parameters without explaining how they are developed or providing traceability to source documents.

DOE needs to document the development of "Legacy" parameters to show traceability.

Waste Characterization

194.24(a)

Section 194.24 requires the CCA to include a description of the chemical, radiological, and physical composition of all existing waste (and, to the extent practicable, to-be generated waste) proposed for disposal in the WIPP.

1) The BIR indicates that the Department has collected more recent information on the waste inventory of the generator sites, in particular, information were collected during the January 1996 data call.

If the Department would like this information considered as part of the application, then it should provide that to the Agency. Otherwise, EPA will assume that the waste inventory

information submitted with the October, 29, 1996 application is that on which we will base our certification decision.



194.24(b)

Section 194.24(b) requires the CCA to include a complete discussion of all waste characteristics that influence disposal performance, including but not limited to solubility, formation of colloids, suspensions, gas generation, shear strength, compatibility, and other waste-related input to model parameters.

1) Adsorption of actinides by immobile mineral surfaces or metal corrosion products can retard the migration of actinides relative to the flow of brine through the repository. Adsorption of actinides onto colloids can enhance actinide migration. The CCA apparently does not account for the adsorption of actinides onto colloids in determining the releases during cuttings/cavings.

The Department needs to provide a description of how adsorption of actinides was accounted for in releases of cuttings/cavings. If adsorption not taken into account, the Department needs to show how this would lead to a conservative release estimate.

2) The effects of organic complexants on actinide solid solubilities within a brine system has not been well documented through experimental or modeling studies.

The Department needs to provide more detail discussion on the use of HYDRAQL code, especially in respect to quantity of organic complexants used in the calculation.

194.24(c)(1)

Section 194.24(c)(1) requires DOE to demonstrate that for total inventory of waste proposed for disposal, WIPP complies with the numeric requirements of section 194.34 for the upper and lower waste limits, including their associated uncertainties.

It is not evident in the CCA how the Department is treating the associated uncertainties for the upper and lower limit for each waste component.

The Department needs to identify the method by which the uncertainties associated with the upper and lower limits for each waste component are being incorporated into the results of the performance assessment.

194.24(c)(3)

Section 194.24(c)(3) requires the Department to provide information which demonstrates the use of process knowledge to quantify waste components.

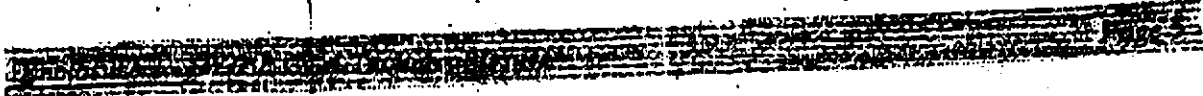

Acceptable knowledge plays a key role in identifying the origin or generation of TRU wastes. This information is used to help inform the non-destructive assay (NDA) process in the selection of the appropriate correction or calibration factors. The operational history of a site indicates many important details of the waste matrix. Each TRU generator site considers acceptable knowledge in choosing measurement equipment, designing analytical protocols and establishing the types and ranges of correction and/or calibration factors for NDA measurement systems. However, the CCA is not clear on what the protocol is for determining this information when no acceptable knowledge information is available.

The Department needs to provide the protocol for determining the NDA measurement equipment, designing analytical protocols and establishing the types and ranges of correction and/or calibration factors for NDA measurement systems when no acceptable knowledge information is available.

194.24(c)(4)

Section 194.24(c)(4) requires the CCA to provide information which demonstrates that a system of controls has been and will continue to be implemented to confirm that the total amount of each waste component that will be emplaced in the disposal system will not exceed the upper limit or fall below the lower limit.

The CCA discusses the WIPP Waste Information System (WWIS) which the Department proposes to use for the purpose of tracking the quantity of waste emplaced in the WIPP. It is not clear what information will be collected regarding the location of drums in the repository. In addition, the WWIS Software Design Description contains the internal details of each design entry including a description of the data elements associated with each entity. Although the WWIS lists the data elements, it is not clear which data elements are active or inactive and are functioning as placeholders.

EPA will soon be conducting an audit of the WWIS system. The Department should be prepared to address the above issues during the conduct of that audit.

194.24(d)

Section 194.24(d) requires the Department to provide a waste loading scheme, or else the performance assessments shall assume random placement of waste in the disposal system.

The CCA assumed that the containers of waste would be emplaced randomly for the 569 waste streams tracked in the TWBIR. The CCA also assumes that the sampling of 10,000 fixtures was large enough that the relatively low probability combination of three of the waste streams with higher activity loading occurring in a single drilling event was captured in the CCDFs. However, the assumption that containers will be randomly placed in the WIPP does not take into account likely "real world" scenarios where a specific generator sends a large shipment of a particular

waste stream at one particular time (e.g. RF-Residues from Rocky Flats which is estimated to represent 15 percent of the total curies employed in the WIPP at 2133).

The Department needs to address how it is planning to achieve random loading of waste drums at WIPP. If the Department cannot achieve random loading they need to analyze the effect of non-random loading.

Scope of Performance Assessments

194.32(a)

Section 194.32(a) states that performance assessments shall consider natural processes and events, mining, deep drilling, and shallow drilling that may affect the disposal system during the regulatory time frame.

The CCA does not provide adequate information as to the behavior of short-term brine flow to the surface if a brine pocket is hit.

DOE needs to document the modeling results that support the current approach, which assumes that brine flow to the surface from hitting a brine pocket does not result in releases.

194.32(e)

Section 194.32(e) specifically requires that the PA include an analysis of the effects on the disposal system of any activities that occur in the vicinity of the disposal system prior to disposal and are expected to occur in the vicinity of the disposal system soon after disposal. These activities include boreholes and leases that may be used for fluid injection activities.

The process for solution mining for extraction of brine is distinctly different from other resource extraction techniques. The fluid injection activities used in solution mining can potentially induce alterations, which may not be limited to subsidence and caving, in the host rock (Salado).

DOE needs to consider in the PA existing boreholes in which solution mining can reasonably be expected to occur in the near future.

194.32(e)

Section 194.32(e) states that compliance application(s) shall include information which: (1) identifies all potential processes, events or sequences and combinations of processes and events that may occur during the regulatory time frame and may affect the disposal system; (2) identifies the processes, events or sequences and combinations of processes and events included in performance assessments; and (3) Documents why any processes, events or sequences and combinations of processes and events identified pursuant to paragraph (e)(1) of this section were not included in performance assessment results provided in any compliance application.

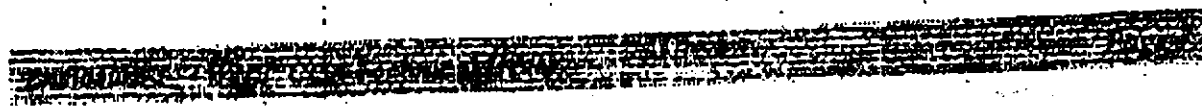

M

(1) The Stoelzel and O'Brien features, events and processes (FEP) analysis (Reference 611) provides information on how fluid injection may effect the disposal system. This approach does not appropriately model this event.

DOE needs to:

(a) Use a 150-year period as the period of simulation.

(b) Identify the extent to which the initial conditions (i.e., conditions before an intrusion event) of the repository could change with the longer period of fluid injection.

(c) Analyze the effects of a human intrusion event subsequent to fluid reaching the repository via a fluid injection event.

(d) Increase the transmissivity of Bell Canyon to allow higher volumes of brine to be injected.

(e) Reduce, by one-half, the DRZ volume.

(f) Estimate the frequency of fluid injection wells that have failed or appear to have failed.

(g) Substantiate why a two-dimensional cross-sectional modeling approach is appropriate for this analysis.

(2) DOE has not analyzed (screened) the potential effects of solution mining of halite in the CCA. Section 194.32(e) requires that performance assessments include an analysis of the effects on the disposal system of such activities in its vicinity prior to disposal or that can reasonably be expected soon after disposal.

DOE needs to provide an analysis of the effects of solution mining for halite. Since the mining of the halite is associated with the production of oil, the time frame for the modeling study may be limited to the potential life of oil production around WIPP (i.e., 150 years).

M



WIPP Performance Assessment Parameters Lacking Supporting Evidence

No.	ID #	Material ID	Parameter ID	Description
1	3245	BLOWOUT	CEMENT	Waste cementation strength
2	3246	BLOWOUT	PARTDIA	Waste particle diameter in Castles Model for direct brine releases
3	198	DRZ_1	PRMX_LOG	Log of intrinsic permeability, X-direction; disturbed rock zone; time period 0 to 1000 yrs
4	2177	S_MB_139	DPHMAX	Incremental increase in porosity relative to intact conditions in the Salado Member Bed 139
5	2180	S_MB_139	PF_DELTA	Incremental pressure for full fracture development
6	586	S_MB_139	PI_DELTA	Pressure initiation pressure increment
7	2178	S_MB_139	KMAXLOG	Log of max permeability in altered anhydrite flow model
8	3194	DII_OPEN	PRMX_LOG	Log of intrinsic permeability x - direction; borehole unrestricted
9	2198	S_ANH_AB	DPHMAX	Incremental increase in porosity relative to intact conditions in the Salado anhydrite beds A and B
10	214	EXP_ARBA	PRMX_LOG	Log of intrinsic permeability, X-direction, experimental area
11	3473	BLOWOUT	THICK_CAST	Thickness of the Castile formation, direct brine releases
12	3456	BLOWOUT	RE_CAST	External drainage radius for the Castile formation, direct brine releases
13	3194	CASTLER	ORIDFLOW	Index for selecting brine pockets

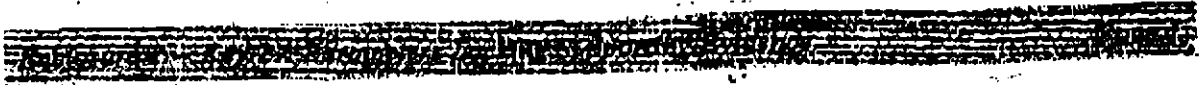

Enclosure 3

WIPP Performance Assessment Parameters Where the Record Supports Values Other Than Those Selected by DOE

No.	ID #	Material ID.	Parameter ID	Description
1	2403	GLOBAL	FBRINE	Probability of Encountering Pressurized Brine
2	2254	BOREHOLE	TAUFAL	Waste Shear Strength
3	3184	BH_BAND	PMMX_LOO	Log of Intrinsic Permeability, z-direction
4	2918	CASTLER	VOLUME	Total Reservoir Volume
5	61	CASTLER	COMP_RCK	Rock Compressibility



Enclosure 4

WIPP Performance Assessment Parameters Not Explicitly Supported
by the Relevant Data/Information

No.	ID#	Material ID	Parameter ID	Description
1	27	BOREHOLE	OMEGA	Drill String Angular Velocity
2	64	CASTLER	POROSITY	Effective Porosity
3	66	CASTLER	PRESSURE	Brine Far-field Pore Pressure
4	259	PAN_REAL	PRALC_LOG	Panel Seal Permeability
5	328	S_ANH_AB	POROSITY	Effective Porosity
6	367	S_MB138	POROSITY	Effective Porosity
7	588	S_MB139	POROSITY	Effective Porosity
8	651	WAS_AREA	ABSRUGHN	Absolute Roughness of Material
9	653	WAS_AREA	COMP_RCK	Bulk Compressibility
10	1993	WAS_AREA	DIRNCCHW	Bulk Density of Iron Containers CH Waste
11	1091	WAS_AREA	DIRNCRHW	Bulk Density of Iron Containers RH Waste
12	3040	WAS_AREA	DIRNCCHW	Average Density of Iron-Based Material in CH Waste
13	2041	WAS_AREA	DCELLENW	Average Density of Cellulosic in CH Waste
14	2374	WAS_AREA	DCELLENW	Average Density of Cellulosic in RH Waste
15	2907	STEEL	CORRMCOR	Inundated Corrosion Rate for Steel w/o CO2 Present
16	3147	CONC_PLG	POROSITY	Effective Porosity
17	3185	CONC_PLG	FRMX_LOG	Log of Intrinsic Permeability, α direction
18	3256	BLOWOUT	FOE	Gravly-Effectiveness Factor
19	3259	BLOWOUT	APOLO	Waste Permeability in CUTTINGS Model
20	3429	PHUMOX	PHUMOX	Proportionality Constant Humic Colloids
21	3471	BLOWOUT	MAXFLOW	Maximum Blowout Flow
22	3472	BLOWOUT	MINFLOW	Minimum Blowout Flow

~~CONFIDENTIAL - SECURITY INFORMATION~~

WIPP Performance Assessment Parameters Not Explicitly Supported
by the Relevant Data/Information

No.	ID #	Material ID	Parameter ID	Description
21	3433	PHUMOXJ	PHUMEDM	Proportionality constant of actinides in Salado Brine with humic colloids, inorganic
24	3470	BLOWOUT	GAS_MIN	Gas Rate Cutoff
25	3317	PU	PROPMMC	Microbial Proportionality Constant
26	3403	SOLMOD6	SOLCDM	U(VI) Solubility Limits - Cattle
27	3406	SOLMOD6	SOLSIM	U(VI) Solubility Limits - Salado
28	3402	SOLMOD3	SOLCDM	Oxidation State +III Model
29	3403	SOLMOD4	SOLCDM	Oxidation State +IV Model
30	3407	SOLMOD4	SOLSIM	Oxidation State +IV Model
31	3404	SOLMOD5	SOLCDM	Oxidation State +V Model
32	3408	SOLMOD5	SOLSIM	Oxidation State +V Model
33	3311	AM	PROPMMC	Microbial Proportionality Constant
34	3482	AM+3	MKD_AM	Matrix Partition Coefficient for Am
35	3480	PU+3	MKD_PU	Matrix Partition Coefficient for Pu
36	3481	PU+4	MKD_PU	Matrix Partition Coefficient for Pu
37	3479	U+4	MKD_U	Matrix Partition Coefficient for U
38	3475	U+6	MKD_U	Matrix Partition Coefficient for U
39	656	WAS_ARBA	GRATMICJ	Gas Production Rate - Microbial Mixed Conditions
40	657	WAS_ARBA	GRATMICI	Gas Production Rate - Microbial Inundated Conditions

M

M

EPA Quality Assurance Audits: Findings & Observations

Since the Department submitted its WIPP Compliance Certification Application on October 29, 1996, EPA has performed quality assurance audits of DOE's Carlsbad Area Office (CAO), Sandia National Laboratory (SNL) and Westinghouse Corporation pursuant to 40 CFR Part 194.22(e). The purpose of these audits was to verify the appropriate execution of the requirements of 40 CFR 194.22(a)(1), which addresses quality assurance for activities associated with the Waste Isolation Pilot Plant (WIPP).

The Agency's findings and observations from the CAO and SNL quality assurance audits are listed below. There were no findings or observations from the audit of the quality assurance program of the Westinghouse Corporation. A finding is a specific nonconformance with an applicable NQA element or the element's implementing procedure. An observation is not a nonconformance, but does require a response.

Findings and Observations From EPA's Quality Assurance Audit of the Carlsbad Area Office

On December 9-13, 1996, EPA performed an audit of DOE's CAO quality assurance program pursuant to 194.22(e). The purpose of the audit was to verify the appropriate execution of the requirements of 40 CFR 194.22(a)(1). The audit team identified four findings of relatively minor and isolated consequences during the audit.

Finding No. 1

NQA-1, Requirement 2 states that the management of those organizations implementing the quality assurance program shall regularly assess the adequacy of that part of the program for which they are responsible and shall assure its effective implementation.

However, CAO's MP 9.1, which implements this NQA requirement, contained no provision for regular assessments. At the time of the audit, MP 9.1 was under revision and was to be changed to address this finding.

Finding No. 2

Team Procedure TP 10.5, Requirements 3.4.2(a) and (c) require documentation of orientation of peer review team members.

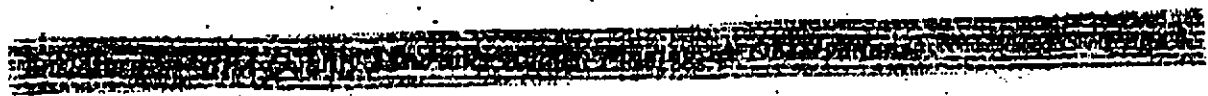

However, documentation was not available to demonstrate orientation training for one of the panel members for Peer Review No. 3.

Finding No. 3

Team Procedure TP 10.5 (Rev. 0), Requirement 3.1.3(a), requires that the peer review selection committee shall be impartial and have no conflict of interest, including financial gain.

However, the chair of the peer review selection committee, which chose the panel for Peer Review No. 3, is the executive vice president of the firm where one of the selected panel members is employed. It was not clear from the information presented during the audit whether the chair of the selection committee may have been in a position in which his own personal interest was conflicted with the independent performance of the Peer Review panel No. 3.

Finding No. 4

The audit team identified some documentation that was missing from the DRR files for TP 10.5 (Rev. 0 and Rev. 1).

Copies of the missing information were found and placed in the DRR files during the audit.

Findings and Observations From EPA's Quality Assurance Audit of Sandia National Lab

On January 13-24, 1997, EPA performed an audit of the Sandia National Laboratory Quality Assurance Program pursuant to 194.22(a). The purpose of the audit was to verify the appropriate execution of the requirements of 40 CFR 194.22(a)(1). The audit team identified six findings and six observations during the audit.

Finding 1

NQA-1, Supplement 1S-1, states "quality achievement is verified by persons or organizations not directly responsible for performing the work." However, QAP 1-1 states "The management is responsible for verifying the quality."

Finding 2

NQA-3, Requirement 2.4, states "Management assessments of the quality assurance program shall be conducted regularly and reported at least annually."

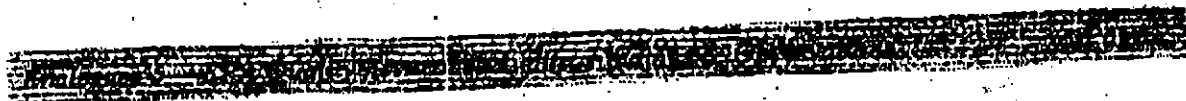

However, the last management assessment was performed in April 1995:

M

Finding 3

Several CAR files requested from the Records Center were found to be incomplete, i.e., referenced documents were not included in the files, or listed on the Record Package Table of Contents.

CAR	Missing Documents
EA96-15-QAF-1	Original log sheet and correction
EA96-15-QAF-5	Attachment documenting sample identification scheme
EA96-26-QAF-1	Corrective Action Request form, initial proposed resolution of CAR (determined to be unacceptable), and revised proposed resolution of CAR (acceptable)
W97-003	Summary memo, including Statement of Impact

Finding 4

Section 4.1, Step 4, of QAP 5-1 requires the use of the format described in Appendix A.

QAP 5-1 does not conform to its own requirements for procedure format.

Finding 5

NQA-3, Supplement 3SW-1 states "All data shall be recorded so that they are clearly identifiable and traceable to test experiment, study, or other source from which they were generated."

However, the supporting documentation for the following parameters analyses do not meet traceability requirements:

Parameter No. Id. 34, Borehole PRMX_LOG is listed as a placeholder parameter. The parameter value listed in Form 464 is not traceable.

Parameter No. Id. 3148, CONC_PLO COMP_RCK, listed two sets of parameter values. There is no traceability documentation provided for the first set of data, which has a parameter value of "0." The second set of data has a parameter value of 1.2E-09, which was listed in Form 464 and is traceable, but has never been used. Instead, the parameter value of 2.64E-09 was used, but this value has never been entered into Form 464.

[REDACTED]

Although 2.64E-09 is the wrong value to use in the analysis, traceability documentation must still be provided with Form 464.

Finding 6

QAP 5-1, Revision 2, Section 4.2, Step 1, Note 1 states that QAPs are allowed to carry ICN changes for up to one year before they are revised and reissued.

QAP 2-4 has two ICNs that exceed the one-year limitation. ICN 01's effective date is 10/27/95 and ICN 02 has an effective date of 11/17/95. QAP 20-3 has an ICN with an effective date of 10/13/95. ICN 01 for QAP 5-1 rescinds the one-year limitation on the incorporation of ICNs through QAP revision. However, this ICN was not effective until December 18, 1996.

Observation 1

CAR W97-013 was issued due to a deviation from NQA-3, Requirement 2.4, which requires the annual performance of management assessments. The corrective action for this CAR provided for the scheduling of a management assessment in April 1997. The corrective action was accepted by SNL WIPP QA and the CAR was closed out on January 9, 1997. The audit team is concerned that this corrective action is inappropriate and that the CAR should not be closed until the management assessment is completed.

Observation 2

CAO CAR 96-039 was issued due to deviations from SNL QAPs 13-1 and 13-2, which prescribe sample control and chain-of-custody, respectively. Numerous samples were transferred without proper chain-of-custody. The corrective action performed included revision of existing chain-of-custody forms for several samples. In addition, chain-of-custody forms were filled out for those samples which had been transferred without maintaining chain-of-custody. The audit team is concerned that the chain-of-custody forms were improperly used and, as a result, the data generated from the subject samples is legally inadmissible.

Observation 3

The software disaster recovery process does not readily describe the procedure by which the software configuration management system and the PA software will be restored with adequate assurance that superseded software versions will not be recreated as "current" versions.

Observation 4

[REDACTED]

The Validation Document Reviewer's Form should explicitly require the reviewer to confirm that the executed test cases are the same as the test cases listed in the Validation Plan document.

Observation 5

The definition of gradation provided in QAP 19-1 is not clearly stated. For example, if software is exempt from QAP 19-1, it will be qualified under QAP 9-1. This optional means of approving software demonstrates that gradation has a different meaning than the definition of grading set forth in NQA-1.

Observation 6

NQA-1, Requirement 5, requires procedures for activities which affect quality to have quantitative or qualitative acceptance criteria.

However, the format specified by QAP 5-1 for developing QAPs does not clearly include a section for acceptance criteria. No QAPs contain acceptance criteria.

M

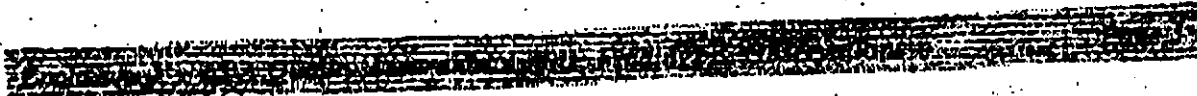

Enclosure 6

EPA Peer Review Audit Findings & Observations

On February 10-12, 1997, EPA performed an audit of DOE's documentation of its peer review processes conducted in support of the WIPP Compliance Certification Application to establish that they were conducted in a manner compatible with NUREG-1297, "Peer Review for High-Level Nuclear Waste Repositories," as required by 40 CFR Part 194.27(b). The audit team identified seven findings of relatively minor and isolated consequences during the audit. A finding is a specific nonconformance with an applicable NQA element or the element's implementing procedure. An observation is not a nonconformance, but does require a response like a finding. The findings and observations resulting from this audit are listed below.

Finding 1

NUREG-1297 states that Peer Reviewers should have sufficient freedom from funding considerations to assure the work is impartially reviewed.

To address this issue, the DOE's Carlsbad Area Office (CAO) included conflict of interest forms which require financial disclosure to identify whether a conflict exists. Mr. Evaristo Bonano and Ms. Patricia Robinson, members of the Waste Characterization Peer Review, checked that they had conflicts of interest but did not complete the required disclosure form.

Finding 2

NUREG-1297 states that in cases where total independence cannot be met, the peer review report should contain a documented rationale as to why someone of equivalent technical qualifications and greater independence was not selected.

A Non-Selection Justification form was included for the Waste Characterization Peer Review. Ms. Patricia Robinson, a Nuclear Engineer with a Master of Science Degree pending, was selected for the Waste Characterization Peer Review Panel. Ms. Robinson is currently employed by a DOE contractor. The form lists Dr. Peter K. Mart, a Nuclear Engineer with a Ph.D., and notes that other equally or more qualified individuals are available. From the form, it appears that persons of equivalent technical qualification were available but not selected. However, the Non-Selection Justification form does not document the rationale.

Finding 3

CAO Team Procedure TR 10.5 (Rev. 1), Section 3.1.3(c), requires peer review panel members be selected from a predetermined list of personnel. However, Section 5.4, the responsibilities

section of this procedure, states that the Peer Review Selection Committee shall generate a list of qualified Peer Reviewers using its knowledge of university contacts, professional organizations, and qualified industry professionals. A conflict exists within the procedure and should be revised.

Additionally, with the exception of the Engineered Alternatives Peer Review, neither a predetermined list nor a list generated from university contacts, professional organizations, and qualified industry professionals was located in the files reviewed.

Finding 4

CAO Team Procedure TP 10.5 (Rev. 1), Section 5.7, requires Peer Review Panel Members to complete and document the necessary training prior to the start of the Peer Review process.

Training forms for Mr. Chuan-Mian Zhang and Mr. Paul Cloke, members of the Natural Barriers Peer Review Panel, are dated May 15, 1996, while the meeting minutes of May 14, 1996, show them already in attendance.

Finding 5

CAO Team Procedure TP 10.5 (Rev. 1), Section 3.4.2, requires that all Peer Review Panel Members receive an orientation prior to the start of the Peer Review process. At a minimum, the orientation shall cover subjects or documents related to the Peer Review process, including administrative requirements, the applicable Peer Review Plan, a brief summary of the Peer Review technical subject matter, an overview of the requirements of TP 10.5, and any other appropriate topics.

Records indicate that Mr. David Sommaria did not receive administrative orientation prior to the start of the Peer Review process.

Finding 6

CAO Team Procedure TP 10.5 (Rev. 1), Section 3.4.2, requires that all Peer Review Panel Members receive an orientation prior to the start of the Peer Review process.

There is no evidence that Mr. Floris Caporuscio received orientation when the Conceptual Models Peer Review Panel reconvened in January 1997.

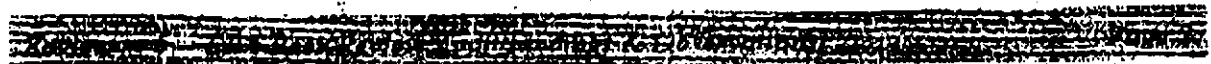

Finding 7

CAO Team Procedure TP 10.5 (Rev. 1), Section 3.4.4, requires minutes for all meetings, activities, and deliberations.

Minutes for the Natural Barriers Orientation Meeting conducted on May 14, 1996, were not included in the Peer Review file.

Observation 1

CAO Team Procedure TP 10.5 (Rev. 1), Section 3.1.3a, requires that the Selection Committee shall be impartial and have no organizational conflict of interest.

The appearance of a conflict of interest exist for both Peer Review Managers. The CAO Technical Assistance Contractor (CTAC) was tasked by CAO to contract for the management of the Peer Review process. Informatics, Inc., was selected. Mr. John Thies, Executive Vice President of Informatics and Peer Review Manager, selected Mr. Lolf Erikson of CTAC to serve on the selection committee. Mr. Thies also selected Informatics employees as Peer Reviewers.

Dr. Abbas Ghassami, Manager of Peer Review for Engineered Alternatives and Director of Special Programs for WERC, selected Dr. Ron Bhada, Administrative Director of WERC, to serve as Peer Review Panel Leader.

Observation 2

NUREG-1297 states that a rationale as to why someone of equivalent technical qualification and greater independence was not selected should be documented.

Several of the Engineered Alternative Peer Review panel members disclosed, in their Determination of Independence forms, current or previous affiliation with DOE. However, a documented rationale as to why someone of equivalent technical qualification and greater independence was not selected was not included with the support documents.

Observation 3

The Peer Review Selection Committee is required to document the rationale for selection of Peer Review Panel Members on a Peer Review Panel Selection, Size and Composition Justification/Decision Form.

A form was completed for each peer review, however, the form only repeats the requirements and does not provide a rationale for the selection of peer review panel members.

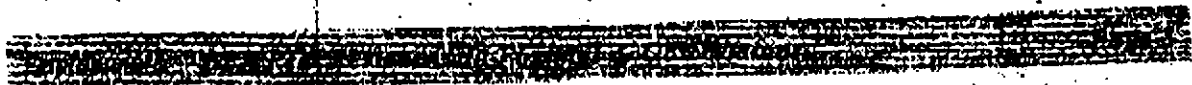

W

ATTACHMENT II



United States Environmental Protection Agency
Office of Radiation and Indoor Air (6602J)
Center for Waste Isolation Pilot Plant
401 M Street, S.W.
Washington, D.C. 20460

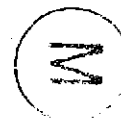

PAGES TO FOLLOW: 5

TO: Jim Mewhinney

TELEPHONE: (505) 234-7480

FAX NUMBER: (505) 234-7430

FROM: Frank Marcinowski

MAIL CODE: 6602J

TELEPHONE: (202) 233-9437

FAX NUMBER: (202) 233-9626

Information Only



UNITED STATES ENVIRONMENTAL PROTECTION AGENCY
WASHINGTON, D.C. 20460

OFFICE OF
AIR AND RADIATION

APR 25 1997

George Dials, Manager
Carlsbad Area Office
U.S. Department of Energy
P.O. Box 3090
Carlsbad, NM 88221-3090



Dear Mr. Dials:

This letter is a follow-up to the letter I sent to Alvin Alm, Assistant Secretary for Environmental Management, on March 19, 1997, regarding the U.S. Environmental Protection Agency's (EPA) review of the U.S. Department of Energy's (DOE) Compliance Certification Application for the Waste Isolation Pilot Plant (WIPP). In that letter, EPA identified lists of performance assessment (PA) input parameters for which EPA had questions about the value(s) selected.

In Enclosure 2, to the March 19, 1997 letter, EPA identified a list of performance assessment input parameters for which my staff had been unable to find supporting data. At that time, 13 key input parameters were either not supported by experimental or field data, or the data trail was untraceable. DOE and Sandia National Laboratory staff have since been able to identify data that were used as the bases for the values chosen for nine of the 13 parameters on the list. In addition, three parameters on the list were subsequently determined by my staff to be "non-sensitive" parameters (i.e., sensitivity analyses results indicate that the parameters do not have a significant impact on the results of the performance assessment). The one parameter remaining (#2, ID# 3246, Material BLOWOUT, Parameter PARTDIA, waste particle diameter in Cuttings Model for direct brine release) is considered "sensitive," but the value for that parameter is not supported by data. Therefore, the parameter value must be derived through "expert judgement" in accordance with EPA's WIPP Compliance Criteria at 40 C.F.R. §194.26 (expert judgment) and 40 C.F.R. §194.22(a)(2)(v) (quality assurance procedures for the implementation of expert judgment elicitation). The provisions of these regulatory requirements, including the requirements for documentation and public

participation, must be satisfactorily applied to the parameter value.

My staff has continued to review parameter values and conduct sensitivity analyses to determine the impact of other relevant parameters on the overall performance of the disposal system. On April 17, 1997, I transmitted a letter to you that included a list of parameters that are no longer in question, and a list of revised parameters values to use in running the BRAGFLO computer code. As I mentioned in my letter, the BRAGFLO parameter values were provided to DOE first because ERAGFLO is the first code to be activated in running the overall performance assessment (PA).

My staff has now completed the review of the remaining parameters identified in my March 19, 1997 letter. Enclosed are two tables: the first table includes parameters that are no longer in question; the second table includes important parameters and associated input values that EPA requires to be used in DOE's PA verification test.

Should you have questions, please call Frank Marcinowski at (202) 233-9310.

Sincerely,

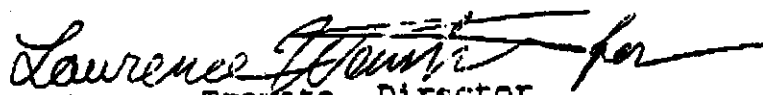
E. Ramona Trovato, Director
Office of Radiation and Indoor Air

Enclosures (2)

cc: Mary D. Nichols (EPA)
Alvin Alm (DOE/HQ)

Enclosure 1. Parameters identified in the March 19, 1997 letter, which have subsequently been determined by EPA, based on information provided by DOE and Sandia staff or through sensitivity analyses, to no longer be in question.

ID #	Material ID	Parameter ID	Description
64	CASTLER	POROSITY	Effective Porosity
66	CASTLER	PRESSURE	Brine Far-field Pore Pressure
651	WAS_AREA	ABSROUGH	Absolute Roughness of Material
653	WAS_AREA	COMP_RCK	Bulk Compressibility
3429	PHUMOX3	PHUMOX	Proportionality Constant Humic Colloids
3471	BLOWOUT	MAXFLOW	Maximum Blowout Flow
3472	BLOWOUT	MINFLOW	Minimum Blowout Flow
2177	S_MB_139	DPHIMAX	Incremental increase in porosity relative to intact conditions in the Salado Marker Bed 139
2180	S_MB_139	PF_DELTA	Incremental pressure for full fracture development
586	S_MB_139	PI_DELTA	Fracture initiation pressure increment
2178	S_MB_139	KMAXLOG	Log of max permeability in altered anhydrite flow model
3134	BH_OPEN	PRMX_LOG	Log of intrinsic permeability x - direction borehole unrestricted
2158	S_ANH_AB	DPHIMAX	Incremental increase in porosity relative to intact conditions in the Salado anhydrite beds A and B
214	EXP_AREA	PRMX_LOG	Log of intrinsic permeability, X-direction, experimental area
3473	BLOWOUT	THICK_CAST	Thickness of the Castile formation, direct brine releases
3456	BLOWOUT	RE_CAST	External drainage radius for the Castile formation, direct brine releases
3194	CASTLER	GRIDFLOW	Index for selecting brine pockets
3433	PHUMOX3	PHUMSIM	Proportionality constant of actinides in Salado Brine with humic colloids, inorganic
3470	BLOWOUT	GAS_MIN	Gas Rate Cutoff
3317	PU	PROPMIC	Microbial Proportionality Constant
3311	AM	PROPMIC	Microbial Proportionality Constant
2918	CASTLER	VOLUME	Total Reservoir Volume

Enclosure 2 WIPP Performance Assessment Parameters Identified in the March 19, 1997 Letter Which Have Been Determined To Not Be Representative of the Data DOE Must Use the Parameter Values Identified Below in the Performance Assessment Verification Test.

ID #	Material ID	Parameter ID	Description	Parameterization to be Used in Verification Test			
				Dist Type	Min	Median	Max
3493	GLOBAL	PDRINE	Probability of Encountering Pressurized Brine	Uniform	1%	30%	60%
2254	BOREHOLE	TAUFAIL	Waste Shear Strength	Dependent on Results of Particle Size Distribution Expert Elicitation. ¹			
27	BOREHOLE	OMEGA	Drill String Angular Velocity	Cumulative	4.2 rads/s	7.7 rads/s	23 rads/s
3245	BLOWOUT	CEMENT	Waste Cementation Strength	Log-uniform	TAUFAIL min ²	...	4.8E+06 Pa
3256 ⁴	BLOWOUT	IGE	Gravity Effectiveness Factor	Uniform	1	9.6	18.1
3259	BLOWOUT	APORO	Waste Permeability in CUTTINGS Model	Constant	n/a ³	2.4E-13 sq m	n/a
3405	SOLMOD6	SOLCIM	U(VI) Solubility Limits (Castile)	Constant	n/a	4.6E-3 M	n/a



¹The values for this parameter are dependent on the results of the expert elicitation for the particle size distribution. Once the particle size is established via the expert elicitation, TAUFAIL should be calculated based on Shields Parameter (see, for example, Simon, D.B. and Senturk, F., 1992, *Sediment Transport Technology: Water and Sediment Dynamics*) as a function of particle diameter.

²The minimum value should be set to the minimum value for TAUFAIL. If this parameter is no longer used in the performance assessment as a result of the 4/21/97 peer review, then no change to the parameter value is required.

³Once the minimum value for has been set to the minimum of TAUFAIL, the median value can be calculated based on the maximum and distribution type identified in the table.

⁴If the 4/21/97 peer review of the SPALLINGS conceptual model results in this parameter no longer being used in the performance assessment, then no change to the parameter value is required.

⁵Not Applicable

Enclosure 2 (cont)

WIPP Performance Assessment Parameters Identified in the March 19, 1997 Letter Which Have Been Determined To Not Be Representative of the Data. DOE Must Use the Parameter Values Identified Below in the Performance Assessment Verification Test.

ID #	Material ID	Parameter ID	Description	Parameterization to be Used in Verification Test			
				Dist Type	Min	Median	Max
3409 ⁶	SOLMOD6	SOLSIM	U(VI) Solubility Limits (Salado)	Constant	n/a	3.7E-5 M	n/a
3406	SOLMOD3	SOLSIM	Oxidation State +III Model (Salado)	Constant	n/a	1.2E-7 M	n/a
3402	SOLMOD3	SOLCIM	Oxidation State +III Model (Castile)	Constant	n/a	1.3E-8 M	n/a
3403	SOLMOD4	SOLCIM	Oxidation State +IV Model (Castile)	Constant	n/a	4.1E-8 M	n/a
3407	SOLMOD4	SOLSIM	Oxidation State +IV Model (Salado)	Constant	n/a	1.3E-8 M	n/a
3404	SOLMOD5	SOLCIM	Oxidation State +V Model (Castile)	Constant	n/a	4.8E-7 M	n/a
3404	SOLMOD5	SOLCIM	Oxidation State +V Model (Castile)	Constant	n/a	2.4E-7 M	n/a
3408	SOLMOD5	SOLSIM	Oxidation State +V Model (Salado)	Constant	n/a	2.4E-7 M	n/a
3482 ⁷	AM+3	MKD_AM	Matrix Partition Coefficient for Am +III	Log-uniform	20 m/g	100 m/g	500 m/g
3480	PU+3	MKD_PU	Matrix Partition Coefficient for Pu +III	Log-uniform	20 m/g	100 m/g	500 m/g
3461	PU+4	MKD_PU	Matrix Partition Coefficient for Pu +IV	Log-uniform	900 m/g	4,200 m/g	20,000 m/g
3479	U+4	MKD_U	Matrix Partition Coefficient for U +IV	Log-uniform	900 m/g	4,200 m/g	20,000 m/g
3475	U+6	MKD_U	Matrix Partition Coefficient for U +VI	Log-uniform	0.03 m/g	0.9 m/g	30 m/g

⁶In the 3/19/97 letter from Ramona Trovato to Alvin Alm, information from two separate parameters was inadvertently combined. The parameter identification number 3406 was assigned to material identification SOLMOD6 and should have been assigned to SOLMOD 3. Material identification SOLMOD6 should have had the identification number 3409. These discrepancies are accurately represented in the above table.

⁷All matrix coefficients used in the performance assessment should use the log-uniform distribution type.

ATTACHMENT III

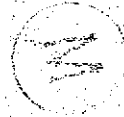



UNITED STATES ENVIRONMENTAL PROTECTION AGENCY
WASHINGTON, D.C. 20460

MAY 16 1997

THE ADMINISTRATOR

Honorable Federico Peña
Secretary
U.S. Department of Energy
1000 Independence Avenue, SW
Washington, DC 20585



Dear Mr. Secretary:

Pursuant to Section 8(d) of the Waste Isolation Pilot Plant (WIPP) Land Withdrawal Act, as amended, (the Act, or the LWA), and in accordance with the WIPP Compliance Criteria at 40 CFR §194.11, I hereby notify you that the U.S. Environmental Protection Agency (EPA) has determined that the U.S. Department of Energy's (DOE) Compliance Certification Application (CCA) for WIPP is complete. This completeness determination is a preliminary, interim determination required under the WIPP Compliance Criteria, which implement the Agency's Final Radioactive Waste Disposal Regulations at Subparts B and C of 40 CFR Part 191 (Disposal Regulations). While the completeness determination initiates the one-year evaluation period provided for in Section 8(d)(2) of the LWA, it does not have any generally applicable legal effect. Further, this determination does not imply or indicate that the CCA demonstrates compliance with the Compliance Criteria and/or the Disposal Regulations.

Section 8(d)(2) of the LWA requires EPA to certify whether WIPP complies with the Agency's Disposal Regulations. Section 8(d)(4) of the Act requires that EPA only perform such certification after DOE has submitted a "full" (or complete) application. Upon receipt of the CCA on October 29, 1996, EPA immediately commenced its review to determine whether the CCA was complete. Shortly thereafter, the Agency began to identify areas of the CCA that required supplementary information and analyses. In addition, EPA received numerous public comments on the CCA that identified areas of concern.

EPA identified completeness concerns in a December 19, 1996 letter from Mary Nichols, Assistant Administrator for the Office of Air and Radiation, to Alvin Alm, Assistant Secretary for Environmental Management. DOE responded with additional information, records packages, and clarifications, as necessary.

To the extent possible, the Agency has also been conducting a preliminary technical sufficiency review, and has provided the Department with relevant technical comments on an ongoing basis. EPA will continue to conduct its technical review of the CCA. The Agency will

issue its proposed compliance certification decision, in accordance with 40 CFR Part 194 and Part 191 Subparts B and C, after it has thoroughly evaluated the complete CCA and considered relevant public comments. Thank you for your cooperation during our review process. Should you have questions regarding this request, please contact Ramona Trovato at (202) 233-9320.

Sincerely,

Carol M. Browner

cc: Alvin Alm (DOE/HQ)
George Dials (DOE/CAO)
Ramona Trovato (EPA/ORIA)



APPENDIX A
ORIENTATION AND TRAINING MATERIALS

Best Copy Available

Information Only



GENERAL ORIENTATION

Expert Panel Elicitation on the Waste Isolation Pilot Plant (WIPP)

Waste Particle Diameter Size Distribution During the 10,000-year Regulatory Post-closure Period

**Conducted by: Carlsbad Area Office (CAO)
Technical Assistance Contractor (CTAC)
Carlsbad, New Mexico, May 5-9, 1997**

(W)

EXPERT PANEL ELICITATION ON WASTE PARTICLE DIAMETER General Orientation

- **Housekeeping**
- **Why**
- **What**
 - **WIPP containment system**
 - **Relationship between parameter and containment system**
 - **Relationship between parameter and containment system performance**
- **How**
- **When**

Expert Panel Elicitation on Waste Particle Diameter

Housekeeping

- Sign in
- Observer protocol
 - Panel will hear technical presentations from Sandia National Laboratories (SNL) staff and the public
 - Only elicitor and panel members may interact with presenters
 - Panel may request additional presentations by use of Panel Request Disposition Form
 - Observers may make presentations or ask questions by using Observer Request Disposition Form

W

Expert Panel Elicitation on Waste Particle Diameter Housekeeping

● Panel Request Disposition Form

Expert Elicitation on Waste Particle Diameter
Panel Member Request Disposition Form

Subject of Request:

Requestor: _____ Affiliation: _____ Date: _____
(Print Name)

Requestors - Do Not Write Below This Line

Administrative Action

Manager/Elicitor: _____ Request Number: _____ Provided On: _____
(Initials) (Date/Time)

Forwarded To: _____

Disposition:

Fax To: _____ Fax #: _____

Phone #: _____ # Pages: _____

From: _____ Phone #: _____

Usage: Use this form to request specific documents or information.

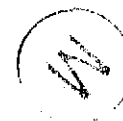

Expert Panel Elicitation on Waste Particle Diameter Housekeeping

● Observer Request Disposition Form

Expert Elicitation on Waste Particle Diameter Observer Request Disposition Form

Subject of Request:

Requestor: _____ Affiliation: _____ Date: _____
(Print Name)

Requestors - Do Not Write Below This Line

Administrative Action

Manager/Elicitor: _____ Request Number: _____ Provided On: _____
(Initials) (Date/Time)

Forwarded To: _____

Disposition:

Fax To: _____ Fax #: _____

Phone #: _____ # Pages: _____

From: _____ Phone #: _____

Usage: Use this form to request specific documents or information provided to the panel or to comment on the expert elicitation process.

Information Only

Expert Panel Elicitation on Waste Particle Diameter Housekeeping

- **Meeting recorded by court reporter**
 - **Transcript and/or reports provided upon request by calling 1-800-336-9777**

- **Reading material in meeting room**
 - **Book 1 - Curricula vitae**
 - **Book 2A and 2B - Reading material**
 - **Book 3 - Copies of presentation material**
 - **Compliance Certification Application CD-ROM**
 - **Updated agenda (Rev. 1)**

Expert Panel Elicitation on Waste Particle Diameter Housekeeping

- **Meeting recorded by court reporter**
 - **Transcript and/or reports provided upon request by calling 1-800-336-9477**
- **Reading material in meeting room**
 - **Book 1 - Curricula vitae**
 - **Book 2A and 2B - Reading material**
 - **Book 3 - Copies of presentation material**
 - **Compliance Certification Application CD-ROM**
 - **Updated agenda (Rev. 1)**

Expert Panel Elicitation on Waste Particle Diameter Housekeeping

Agenda (Rev. 1)

Monday, May 5, 1997

8:00 - 9:00	Introduction/Orientation	Leif Eriksson
9:00 - 10:00	Training	Bill Roberds
10:00 - 10:15	Break	
10:15 - 12:00	Training	Bill Roberds
12:00 - 1:00	Lunch	
1:00 - 1:30	BRAGFLO Model	Kurt Larson

M

Expert Panel Elicitation on Waste Particle Diameter Housekeeping

Agenda (Rev. 1)

Monday, May 5, 1997

- | | | |
|-------------|--|---------------|
| 1:30 - 2:30 | Evolution of the underground/waste
characterization/surrogate materials | |
| | Testing | Frank Hansen |
| 2:30 - 2:45 | Break | |
| 2:45 - 3:30 | Mechanically-based
conceptual models for
Spallings event | Kathy Knowles |

Information Only

Expert Panel Elicitation on Waste Particle Diameter Housekeeping

Agenda (Rev. 1)

Monday, May 5, 1997

M

3:30 - 4:00	Magnesium oxide (MgO) backfill	Hans Papenguth
4:00 - 4:45	TAUFAIL model	Kathy Knowles
4:45 - 5:00	Panel questions	Bill Roberds
5:00 - 6:30	Dinner	
6:30- ?	Public comments on waste particle diameter	Bill Roberds

Expert Panel Elicitation on Waste Particle Diameter Housekeeping

Agenda (Rev. 1)

Tuesday, May 6, 1997

- | | |
|---------------------|---|
| 7:30 - 12:00 | Panel members tour the WIPP facility |
| 12:00 - 1:00 | Lunch |
| 1:00 - 2:30 | Public presentations and questions to
the panel |
| | -EEG |
| | -? |
| | Panel discussion and development of
conceptual model for particle diameter |
| 2:30 - 2:45 | Break |

Expert Panel Elicitation on Waste Particle Diameter Housekeeping

Agenda (Rev. 1)

Tuesday, May 6, 1997

- | | |
|--------------------|---|
| 2:45 - 5:00 | Development of conceptual model for
particle diameter |
| 5:00 - 6:30 | Development of conceptual model for
particle diameter |
| 6:30 - ? | Development of conceptual model for
particle diameter (if necessary) |

M

Expert Panel Elicitation on Waste Particle Diameter

AGENDA (Rev. 2)

Tuesday, May 6, 1997

- | | |
|--------------|--|
| 7:30 -12:00 | Panel members tour WIPP facility |
| 12:00 - 1:00 | Lunch |
| 1:00 - | Public presentations and questions to the panel |
| | - EEG - "Particle Size in Existing TRU Wastes" |
| | - Other public participants, if any |
| - 2:30 | Panel discussion and development of conceptual model for particle diameter |
| 2:30 - 2:45 | Break |
| 2:45 - 5:00 | Development of conceptual model for particle diameter |
| 5:00 - 6:30 | Development of conceptual model for particle diameter (if necessary) |

5/6/97

Information Only

Expert Panel Elicitation on Waste Particle Diameter Housekeeping

Wednesday, May 7, 1997

- | | |
|----------------------|---|
| 8:00 - 10:15 | Development and preliminary
summarization of conceptual model |
| 10:15 - 10:30 | Break |
| 10:30 - 12:00 | Development and preliminary
summarization of conceptual model |
| 12:00 - 1:00 | Lunch |
| 1:00 - 2:30 | Public questions and comments
Finalization of conceptual model |

M

Expert Panel Elicitation on Waste Particle Diameter Housekeeping

Agenda (Rev. 1)

Wednesday, May 7, 1997

2:30 - 2:45

Break

2:30 - 5:00

Finalization of conceptual model

5:00 - 6:30

Dinner

6:30 - ?

Elicitation on input parameters



Expert Panel Elicitation on Waste Particle Diameter

Housekeeping

Agenda (Rev. 1)

Thursday, May 8, 1997

8:00 - 10:15

Elicitation on input parameters (if needed); summarization of input parameters; and preliminary model results

10:15 - 10:30

Break

10:30 - 12:00

Elicitation on input parameters (if needed); summarization of input parameters; and preliminary model results

12:00 - 1:00

Lunch

1:00 - 2:30

Public questions and comments
Reconsideration and finalization of input parameters

M

Expert Panel Elicitation on Waste Particle Diameter Housekeeping

Agenda (Rev. 1)

Thursday, May 8, 1997

2:30 - 2:45

Break

2:45 - 5:00

**Reconsideration and finalization of
input parameters**

5:00 - 6:30

Dinner

6:30 - ?

**Reconsideration and finalization of
input parameters (if necessary)**

Expert Panel Elicitation on Waste Particle Diameter Housekeeping

Agenda (Rev. 1)

Friday, May 9, 1997

8:00 - 10:15

**Verification of elicitation by
panel and documentation**

10:15 - 10:30

Break

10:30 - 12:00

**Verification of elicitation by
panel and documentation**

12:00

**Adjourn (if model and results are
completed)**

M

Expert Panel Elicitation on Waste Particle Diameter

Why

- **The WIPP Compliance Certification Application used waste particle diameter in the Spalling model**
- **The EPA requested expert judgment elicitation on the waste particle size distribution**
 - **March 19, 1997**
 - **April 25, 1997**



Undisturbed Performance Assessment Demonstrates No Releases For 10,000 years

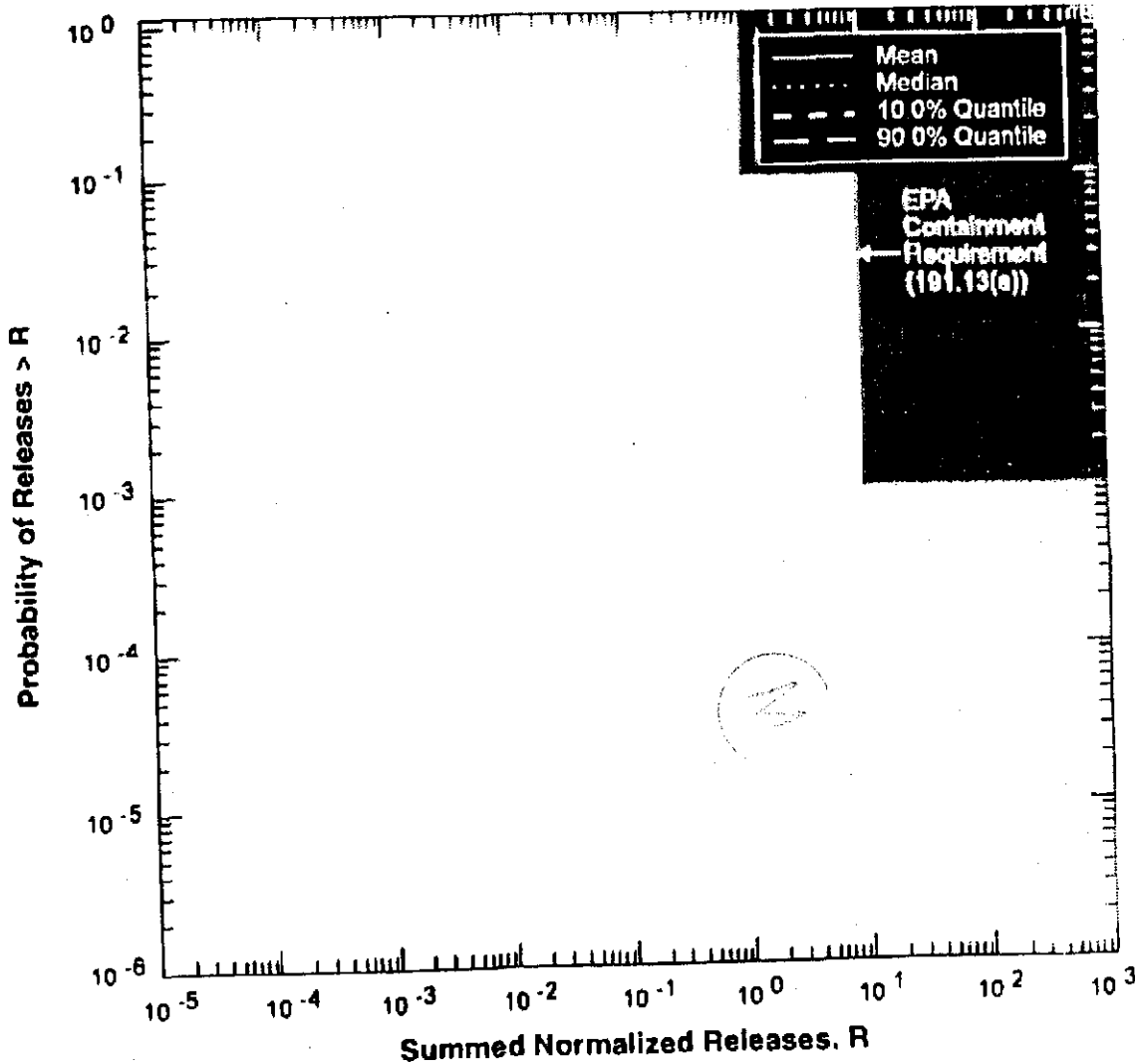

Expert Panel Elicitation on Waste Particle Diameter

Why

40CFR191.13(a) (Cont.)

- (1) have a likelihood of less than one chance in 10 of exceeding the quantities calculated according to Table 1 (Appendix A); and**
- (2) have a likelihood of less than one chance in 1,000 of exceeding ten times the quantities calculated according to Table 1 (Appendix A)**

Expert Panel Elicitation on Waste Particle Diameter

Why

40CFR191.13(a) CONTAINMENT REQUIREMENTS

- **Disposal systems for spent nuclear fuel or high-level or transuranic waste shall be designed to provide reasonable expectation, based upon performance assessment, that the cumulative releases of radionuclides to the accessible environment for 10,000-years after disposal from all significant processes and events that may affect the disposal system shall:**



Expert Panel Elicitation on Waste Particle Diameter

Performance assessment means:

An analysis that (1) identifies the processes and events that might affect the disposal system; (2) examines the effects of processes and events on the performance of the disposal system; and (3) estimates the cumulative releases of radionuclides, considering the associated uncertainties, caused by all significant processes and events. These estimates shall be incorporated into an overall probability distribution of cumulative releases to the extent practicable.

Expert Panel Elicitation on Waste Particle Diameter

Why

Preamble to 40 CFR 194:

Typically, expert judgment is used to elicit two types of information: (1) numerical values for parameters (variables) which are measurable only by experiments that cannot be conducted due to limitations of time, money, and physical situation; and (2) essentially unknowable information, such as which features should be incorporated into passive institutional controls that will deter human intrusion into the repository.



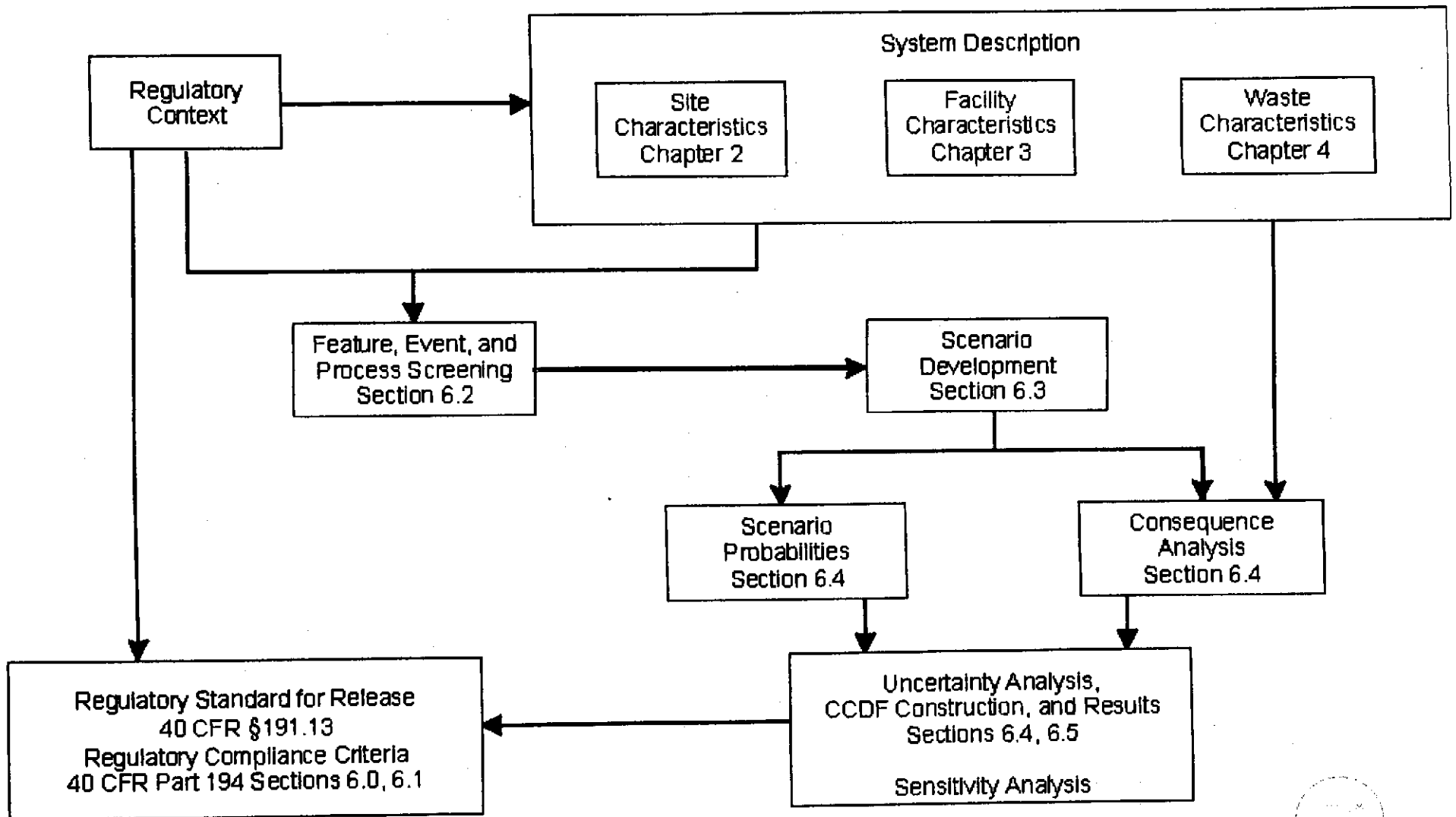

Note: All activities are conducted under QA procedures as discussed in Chapter 5.0.

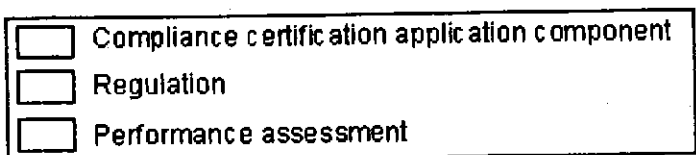

Figure 6-1. Methodology for Performance Assessment of the WIPP

A Model Train Analogy to Compliance

Models and data are improved and updated or brand new models (boxcars) are added to the PA train

PA activity planning and PA needs assessed
New Data "Hopper"

New & Revised Models Input Loop

PA Model Running Loop (Multiple Iterations)

Compliance Loop

Secretary's Decision

EPA

Stakeholders give input and program guidance

Peer Review

Check Point Are models & data packages complete?

Submit 1996 Compliance Packag

WIPP Models



Switch Tracks when all models & data are complete

Models for individual components of the WIPP system can be thought of as separate boxcars linked together and driven by the PA engine. SNL determines which boxcars to improve, add, or remove. When all models and data are complete, the track will switch and the train will go through the EPA "Tunnel of Compliance." The EPA will switch the train to either the "yes" or "no" track at the end of the tunnel.



496F:6938n

Expert Panel Elicitation on Waste Particle Diameter

What

- **Scope**

- **To elicit expert judgment on WIPP waste particle diameter size distribution(s) during the 10,000-year regulatory post-closure period.**

Expert Panel Elicitation on Waste Particle Diameter

How

- **Format and requirements for expert judgment defined by EPA in 40 CFR 194.26**
- **Additional EPA guidance on expert judgment provided in the Certification Application Guidance for 40 CFR 194 document**



Expert Panel Elicitation on Waste Particle Diameter

How

- **CAO developed procedure (TP 10.6) and plan (DOE/CAO-97-223) for expert judgment elicitation defining:**
 - **Scope**
 - **Process (including organization)**
 - **Estimated resources**
 - **Estimated schedule**



Expert Panel Elicitation on Waste Particle Diameter How

Process

- **Main governing documents**
 - **40 CFR 194.26**
 - **CAO team procedure (TP 10.6, Rev. 1)
expert judgment**
 - **CAO Expert Panel Elicitation Plan
(DOE/CAO-97-2223, (REV. 2)**
 - **CTAC desktop instruction (CTAC/EP-DI1,
Rev. 0)**

Expert Panel Elicitation on Waste Particle Diameter How

Process

- **Main steps**
 - **Definition of technical issue(s)**
 - **Public notification**
 - **Selection of and contracting with expert**
 - **General orientation and elicitation training**
 - **Presentation and review of issues**
 - **Preparation of expert analysis by elicitor**

Expert Panel Elicitation on Waste Particle Diameter

How

Process

- **Main steps**
 - **Discussion of analysis by panel members**
 - **Elicitation**
 - **Recomposition and aggregation**
 - **Review and approved or dissenting opinions provided by experts**
 - **Public review of final draft report**
 - **Preparation of final report and documentation of process**



Expert Panel Elicitation on Waste Particle Diameter How

Process

- **Main organizations/key participants**
 - **CAO assistant manager, Office of Regulatory Compliance (ORC)**
 - **ORC Expert Panel coordinator**
 - **CTAC administrative manager**
 - **Elicitor/facilitator**
 - **Expert Panel Selection Committee**
 - **Sandia National Laboratories staff**



Expert Panel Elicitation on Waste Particle Diameter How

Process

- **Main roles and responsibilities - CAO assistant manager, ORC**
 - **Responsible for development of expert judgment procedure and plan**
 - **Appoints ORC Expert Panel Coordinator**
 - **Appoints Expert Panel manager**



Expert Panel Elicitation on Waste Particle Diameter

How

Process

- **Main roles and responsibilities - ORC Expert Panel coordinator**
 - **Definition of scope of work**
 - **Development of Expert Panel Elicitation Plan**
 - **Interface with CAO assistant manager, ORC; CAO Public Affairs; Expert Panel manager; and SNL's management staff**

Expert Panel Elicitation on Waste Particle Diameter

How

Process

- **Main roles and responsibilities - Expert Panel manager**
 - **Selects elicitor/facilitator**
 - **Selects two other members of selection committee**
 - **Establishes availability among nominated potential Expert Panel members**

4

Expert Panel Elicitation on Waste Particle Diameter How

Process

Main roles and responsibilities - Expert Panel manager

- Contracts with panel members**
- Interfaces with the CAO-ORC, SNL, and WID
staff involved in presentations and WIPP
site tour**
- Coordinates the preparation of reports**
- Maintains administrative record (QA files)**



Expert Panel Elicitation on Waste Particle Diameter

How

Process

- **Main roles and responsibilities - Elicitor/facilitator**
 - **Trains Expert Panel members**
 - **Facilitates and controls the meeting**
 - **Interfaces with Expert Panel manager, Expert Panel members, presenters, and observers**



Expert Panel Elicitation on Waste Particle Diameter How

Process

- **Main roles and responsibilities - The Selection Committee**
- **Evaluates resource requirements to conduct scope of work defined in Expert Panel Elicitation Plan**
- **Evaluates, nominates potential candidates for Expert Panel**

Expert Panel Elicitation on Waste Particle Diameter How

Process

- **Main organizations/key participants - Observers**
 - **Expert Panel (six members)**
 - **Archaeology (1 expert)**
 - **Chemistry (2 experts)**
 - **Rock/soil and/or fluid mechanics (1 expert)**
 - **Performance assessment (1 expert)**



Expert Panel Elicitation on Waste Particle Diameter How

Process

- **Main organizations/key participants - Observers**
 - **Expert Panel (six members)**
 - **Archaeology (1 expert)**
 - **Chemistry (2 experts)**
 - **Rock/soil and/or fluid mechanics (1 expert)**
 - **Performance assessment (1 expert)**
 - **Generalist (1 expert)**



Expert Panel Elicitation on Waste Particle Diameter How

Process

- **Main roles and responsibilities - SNL point of contact**
 - **Coordinates SNL's technical presentations**
 - **Responsible for making SNL staff and information available, as requested by Expert Panel**
 - **Interfaces with CAO-ORC, WID, and CTAC staff**

Expert Panel Elicitation on Waste Particle Diameter How

Process

- **Main roles and responsibilities - Observers**
 - Entitled to make presentations pertinent to WIPP waste particle diameter
 - Contingent upon approval by Expert Panel manager, facilitator, and Expert Panel members
 - Follow observer protocol

Expert Panel Elicitation on Waste Particle Diameter

How

ORGANIZATION/KEY PARTICIPANTS WASTE PARTICLE DIAMETER ELICITATION

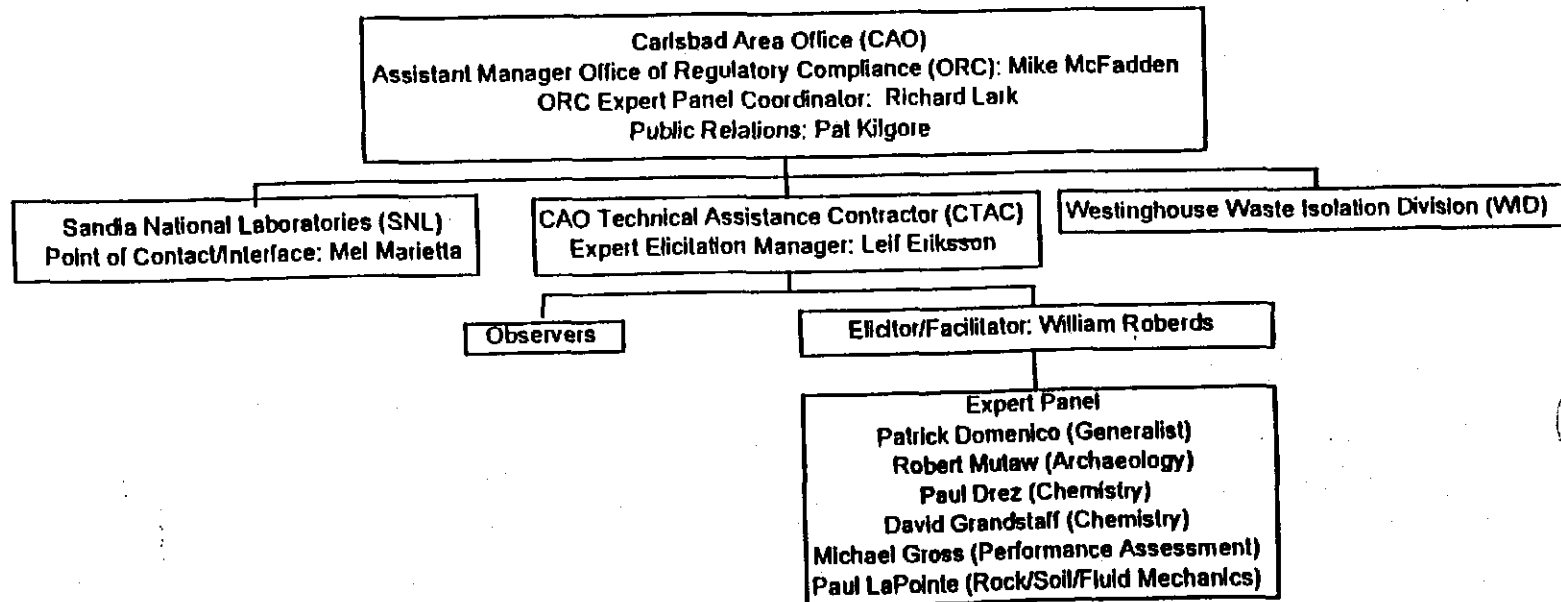

Expert Panel Elicitation on Waste Particle Diameter How

WIPP Containment System

- **Waste form (waste characteristics)**
- **Subsurface facilities with engineered barriers**
- **Facility characteristics, including backfill**
- **Natural containment barriers within the controlled area (site characteristics)**



MAIN RADIOACTIVE WASTE TYPES

- Low-level radioactive waste (LLW)
- Transuranic radioactive waste (TRUW)
 - Atomic weights > uranium
 - 3,700 becquerels of alpha-emitting transuranic isotopes per gram of waste
 - Half life > 20 years
- Spent nuclear fuel and other high-level radioactive wastes (HLW)



596R:6962i

DIFFERENT TYPES OF TRUW

- **Contact-handled**

- Activity between 3,700 becquerels (Bq)/gram and 0.002 sievert (Sv)/hour
- WIPP capacity ≥ 168.504 cubic meters (m^3)

- **Remote-handled**

- Activity between ≥ 0.002 Sv/hour and 10 Sv/hour
- WIPP capacity $\leq 7.080 m^3$
- Only up to 5% of total RH TRUW volume, i.e. $\leq 354 m^3$, can be above 0.1 Sv/hour

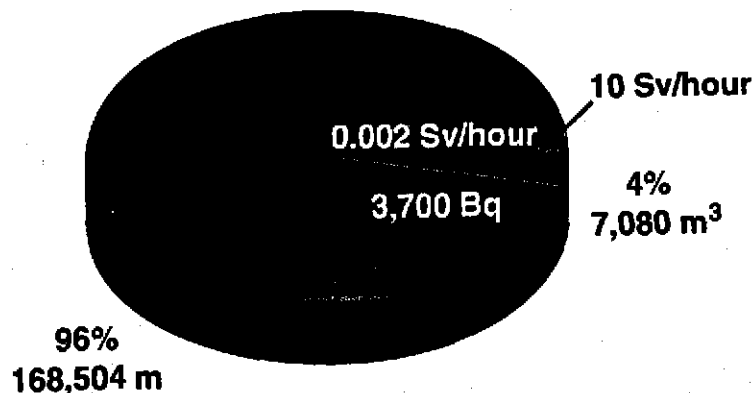



596R:6962w

Expert Panel Elicitation on Waste Particle Diameter How

Relationship between parameter and containment system

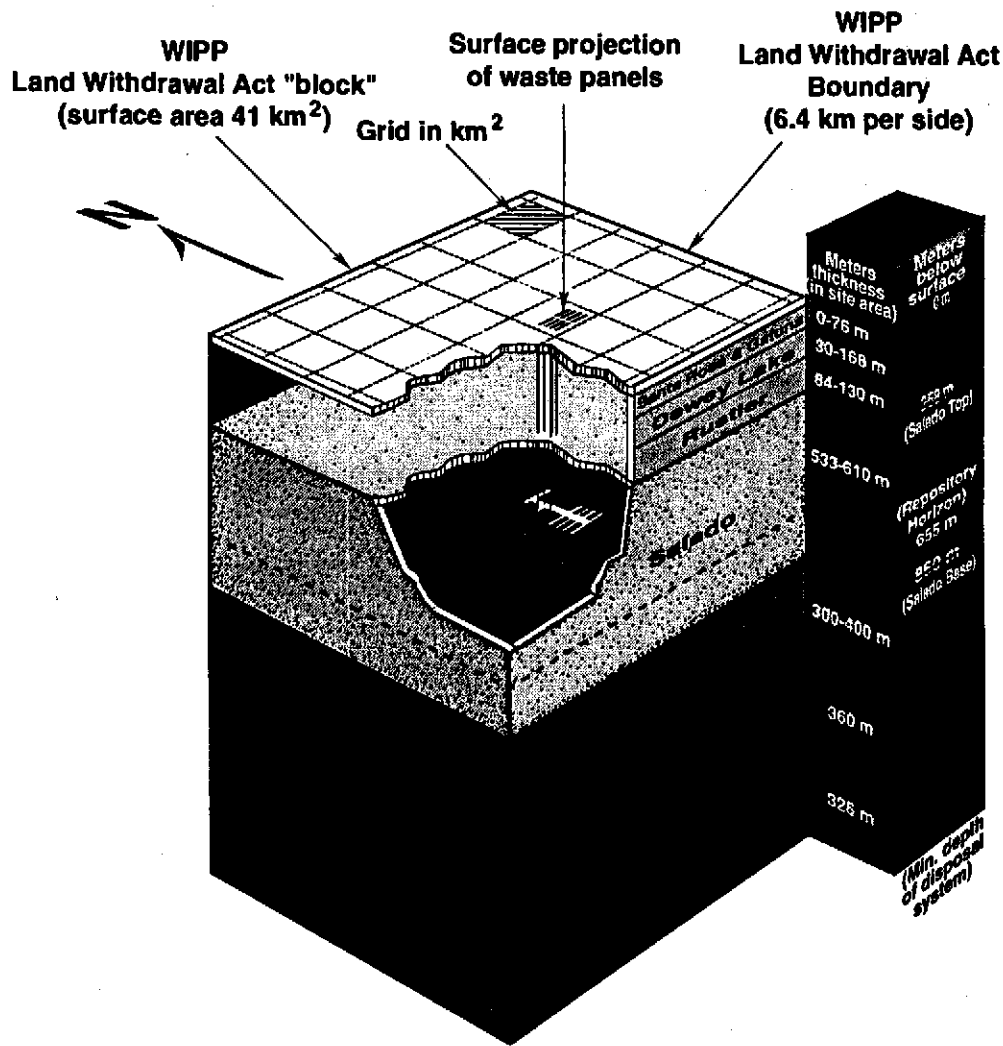
- **Influenced by post-closure processes and events induced by one or more containment system components, i.e., waste form, engineered systems/barriers, and the geologic setting**



-  40 CFR 191/194 Disposal System
-  40 CFR 268 Disposal Unit

Note:
 At the WIPP site, the horizontal area of the "40 CFR 268 Disposal Unit" and the "40 CFR 191 Disposal System" are identical but the thickness of the "40 CFR 268 Disposal Unit" is only about 33% of and included in the "40 CFR 191 Disposal System."

Scale is proportional but vertical scale is exaggerated



496R:69380

WIPP FACILITY AND STRATIGRAPHIC SEQUENCE

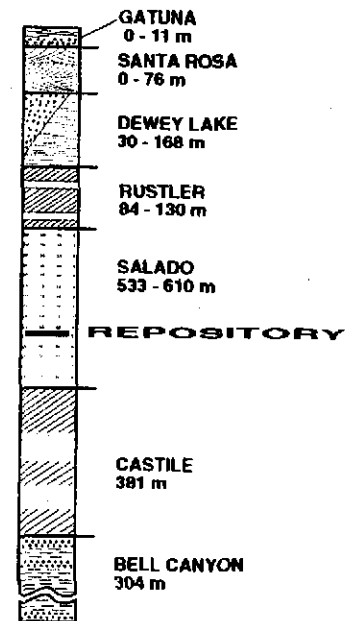
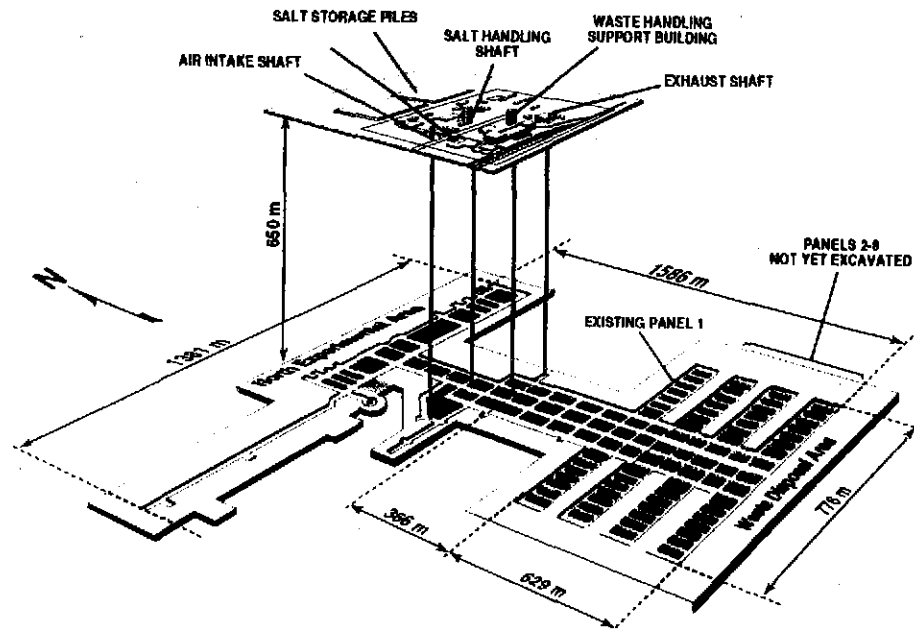

"The best means of long-term disposal... is deep geological emplacement...."

National Academy of Sciences



596R:6962u

Information Only

Time - 0 years

Anhydrite b

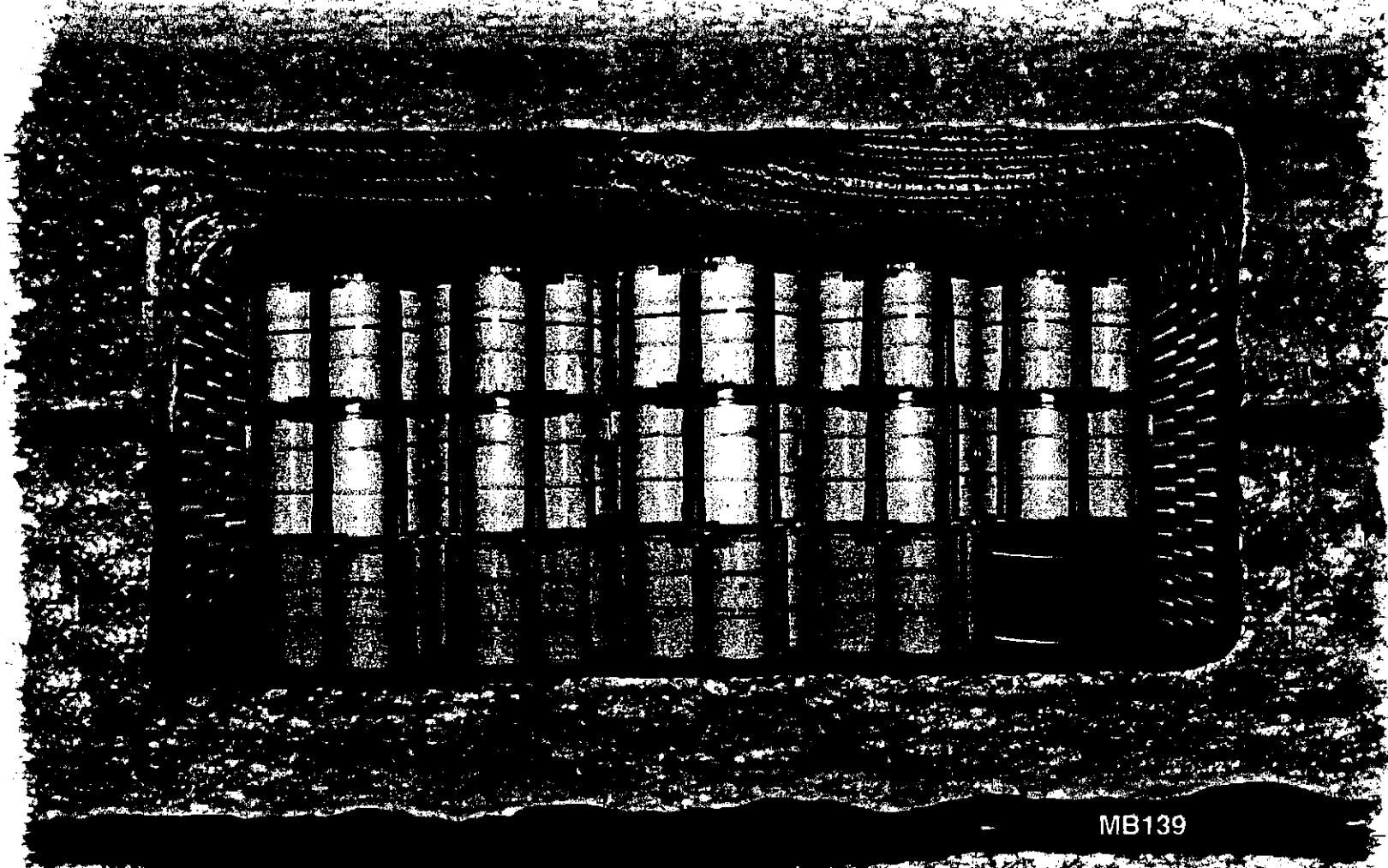

MB139

M

4051-0

Information Only

Time - 10-15 years

Anhydrite b

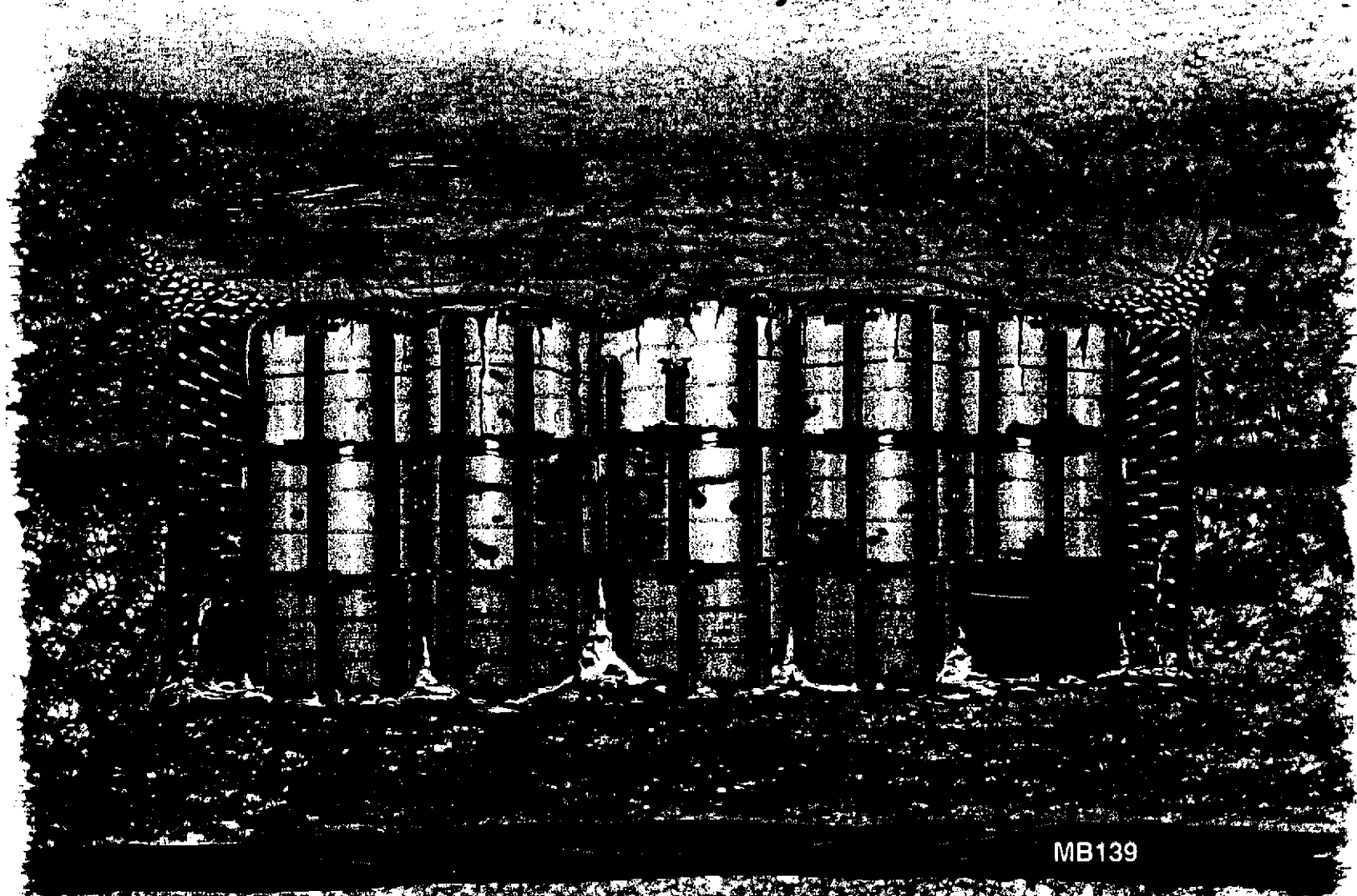

MB139

M

Time - 50 years

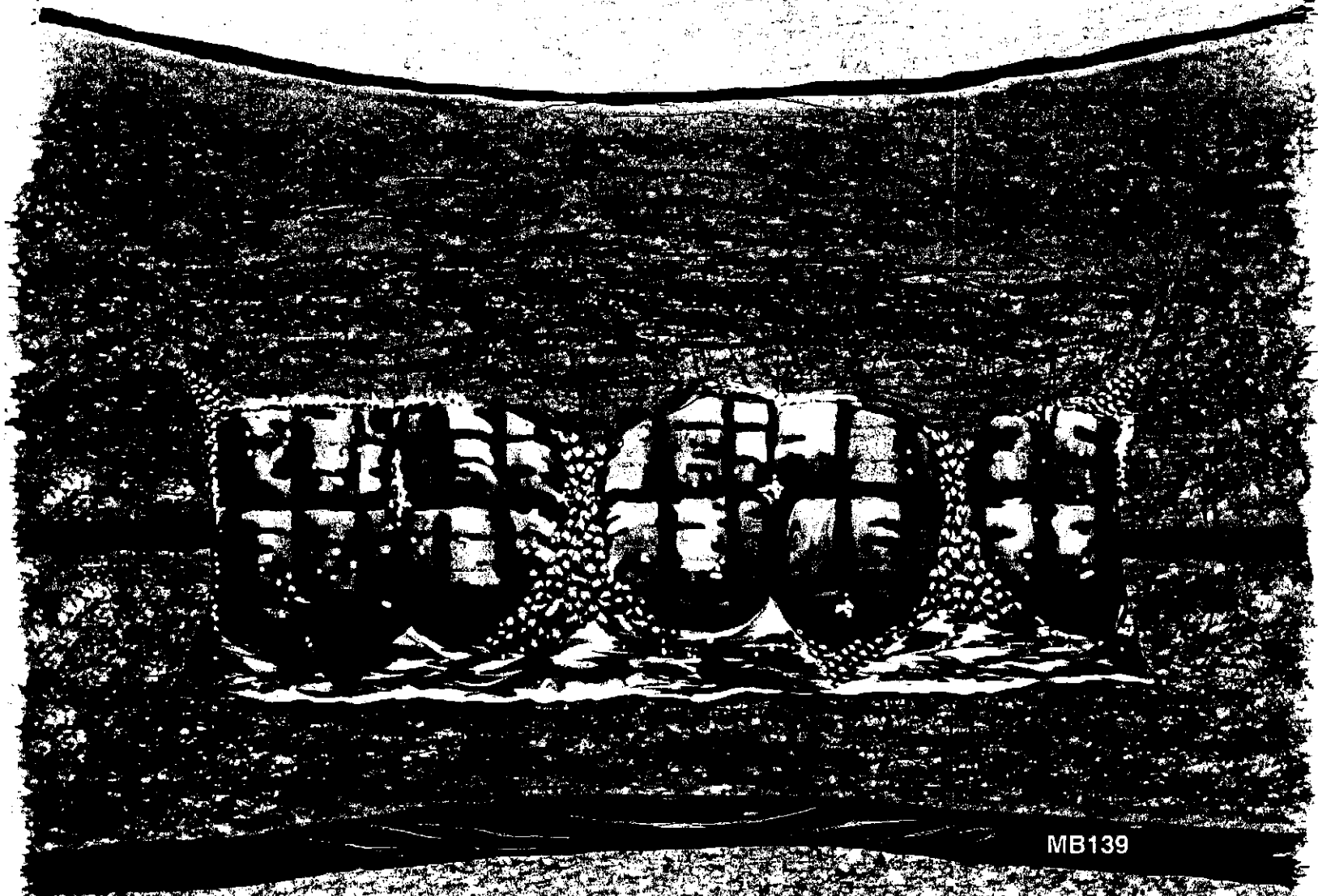

MB139

M

Time - 1000 years +

Anhydrite b

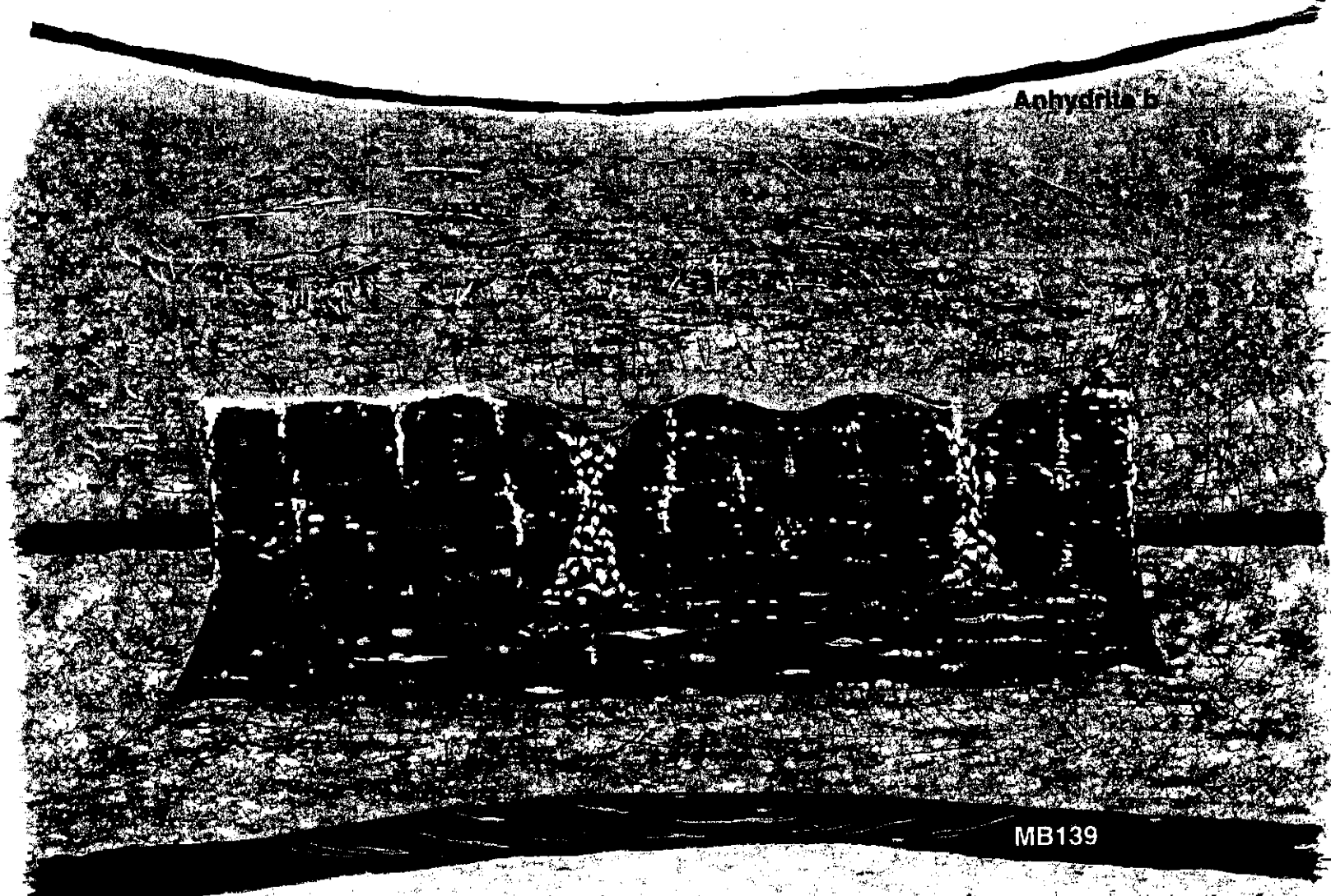

MB139

MA

3054-0

Information Only

Expert Panel Elicitation on Waste Particle Diameter How

*Relationship between parameter and
containment system performance*

- **Inadvertent borehole intrusion(s)**
 - **Spalling**
 - **Cuttings**
 - **Cavings**
 - **Direct brine release(s)**

Expert Panel Elicitation on Waste Particle Diameter How

Cuttings

- **Waste contained in the cylindrical volume created by the cutting action of the drill bit passing through the waste (including backfill)**



Expert Panel Elicitation on Waste Particle Diameter How

Cavings

- **Waste (including backfill) that erodes from the borehole in response to upward-flowing drilling fluid within the annulus between the rock and the drill stem**



Expert Panel Elicitation on Waste Particle Diameter

How

Spalling

- **Waste (including backfill) introduced into the drilling fluid caused by the release of waste-generated gas escaping to the ground surface through the lower-pressure borehole.**
 - **Requires a repository gas pressure that exceeds the hydrostatic pressure of the drilling mud**



Expert Panel Elicitation on Waste Particle Diameter How

Direct brine release

- **Waste (including backfill) introduced into the drilling fluid caused by an overpressurized waste room and brine escaping to the ground surface through the lower-pressure borehole.**
 - **Requires a repository brine pressure that exceeds the hydrostatic pressure of the drilling mud**



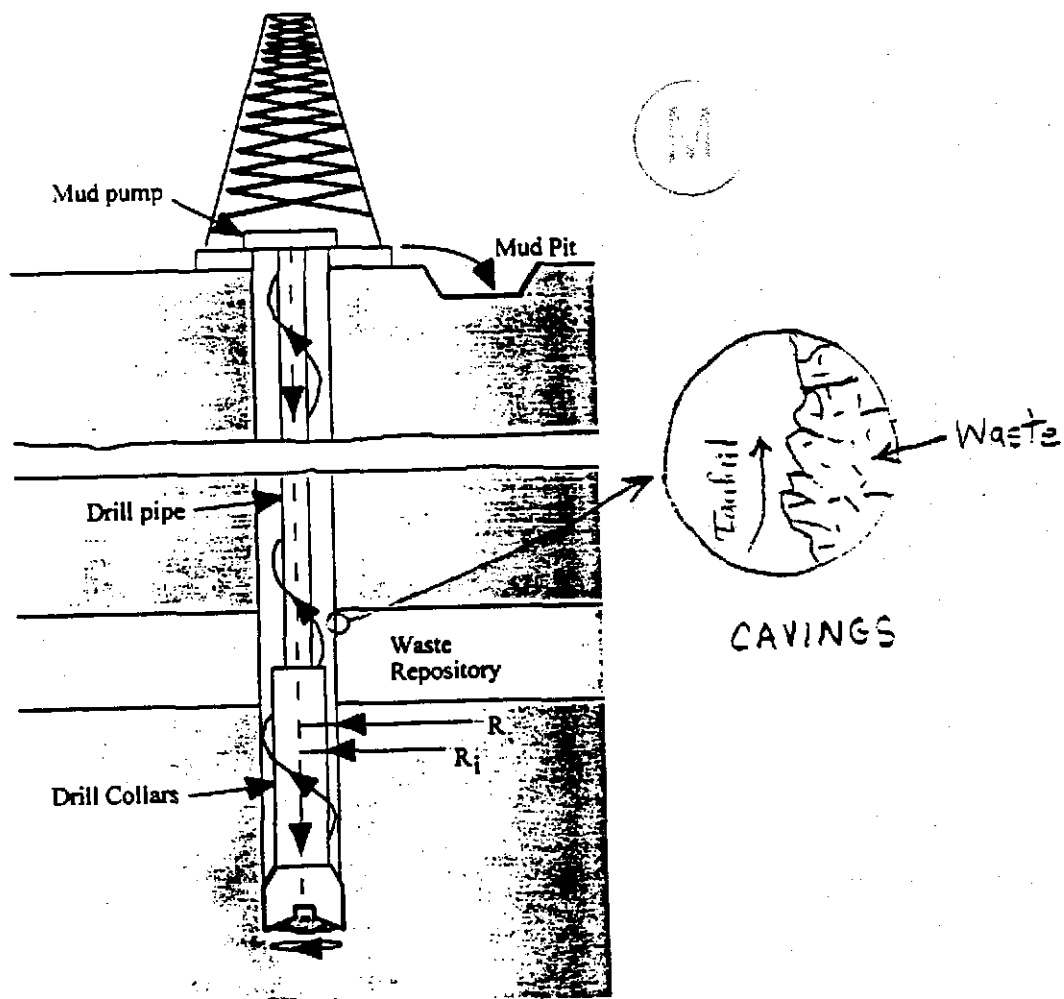
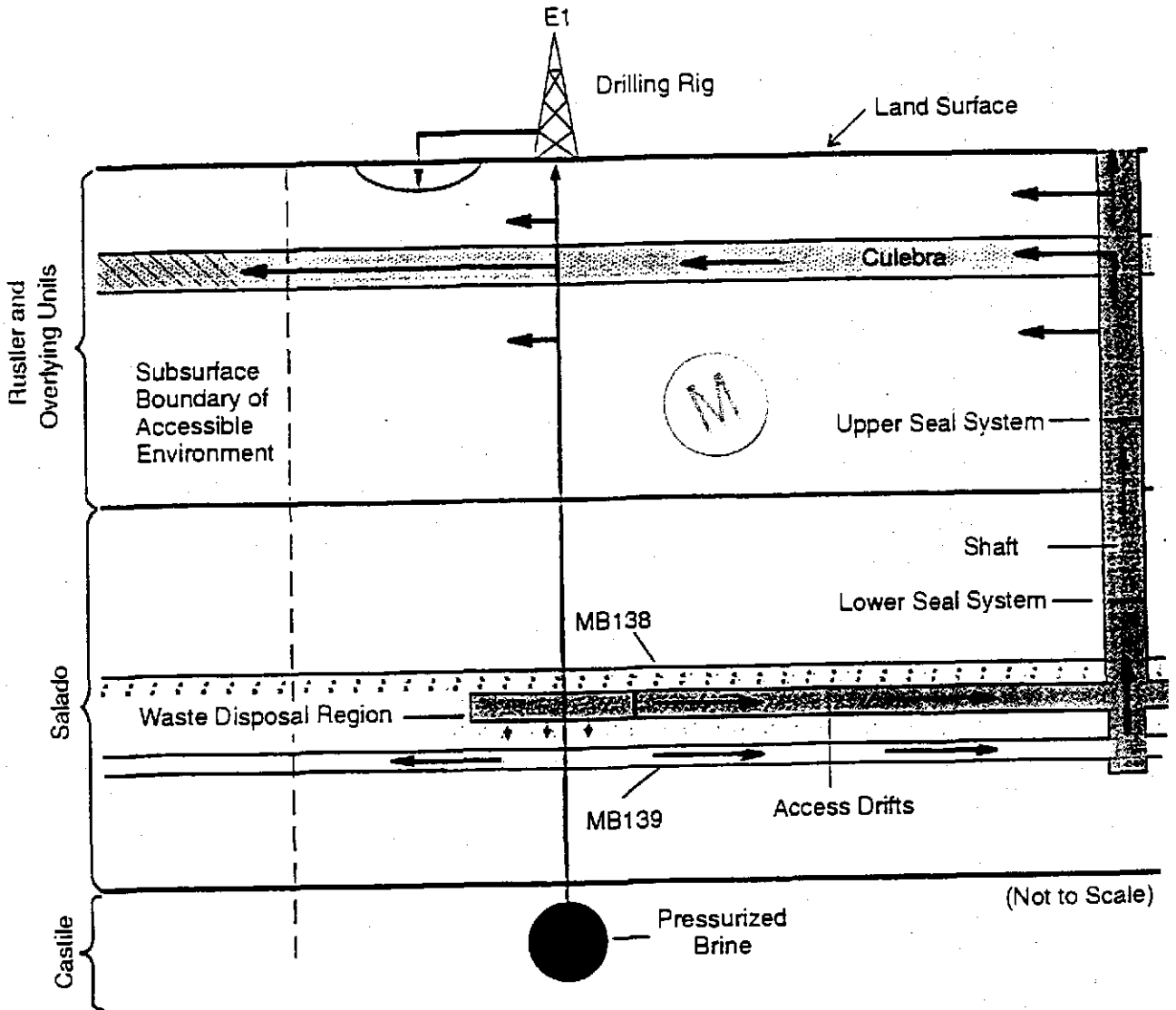

Figure 3. Detail of rotary drill string adjacent to repository.



Note: Borehole penetrates waste and pressurized brine in the underlying Castile Formation. Arrows indicate hypothetical direction of groundwater flow and radionuclide transport.

- Anhydrite layers a and b
- ▨ Culebra
- ▬ Groundwater flow and radionuclide transport
- ▭ Disturbed rock zone
- ▨ Repository and shafts
- ▨ Increase in Culebra hydraulic conductivity due to mining

JCA-010-2

Figure 6-11. Conceptual Release Pathways for the Disturbed Performance Deep Drilling Scenario E1

CONCEPTUAL MODEL FOR SCENARIO E1E2

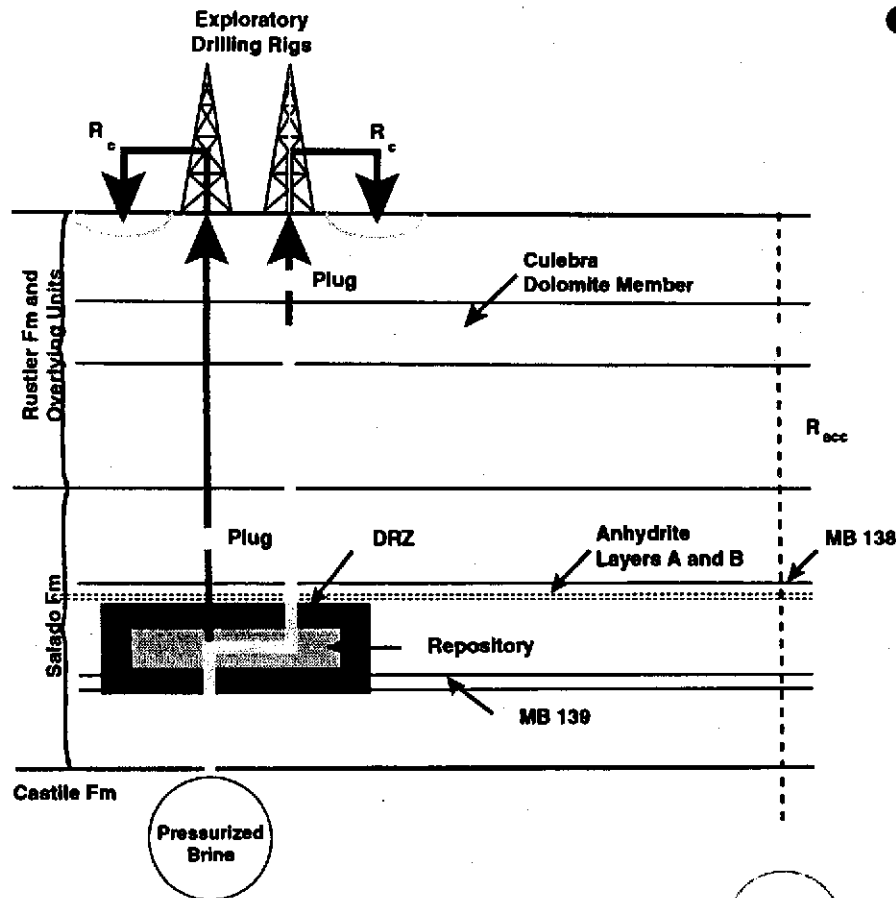

* Not to Scale

● Disturbed performance assessment consists of:

- Inadvertent human intrusion
- Connects repository to Castile brine pocket
- Considers potash mining
- Considers all events that have one chance in 10,000 years of occurring
- Probabilistic determination for 10,000 years
- Ninety-five percent statistical confidence level in the mean



596H:6949h5

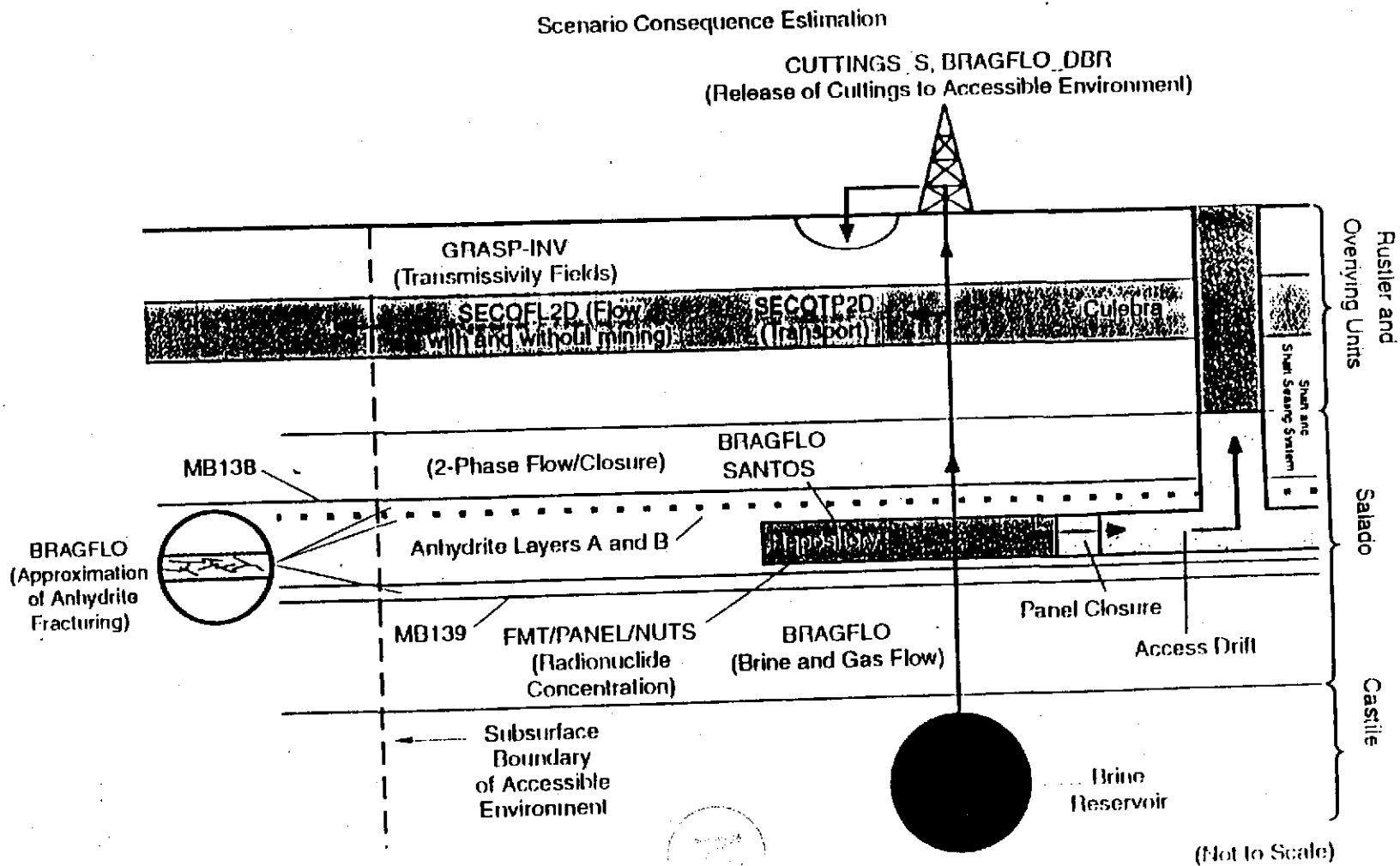

Title 40 CFR Part 191 Compliance Certification Application

DOE/CAO 0132

Figure 6-26. Schematic Side View of the Disposal System Associating Performance Assessment Codes with the Components of the Disposal System Each Code Simulates

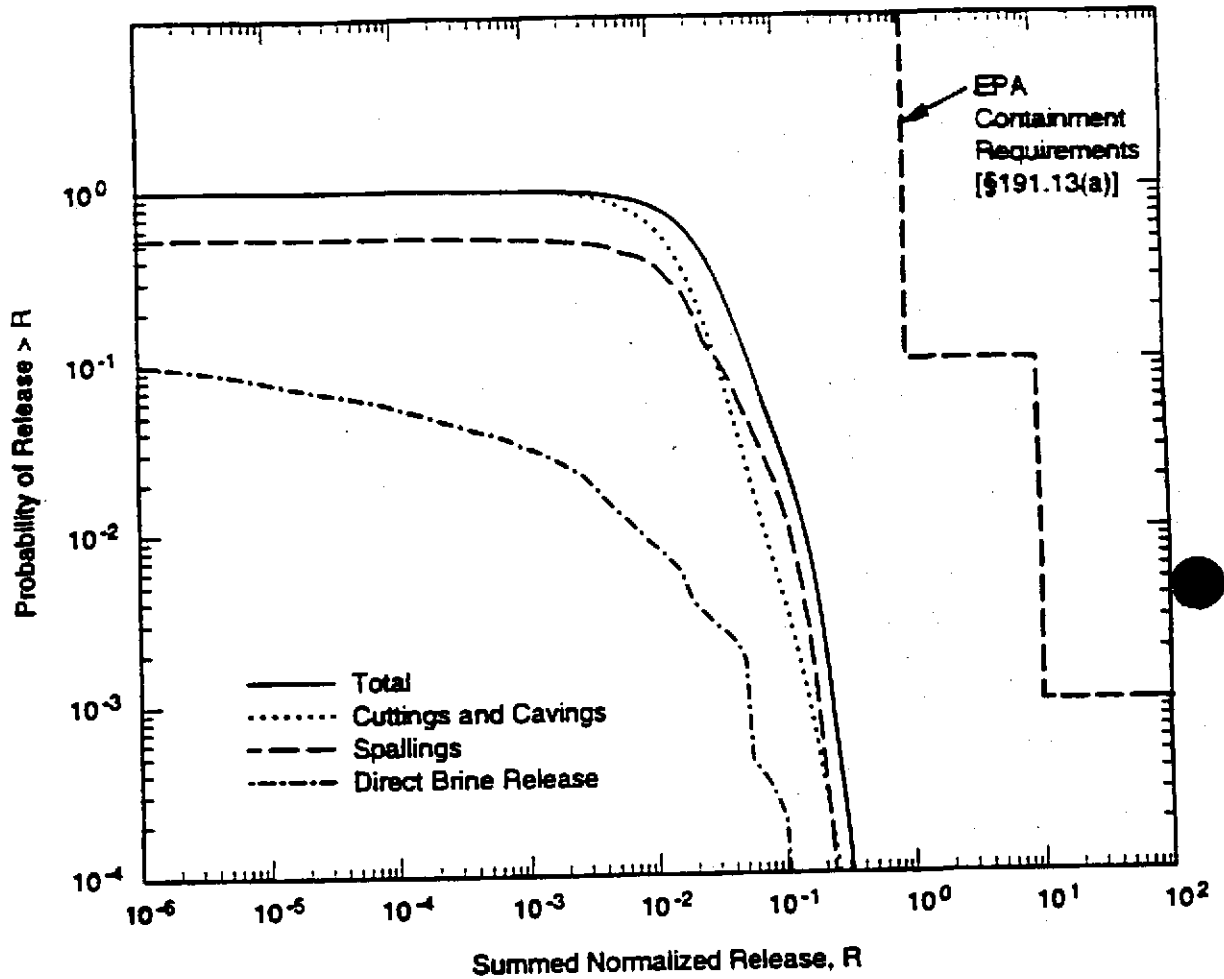

CCA-140-3

Note: Mean CCDFs are shown for the total normalized release (this curve is also shown in Figure 6-40 and is the mean of the family shown in Figure 6-35) and for the normalized releases resulting from cuttings and cavings, spallings, and direct brine release. The mean CCDF for subsurface releases resulting from groundwater transport is not shown because those releases were less than 10⁻⁶ EPA units and the CCDF cannot be shown at the scale of this figure.

Figure 6-41. Mean CCDFs for Specific Release Modes, Replicate 1

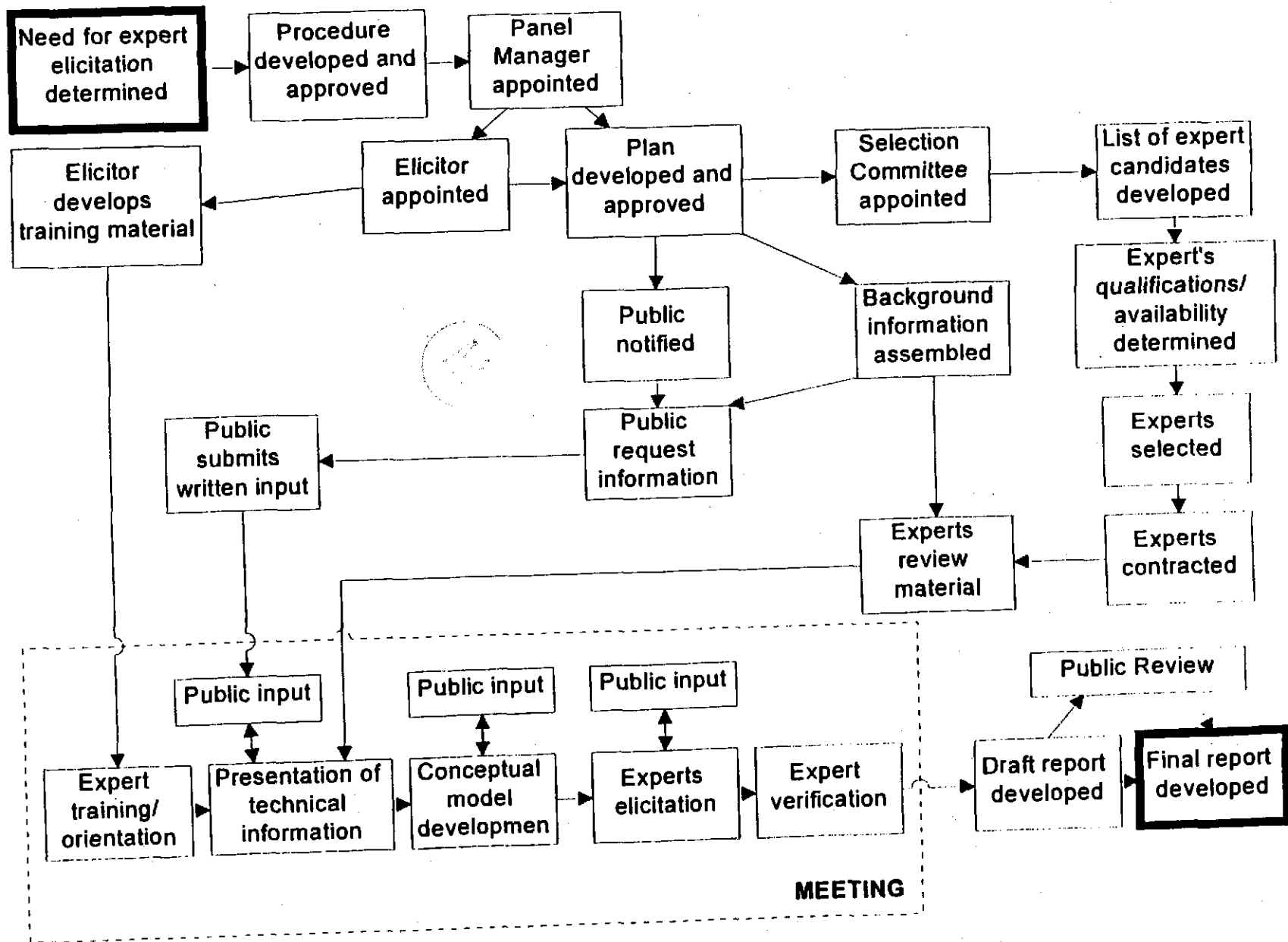

Figure 1. Schematic of Expert Elicitation Process

Expert Panel Elicitation on Waste Particle Diameter

When

Schedule

- CAO approves procedure TP 10.6 for expert judgment 4/14/97
- CAO approves Expert Panel Elicitation Plan (DOE/CAO-97-223) 4/21/97
- Expert Panel manager nominates Selection Committee members and elicitor/facilitator 4/21/97



Expert Panel Elicitation on Waste Particle Diameter When

Schedule

- **Public Notice 1** **4/21/97**
- **Selection Committee meets and
nominates Expert Panel
candidates** **4/22/97**
- **CTAC contracts with panel
members** **4/23-5/2/97**
- **Expert Panel meets in Carlsbad,
N.M., prepares draft report** **5/5-5/9/97**

Expert Panel Elicitation on Waste Particle Diameter

When

Schedule

- **Completion of final draft report** **5/12/97**
- **End of public comment period on final draft report** **5/27/97**
- **Completion of final report**
 - **Contingent upon the extent of pertinent public technical comments** **5/31/97**

14

A Model Train Analogy to Compliance

Models and data are improved and updated or brand new models (Boxcars) are added to the PA train

PA activity planning and PA needs assessed

New Data "Hopper"

New & Revised Models Input Loop

PA Model Running Loop
(Multiple Iterations)

Stakeholders give input and program guidance

Peer Review

Check Point
Are models & data packages complete?

Submit 1996 Compliance Package

Switch Tracks when all models & data are complete

Secretary's Decision

yes

no

Compliance Loop

EPA

Models for individual components of the WIPP system can be thought of as separate boxcars linked together and driven by the PA engine. SNL determines which boxcars to improve, add, or remove. When all models and data are complete, the track will switch and the train will go through the EPA "Tunnel of Compliance." The EPA will switch the train to either the "yes" or "no" track at the end of the tunnel.



TRAINING



 **Expert Elicitation on
WIPP Waste Particle Diameter Size Distribution(s)
during the 10,000 Year Regulatory Post-Closure Period**

Probability/Elicitation Training

 **Dr. Wm. J. Roberds
Golder Associates Inc.**

Carlsbad, NM

May 05, 1997

© Copyright 1997

PR3 1930.301/63487.ppt



Information Only



Workshop Objectives

- Familiarize Subject Matter Experts (SME's)
 - variability and uncertainty
 - quantification of uncertainties (*probabilities*)
 - decomposition
 - assessment procedures and potential problems
 - elicitation procedures
- Provide context for review of technical information prior to actual elicitation
- Prepare for actual elicitation

14

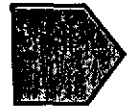

Workshop Topics

■ *Parameters*

- types
- assessments

■ *Uncertainty*

- meaning
- sources

■ *Probability*

- types
- assessments

■ *Elicitation*

- potential problems
- procedures



Types of Parameters

- *Binary (Boolean)* - one of two possible values (x, x')
- *Discrete* - one of finite set of possible values (x_j)
- *Continuous* - one of infinite set of possible values ($x_{min} < x < x_{max}$)
- *Population* - one set (of various possible sets) of values for each member of “population” (*variability* in group, time or space) (x)
- *Combinations* - one set (of various possible sets) of values for different parameters (*correlation*) (x, y)



Example (1 of 2)

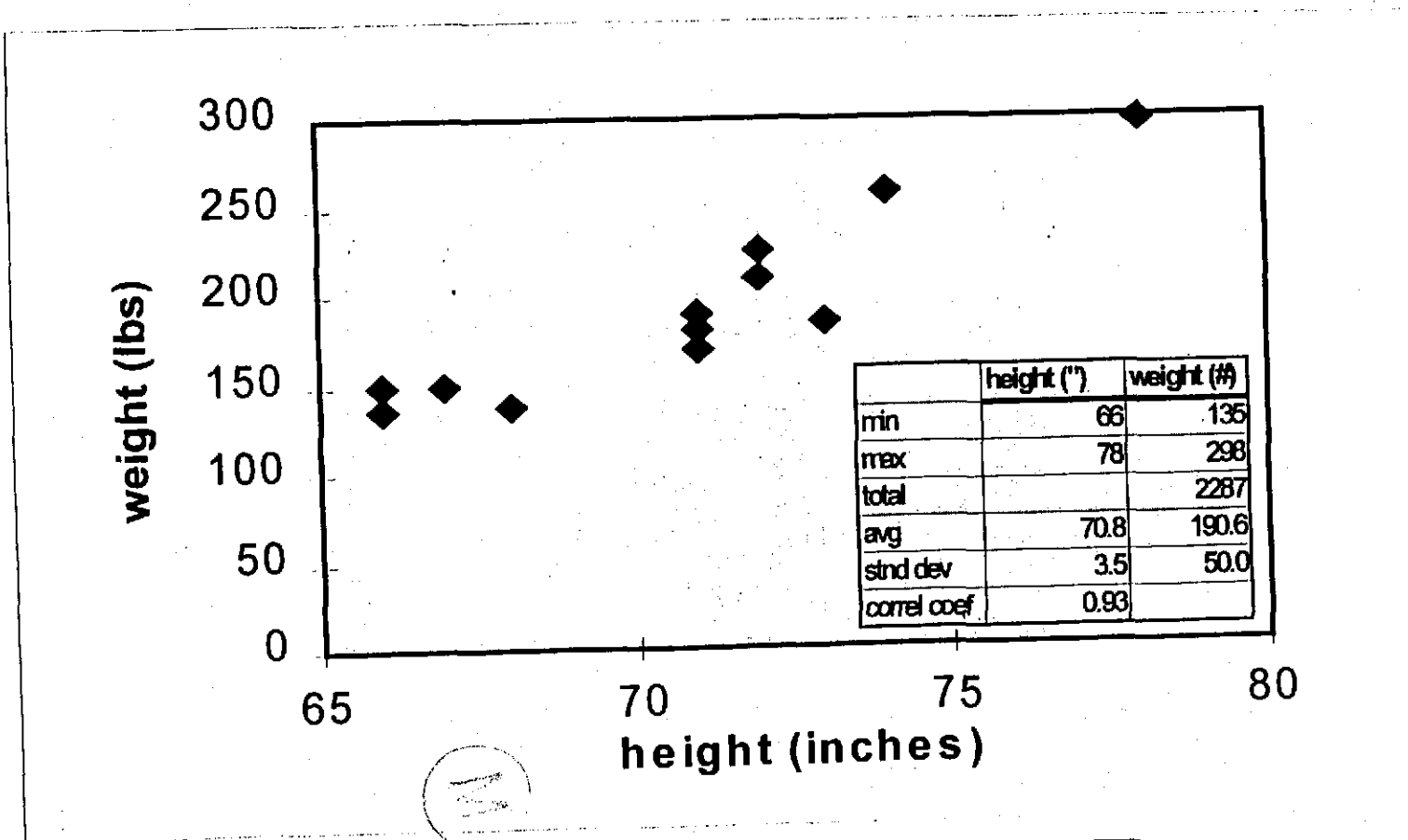



Example (2 of 2)

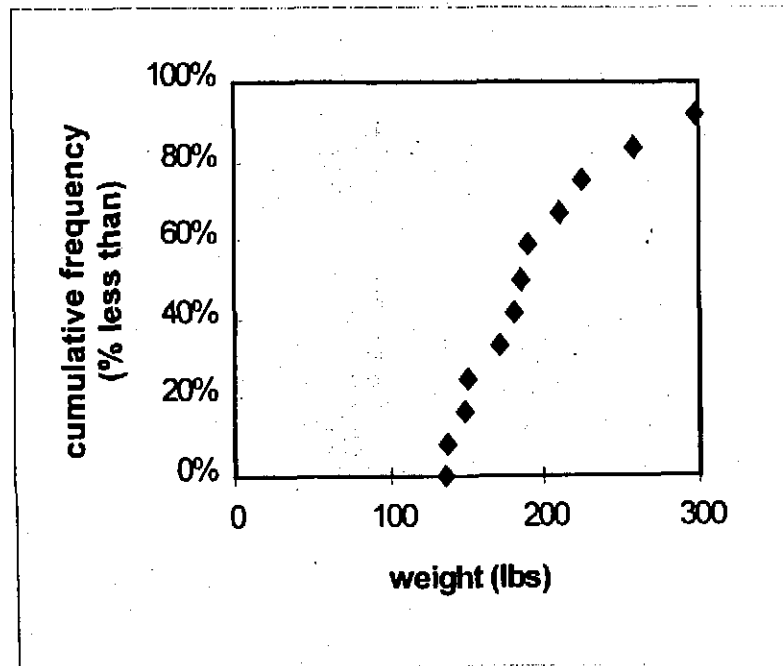
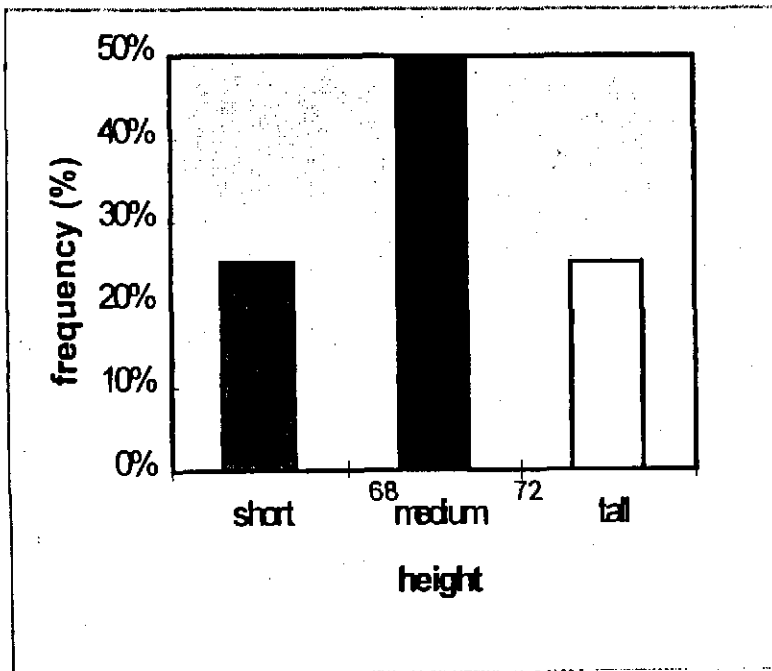

Statistical Variability

■ Spatial

- conditions vary with location or among individuals (z)

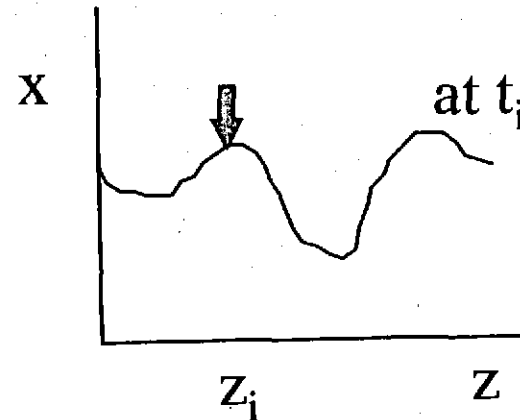

■ Temporal

- conditions change with time (t)
 - degradation (size)
 - stochastic (seismic loads)

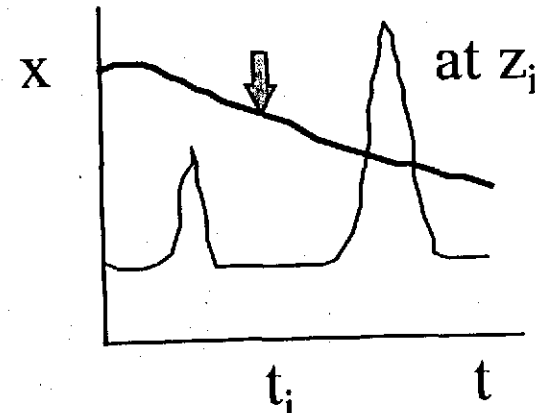

■ Descriptors

- individual or pairs of values
- average or extreme values



Statistical Correlation

- *Dependence* - relationship between parameters
 - variability in “dependent” parameter is reduced when considering subset with specific value of “independent” parameter
- *Independence* - no relationship between parameters
 - variability in parameter is not reduced when considering subset with specific value of other parameter
- Types of correlations
 - *inter-parameter* - among inputs, sensitivity, or error
 - *intra-parameter* - spatial or temporal autocorrelation



Parameter Assessment

■ *Measurement*

- practicality (quantity and representativeness)
- potential errors

■ *Inference*

- interpolation
- extrapolation
- decomposition (*model*: $x = f(y)$)
 - simplifications
 - similar problems at more detailed level

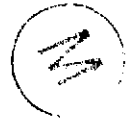

Uncertainty

- Parameter value(s) are not known with absolute certainty - various values are possible
- Uncertainty in parameter value is due to
 - imperfect information (*ignorance*)
 - stochastic/random process (*variability*)
- Uncertainty in parameter value can be quantified in terms of *probability distributions*
= relative likelihood of possible values

M



Types of Probability Distributions - binary parameter

probability $P[x]$
expresses relative
likelihood (from
 $0 = \text{impossible}$ to
 $1 = \text{guaranteed}$) of
binary parameter x

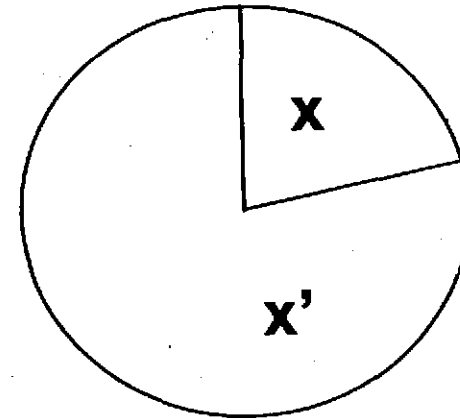

$$P[x] + P[x'] = 1$$



Types of Probability Distributions - discrete parameter (1 of 2)

*probability mass
function (pmf) $p[x]$*
expresses relative
likelihood (from
0 = impossible to
1 = guaranteed) of each
possible value of
discrete parameter x

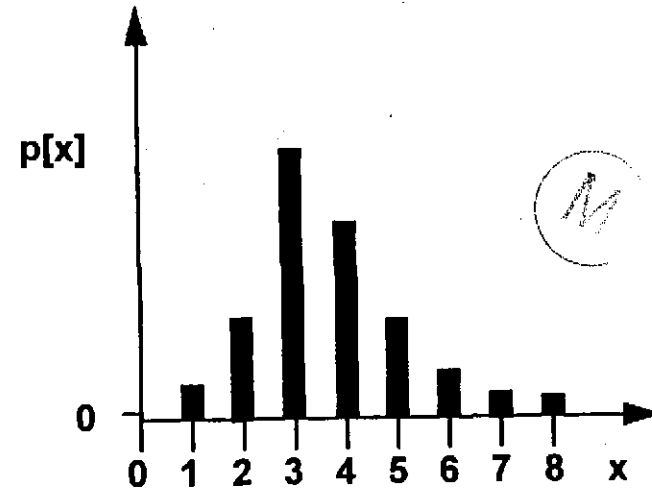

$$\sum_{\text{all } x} p[x] = 1.0$$



Types of Probability Distributions - discrete parameter (2 of 2)

if x are ordered,
*cumulative distribution
function (cdf) $P_{\leq}[x]$*
expresses relative
likelihood (from
 $0 = \text{impossible to}$
 $1 = \text{guaranteed}$) of being
equal to or less than
each possible value of
discrete parameter x

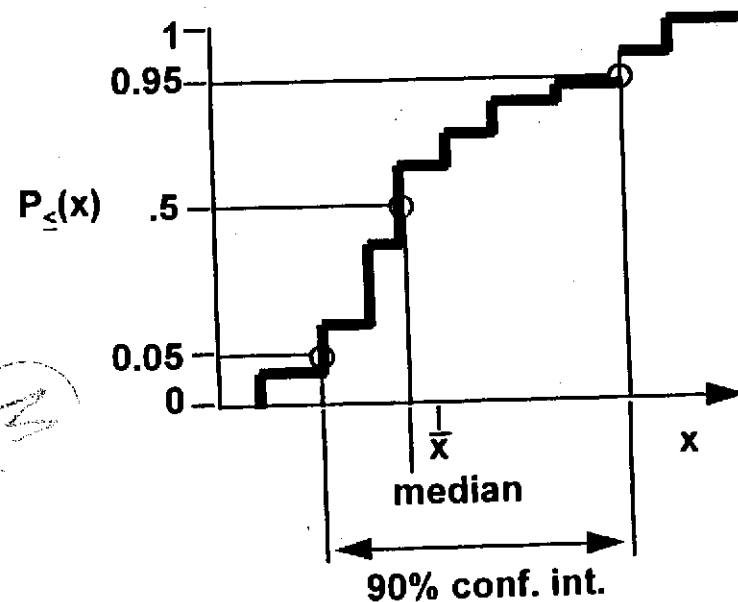

$$P_{\leq}[x] = \sum_{\text{all } x_i \leq x} P[x_i]$$





Types of Probability Distributions - continuous parameter (1 of 3)

probability density function (pdf) $p[x]$
expresses relative likelihood (from 0 = impossible to ∞ = guaranteed) of each possible value of continuous parameter x

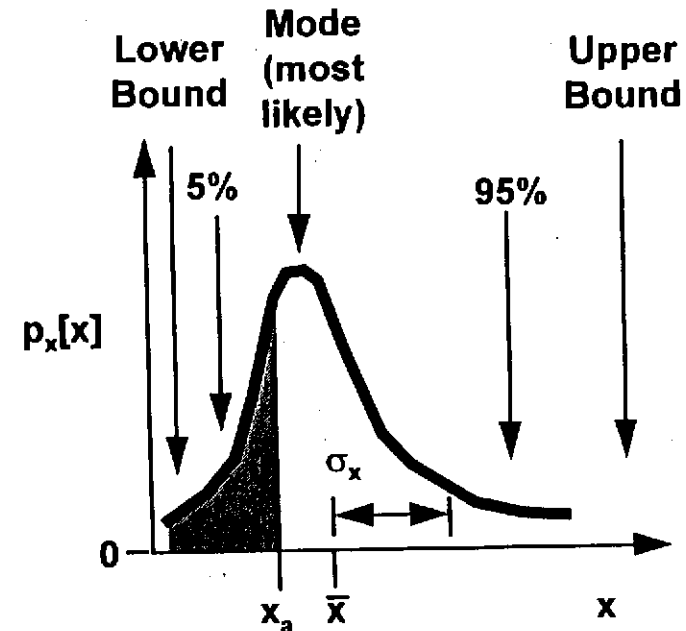

$$\int_{\text{all } x} p[x] dx = 1.0$$



Types of Probability Distributions - continuous parameter (2 of 3)

cumulative distribution function (cdf) $P_{\leq}[x]$
expresses relative likelihood (from 0 = impossible to 1 = guaranteed) of being equal to or less than each possible value of continuous parameter x

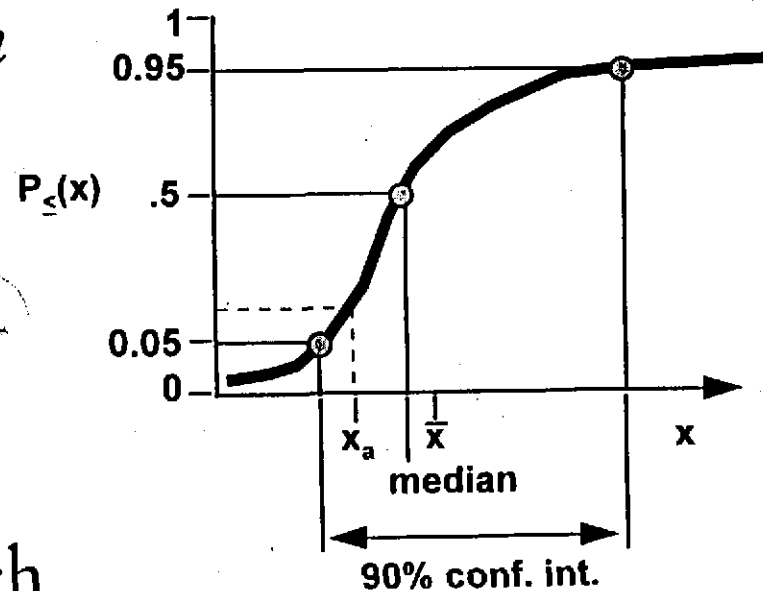

$$P_{\leq}[x] = \int_{\text{all } x_i \leq x} p[x_i] dx_i$$





Types of Probability Distributions - continuous parameter (3 of 3)

Convenient forms

- *uniform*
 - lower bound of x
 - upper bound of x
- *normal (Gaussian)*
 - mean of x
 - standard deviation of x
- *lognormal*
 - mean of $\ln x$
 - standard deviation of $\ln x$

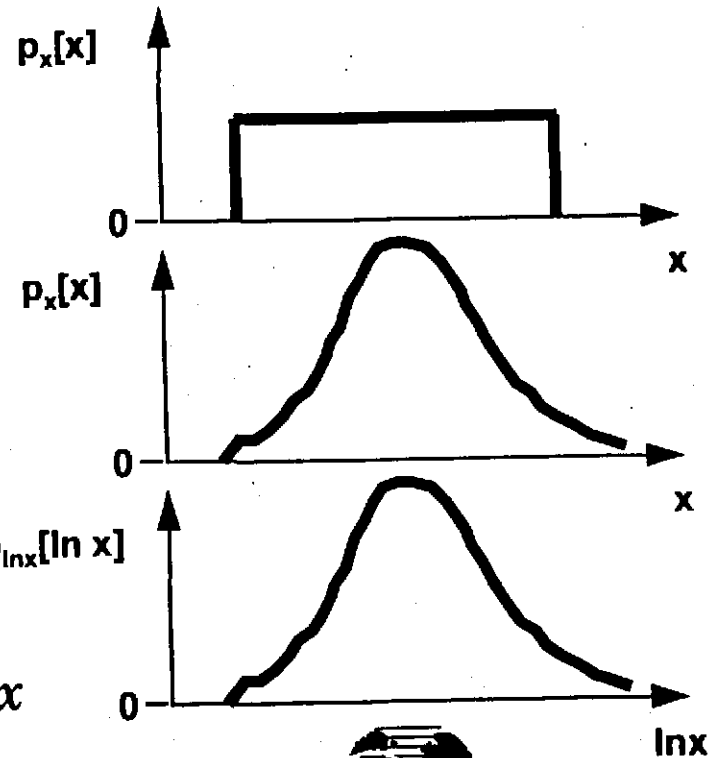

Types of Probability Distributions - population parameter

the characteristics x^* of population distribution x (e.g., mean, standard deviation, percentiles) can be considered continuous parameters, and the relative likelihood of any possible value of x^* expressed by *pdf* $p[x^*]$ or *cdf* $P_{\leq}[x^*]$

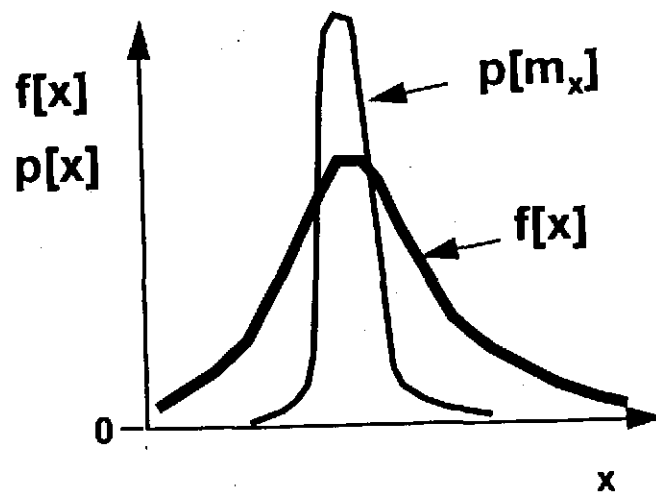

e.g., $p[x] = N[p[m_x], p[s_x]]$



Types of Probability Distributions - parameter combinations

- *joint probability distribution* $p[x,y]$ expresses relative likelihood of each possible combination of values of parameters x and y : $p[x,y] = p[x|y] p[y]$
- *conditional probability distribution* $p[x|y]$ expresses relative likelihood of each possible value of parameter x as a function of the value of parameter y (*assumption*): $p[x] = \sum_{\text{all } y} p[x|y] p[y]$
- *correlation* $s[x,y]$ expresses relationship between relative likelihoods of values of parameters x and y

Decomposition

■ Relationship

- parameter of interest = function of other parameters, which are more convenient to estimate

■ Graphical representation

- fault tree
- event tree
- probability tree
- influence diagram

■ Conceptual/analytical simplifications



Fault Tree

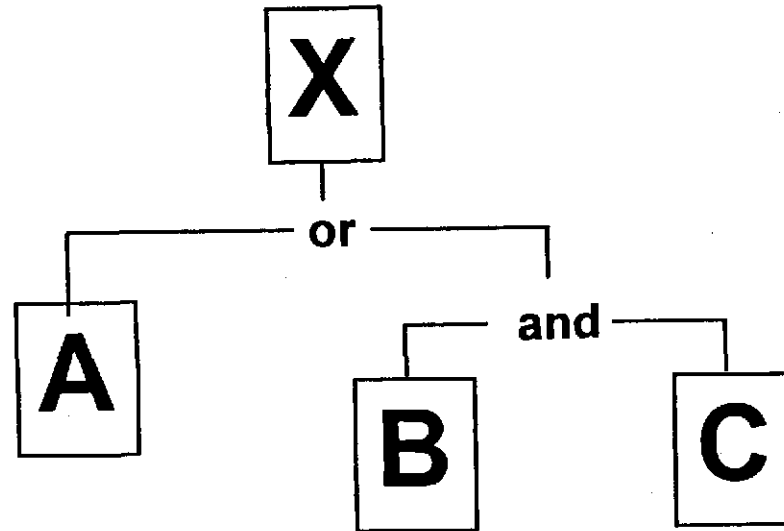

Event X will occur if either Event A or (Events B and C) occur

$$\begin{aligned} P[X] &= P[A] + P[B \text{ and } C|A'] \\ &= P[A] + P[A'] * P[B|A'] * P[C|B \text{ and } A'] \end{aligned}$$

$$\begin{aligned} \lambda[X] &= \lambda[A] + \lambda[B \text{ and } C] \\ &= \lambda[A] + \lambda[B] * P[C|B] \end{aligned}$$



Event/Probability Tree

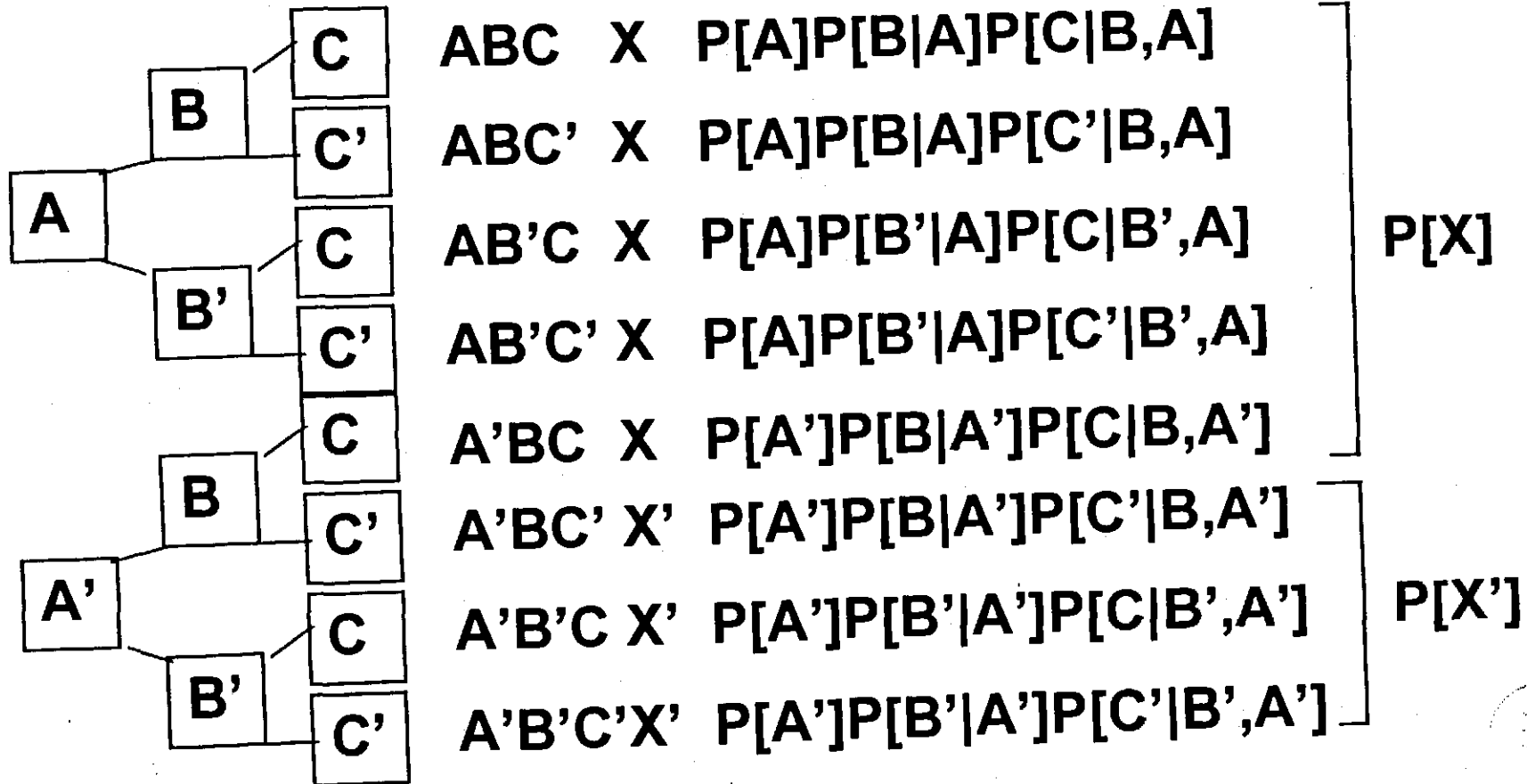



Influence Diagram

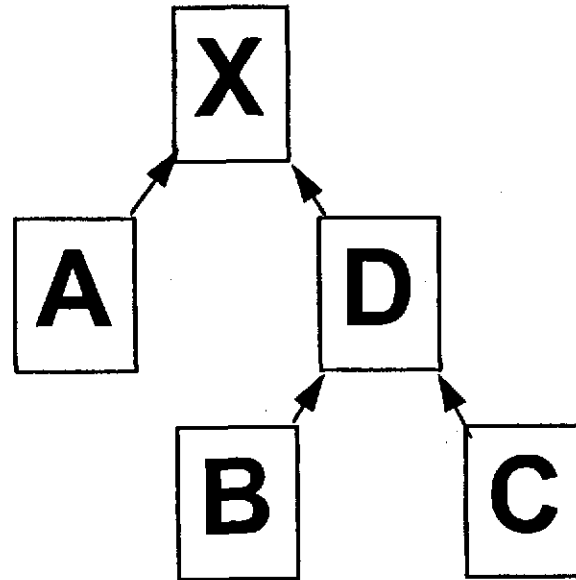

$$X = f\{A, D\}$$

$$D = f\{B, C\}$$

$$X = f\{A, B, C\}$$

$$p[X] = f\{p[A, B, C]\}$$

The parameters which influence X can be identified incrementally to any level of detail



Premise

*“Everything should be made as simple as possible
but no simpler.”*

Albert Einstein





Sources of Uncertainty

■ *Scenario*

- current conditions and ongoing processes
- future processes, events and decisions

■ *Models*

- conceptual simplifications
- numerical approximations

■ *Parameters*

- variability
- insufficient data





Decomposition Model

Input Parameters (x,y) Conditional Consequences (Z_s) Consequences (Z)

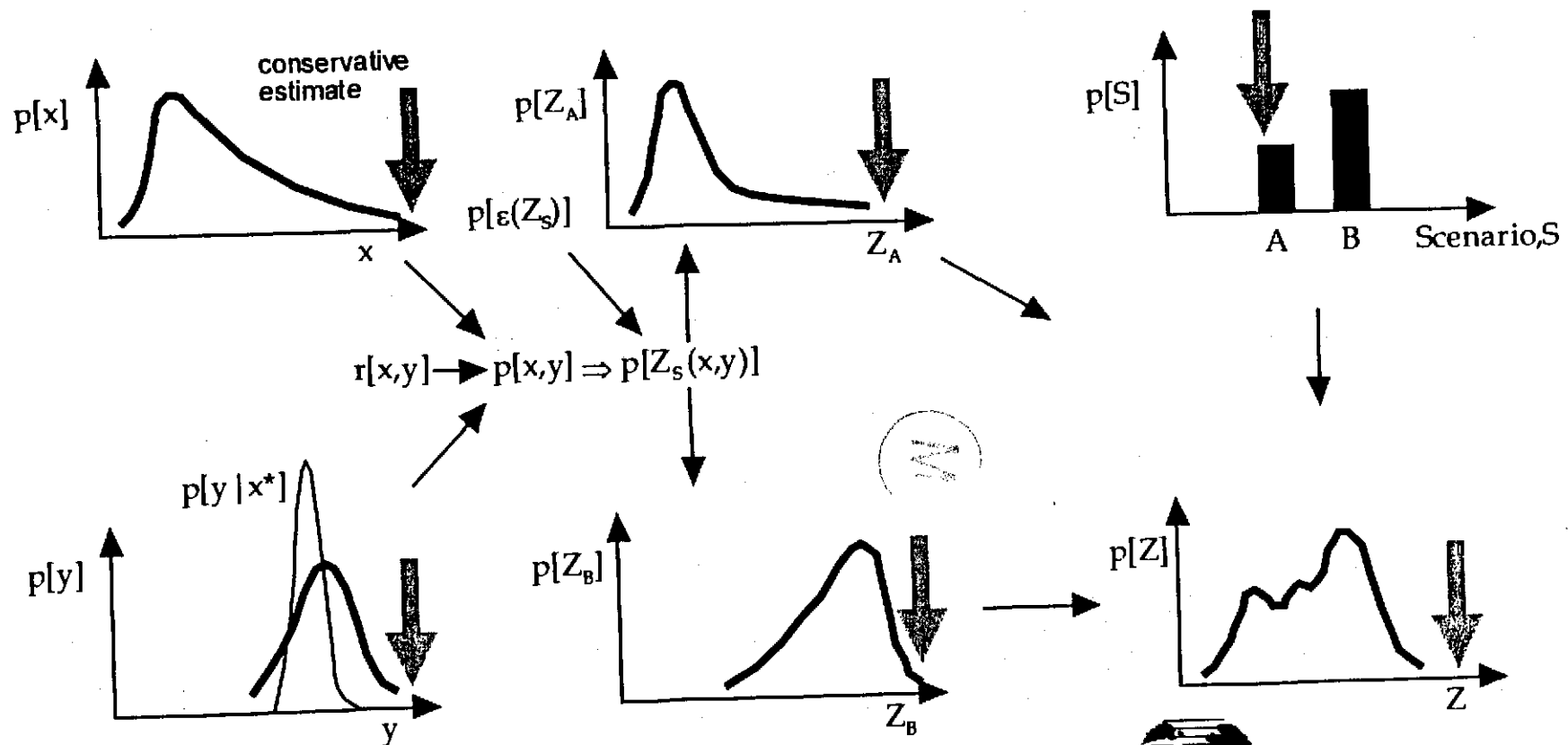



Modeling Techniques

■ *Analytical solutions/approximations*

- very complex (except for simple models) or many simplifying assumptions are required

■ *Event tree/fault tree/reliability analysis*

- failure expressed in terms of specific combinations of discrete events

■ *Monte Carlo simulation*

- many possible scenarios (parameter combinations/models) are generated randomly and evaluated, and the results are weighted by the likelihood of each of those scenarios
- proprietary to commercially available tools (spreadsheet addin)



@Risk Example

PR3 1930.301/63487.ppt





Spreadsheet Simulation

■ Uncertain system parameters:

- $X = \text{Normal distr w/ mean} = 10 \ \& \ \text{stnd dev} = 5$
- $Y = \text{Normal distr w/ mean} = 20 \ \& \ \text{stnd dev} = 5$

■ Possible assumptions (scenarios):

- A, additive ($Z = X + Y$) $P[A] = 0.25$
- B, multiplicative ($Z = X * Y$) $P[B] = 0.75$

■ Uncertain consequences:

$p[Z | A], p[Z | B], p[Z]$



Spreadsheet Model

Microsoft Excel - Book1

File Edit View Insert Format Tools Data Window Help

Arial 10

200%

	A	B	C	D	E
1	X	10	"=RiskNormal(10,5)"		
2	Y	20	"=RiskNormal(20,5)"		
3	S	0.75	"=RiskDiscrete({0, 1}, {0.25, 0.75})"		
4	Z A	30	"=B1+B2"		
5	Z B	200	"=B1*B2"		
6	Z	200	"=IF(B3=0,B4,B5)"		
7					
8					
9					

Sheet1 Sheet2 Sheet3 Sheet4 Sheet5 Sheet6

Ready



Simulation Model

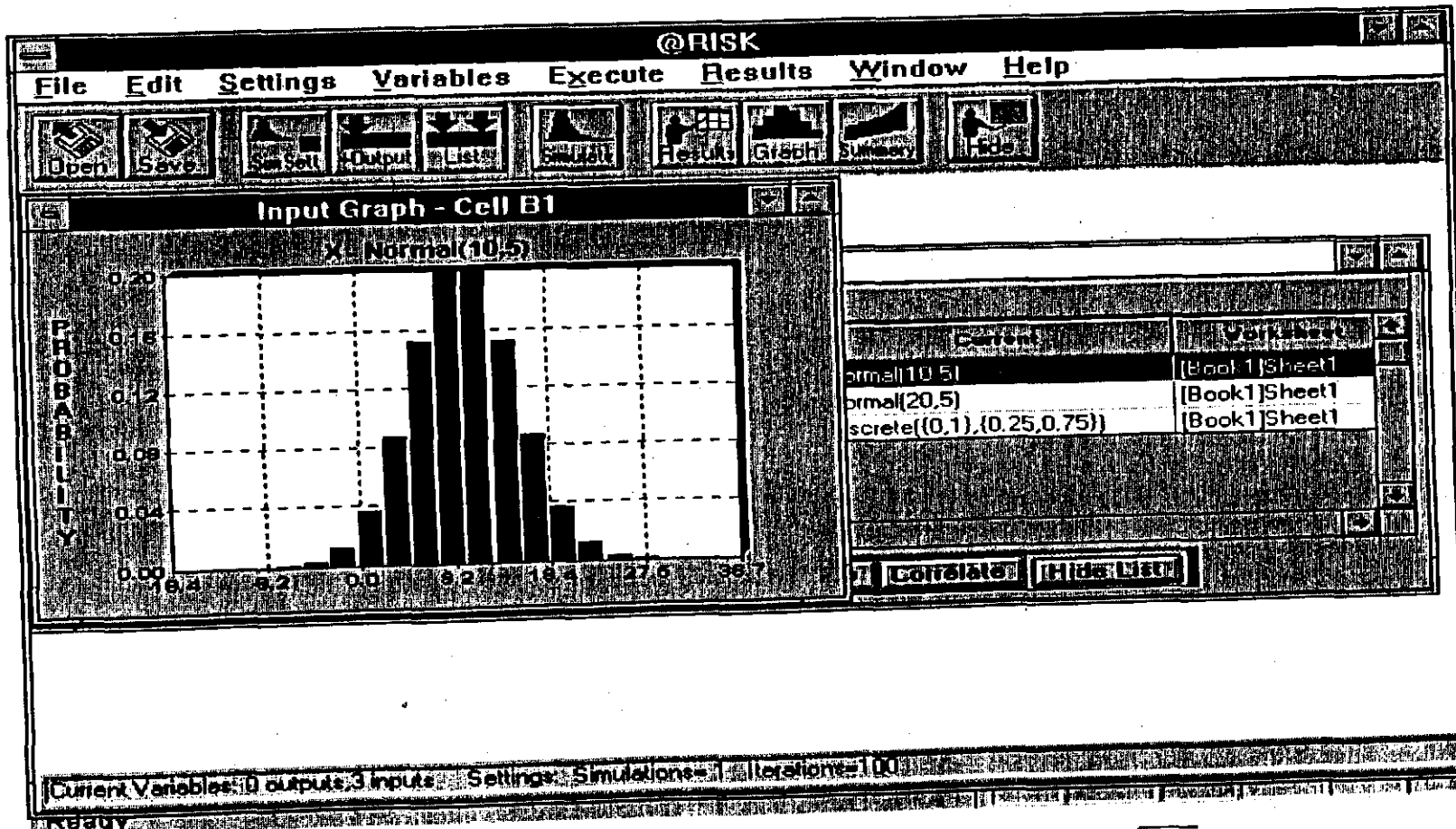



Simulation Settings

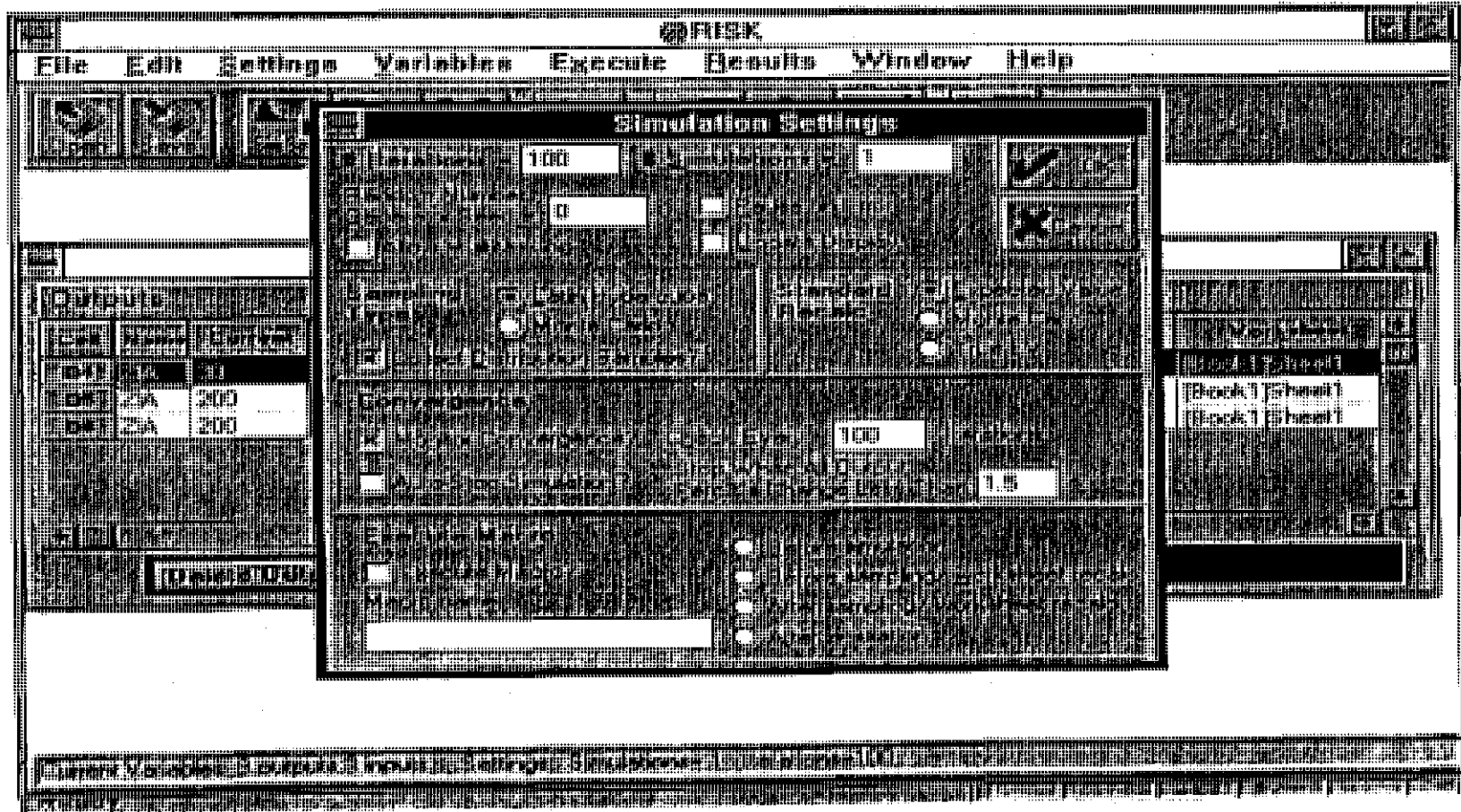

PR3 1930.301/63487.ppt



Information Only



Tabulated Results

Simulation Results

Iteration	Mean	Minimum	Maximum	Standard Deviation
04	214	122171	189.7679	579.879
05	214	122171	189.7679	579.879
06	214	122171	189.7679	579.879
07	Input 2	122171	189.7679	579.879

Simulation Statistics

Iteration	Mean	Minimum	Maximum	Standard Deviation
04	214	122171	189.7679	579.879
05	214	122171	189.7679	579.879
06	214	122171	189.7679	579.879
07	Input 2	122171	189.7679	579.879





Summary Graphical Results

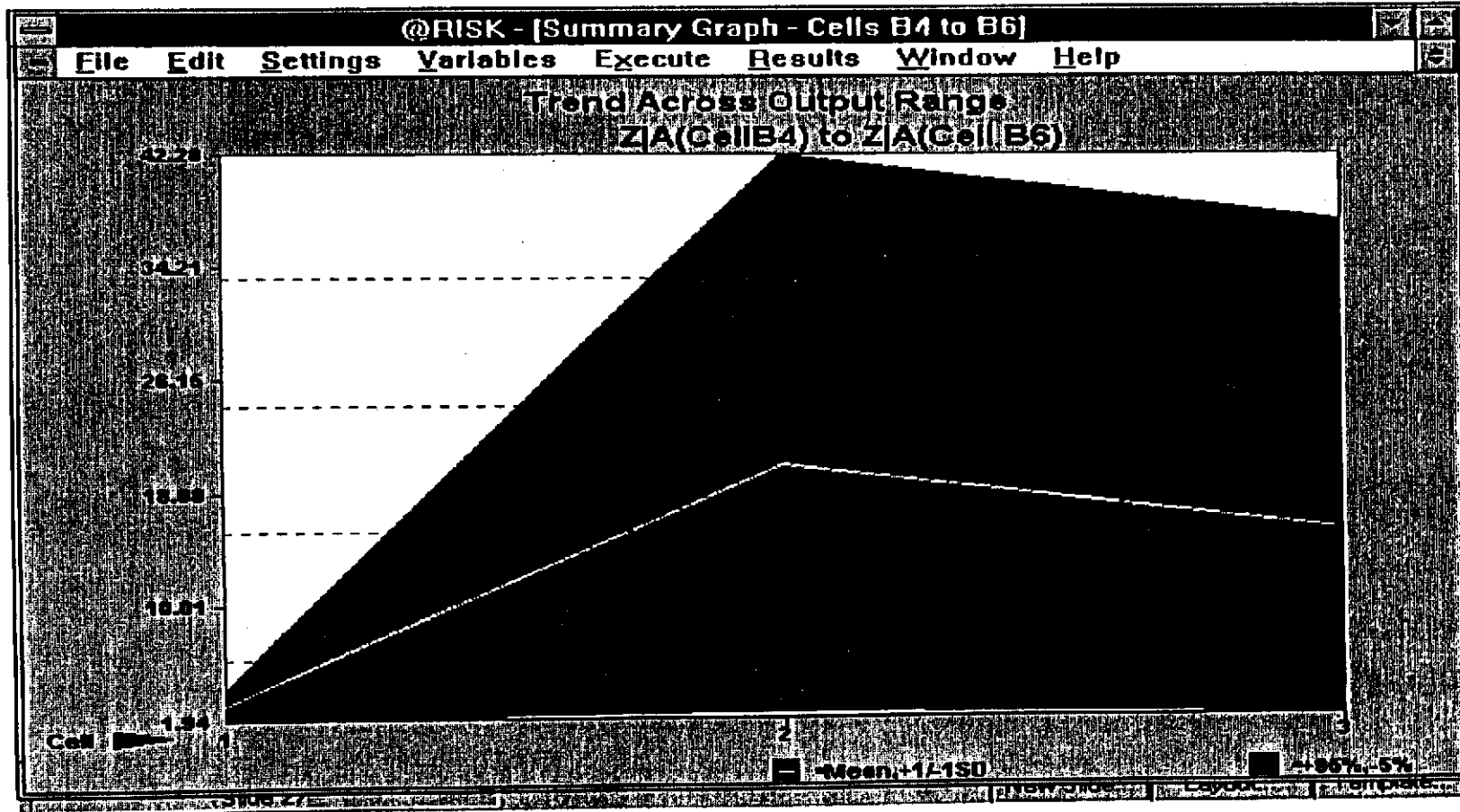

PR3 1930.301/63487.ppt



Information Only

Unconditional Results

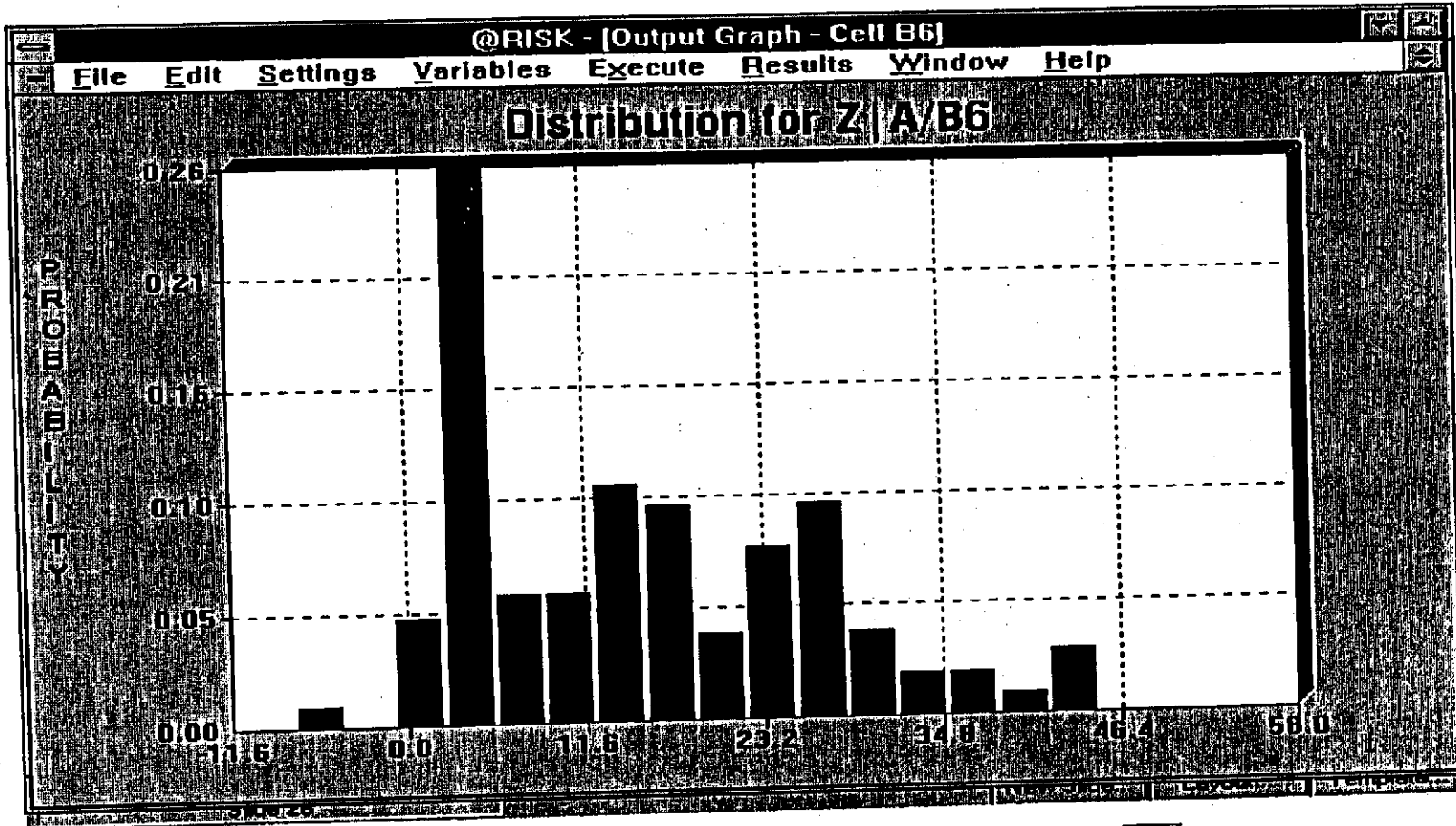



Sensitivity

@RISK

File Edit Settings Variables Execute Results Window Help

Open Save Run Set Output List Simulate Form Graph Summary Hide

Results

Output			Sensitivity to Input			
Cell	Name	Initial Value	Rank	Cell	Value	Rank
B4	Z1A	30	#1	B1	X	.6895446
B5	Z1A	200	#2	B3	S	.6707156
B6	Z1A	200	#3	B2	Y	.2443696

Statistics Data Sensitivity Scenarios

Current Variables: 3 Outputs: 3 Inputs: Settings: Simulations: Iterations: 100

M



Direct Assessments of Probability Distributions

■ *Objective*

- representative data set = > statistical analysis/model
- such data sets do not exist for some parameters

■ *Subjective*

- non-representative data set = > uncertainty based on judgment consistent with all available data (very commonly done implicitly)
- results are non-unique and may be controversial
- procedures are available to effectively mitigate potential problems and achieve consensus in defensible way

M



Subjective Assessment of Probability Distributions

■ *Almanac game* -

- assess specific confidence intervals for many parameters with known values (ref. almanac)
- example: assessor states an 80% confidence that the population of Indonesia in 1988 was between 50 and 150 million (true value is 177 m)
- percentage of parameters with true values in assessor's specified confidence interval should equal that confidence (e.g., half in 50% interval)

■ Assessors can be calibrated/corrected or trained to improve





Almanac Game Questionnaire #1

1. Berlin-Sydney air distance
2. French WWII battle fatalities
3. Vogue mag paid circulation
(avg 7/1/87-12/31/87)
4. Isle of Man population
(12/31/86)
5. Pope Gregory IX reign
duration
6. Canada's 1987 crude
petroleum production
7. Straight-line airplane speed
record (12/31/87)
8. Francis Bacon year of death
9. Sun-Neptune mean distance
10. Ecuador area (12/31/87)

Number of actuals:

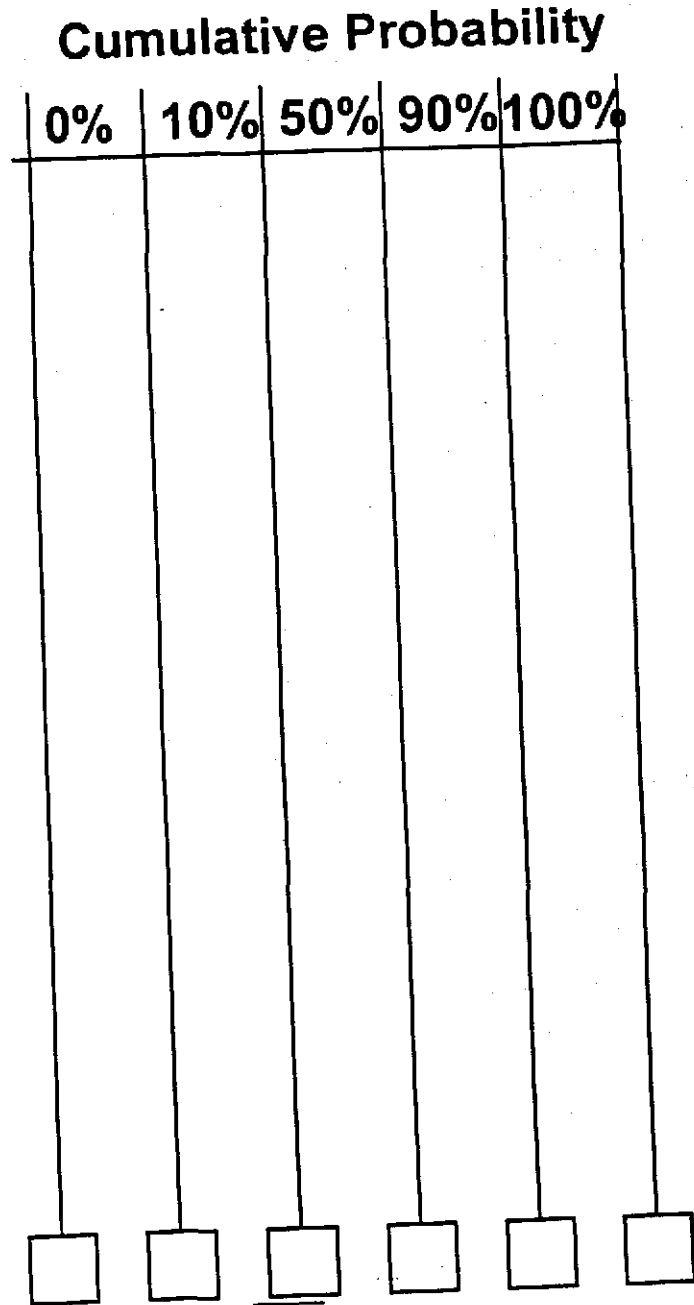

M



**Golder
Associates**



Potential Problems with Subjective Assessments (1 of 2)

■ Poor problem structure

- ambiguous parameter definition (random or average or percentile values, correlations)
- unspecified assumptions (conditional)
- incomplete knowledge of available information

■ Poor quantification

- inaccuracies
- imprecision (fuzziness)

■ Large uncertainties





Potential Problems with Subjective Assessments (2 of 2)

■ Poor defensibility

- inadequate qualifications of assessor(s)
- inadequate documentation

■ Group problems

- lack of commonality on problem structure
- disagreements or differences of opinion
- group dynamics

■ Uncorrected individual assessment biases

- *motivational* - statements inconsistent with beliefs
- *cognitive* - beliefs inconsistent with information



Motivational Biases

- *Management* - what they want to hear
- *Expert* - appear knowledgeable
- *Conflict* - self-serving
- *Conservative* - err on the “safe” side
- *Peer pressure* - go with the crowd





Cognitive Biases

- *Anchoring* - focus on starting point
- *Overconfidence* - ignore unlikely possibilities
- *Coherence/Conjunctive Distortions* - ignore components (combinations: e.g., $P[x] = \prod_y P[y]$)
- *Availability* - focus on easily recalled information
- *Base Rate* - focus on most specific information
- *Representativeness* - ignore relevance of different types of information (treat all equally)



7#2





Almanac Game Questionnaire #2



Cumulative Probability

	0%	10%	50%	90%	100%
1. Istanbul-Hong Kong air distance					
2. Romanians WWI battle fatalities					
3. Chicago Tribune paid circulation (M-F avg 12/87)					
4. Poland population (12/31/86)					
5. Number of baptized Roman Catholics (12/31/87)					
6. China's 1987 crude petroleum production					
7. World ranking of SeaTac airport (1987 passengers)					
8. Year of first manned balloon flight					
9. Diameter of Neptune					
10. Poland area (12/31/87)					
<i>Number of actuals:</i>	<input type="checkbox"/>	<input type="checkbox"/>	<input type="checkbox"/>	<input type="checkbox"/>	<input type="checkbox"/>



**Golder
Associates**



Subjective Assessment by Expert Elicitation

- *Procedures* - ensure accurate and defensible probability distributions, based on judgment of expert(s) consistent with all available information, by mitigating potential problems to extent possible
- *Elicitation* - explicit interaction between
 - *elicitor* - understands probability, elicitation, and parameter definitions/model
 - *technical expert(s)* - most familiar with all available information and best qualified/unbiased to interpret that information (less *ignorance*)

W



Variables of Expert Elicitation Process

- Number and credibility of experts
 - representative sample of technical community
- Interaction and consensus among experts (if more than one)
- Outside participation and review
- Information collection and review
- Elicitation techniques, detail and precision
- Defensibility and documentation





Expert Elicitation Process

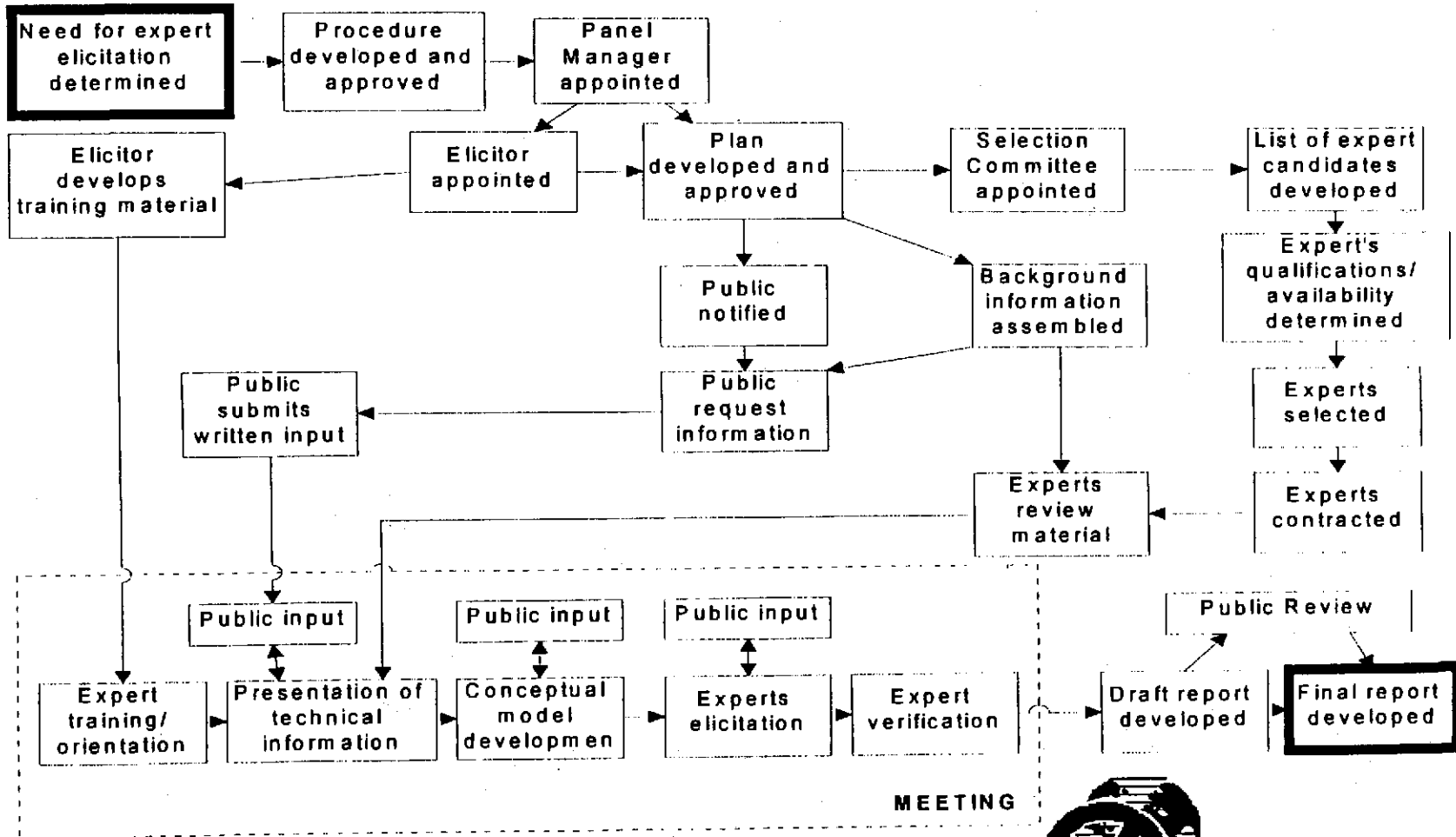



Expert Elicitation Materials

Activity

- 3.1. Definition of technical issue(s)
- 3.2. Public Notification
- 3.3. Selection and contracting of experts

- 3.4. General orientation and elicitation training

- 3.5. Presentation and review of issue(s)
- 3.6. Preparation of expert analysis by elicitor
- 3.7. Discussion of analysis by panel members
- 3.8. Elicitation
- 3.9. Recomposition
- 3.10. Review and approved or dissenting opinions provided by the experts
- 3.11. Documentation of the Process and Results

Materials

- CAO Procedure/Plan
- Letter to Stakeholders; media release
- Selection forms signed by Selection Committee; resumes, OCI, contracts signed by each expert
- Transcript; background reading materials; OHs; form signed by each expert
- Transcript
- Spreadsheet; OHs
- Transcript
- Transcript; written summary
- Spreadsheet; OHs
- Transcript; statements signed by each expert

- Report; review comments; statements signed by each expert regarding comment resolution



General Expert Elicitation Procedures (1 of 2)

1. *Conditioning* - expert(s) are trained in probability and review available information
2. *Structuring* - parameters to be assessed are clearly defined (including any assumptions or decomposition/recomposition per the model)
3. *Elicitation* - depending on parameter type, the universe of possible parameter values is identified, and then the probability distribution for parameter values is quantified by the experts through questioning by the elicitor

General Expert Elicitation Procedures (2 of 2)

3. *Elicitation* (cont.) - elicitor looks for and mitigates any assessment biases and ensures consistency and logical rationale in the assessments; if more than one expert, elicitor looks for and mitigates adverse group dynamics, ensures commonality in problem structure, and identifies and attempts to resolve other differences amongst experts (or aggregates)
4. *Verification/Documentation* - probability distributions are restated by elicitor and confirmed/modified by expert(s), and the entire process is documented

PR3 1930.301/63487.ppt



➤ Specific Elicitation Topics

1. *bounding values* (minimum and maximum)
2. *cumulative probability of specific values*
convergent pair-wise comparisons (e.g., is $x < 4$ more likely than event y with known probability?)
3. *specific percentile values*
 - direct assessments (e.g., almanac game)
 - convergent pair-wise comparisons of confidence intervals (e.g., is $x < 4$ more likely than $x > 4$?)
4. *most likely value*
5. *distribution form*
(symmetry and modality)





Probability Wheel

Choose A or B as most likely

A = {spin wheel and
land in target area}

B = { $X < 4$ }

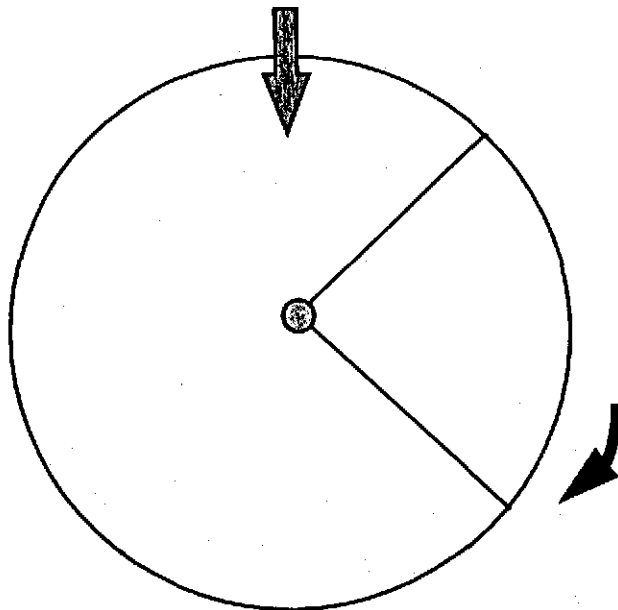

Adjust size of target area
(or value of X)
until indifferent to choice

Intervals

- to define *50 percentile value*

choose between A and B as most likely

$$A = \{X < 4\} \quad B = \{X > 4\}$$

adjust threshold value until indifferent to choice

- to define *33 and 67 percentile values*

choose between A, B and C as most likely

$$A = \{X < 3\} \quad B = \{3 < X < 6\} \quad C = \{X > 6\}$$

adjust threshold values until indifferent to choice



Integrated Construction of Probability Distribution

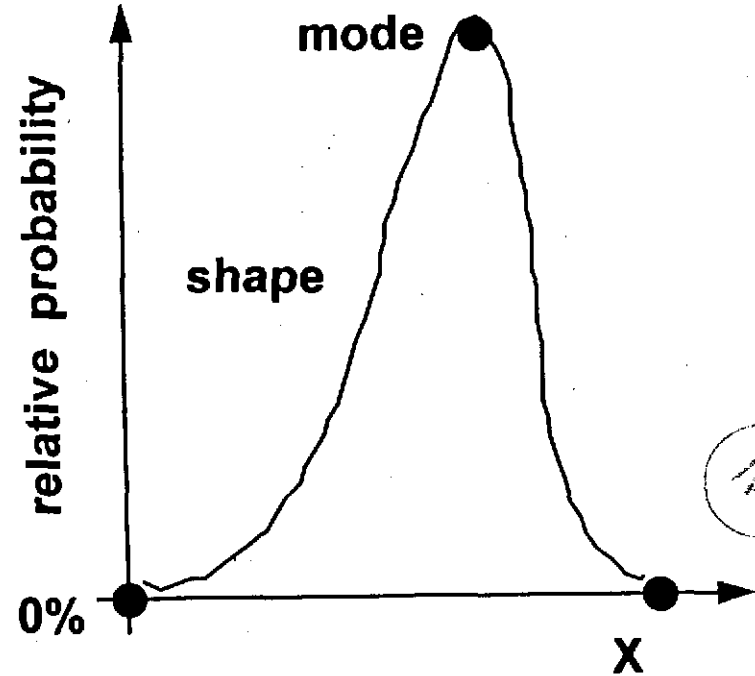
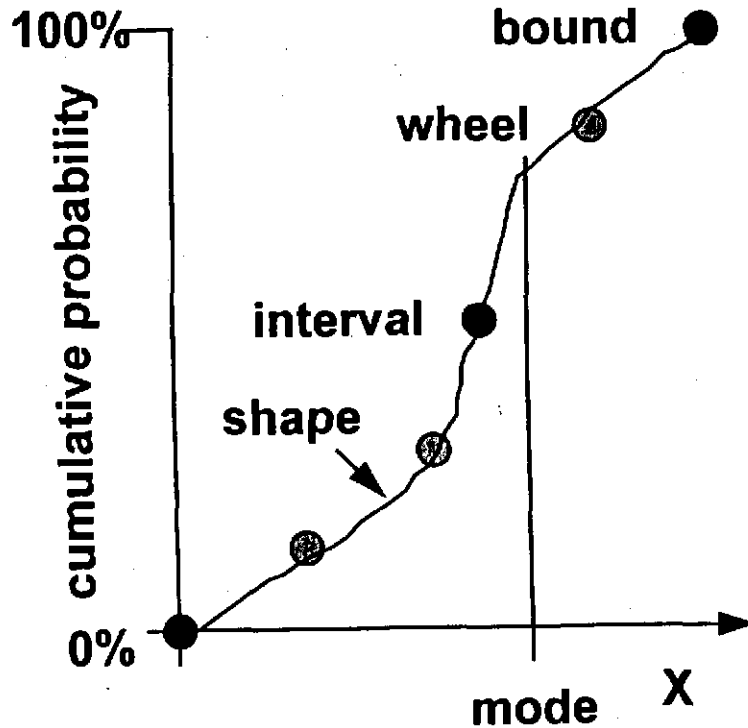



Discrete Distribution View

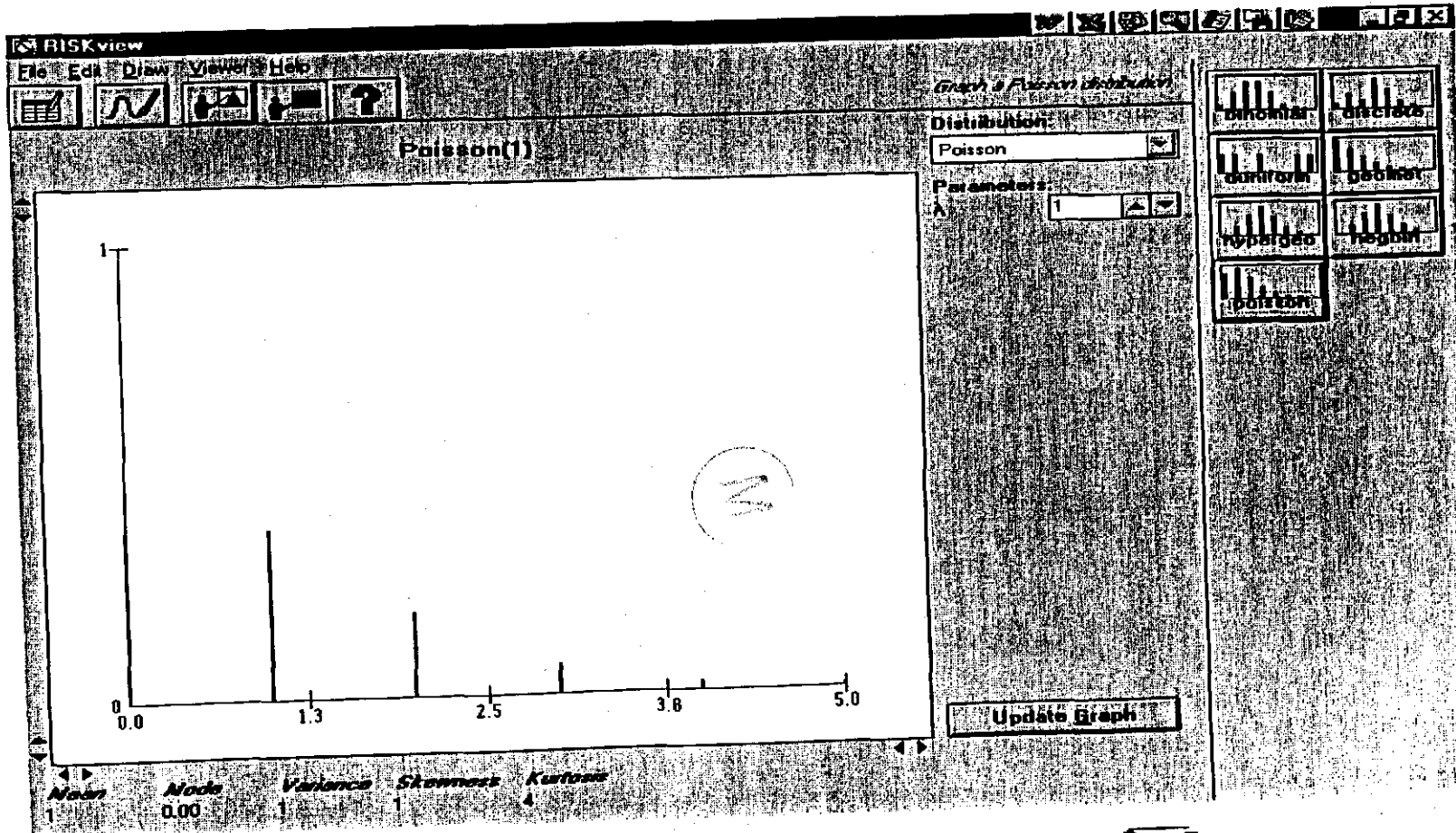



Continuous Distribution View

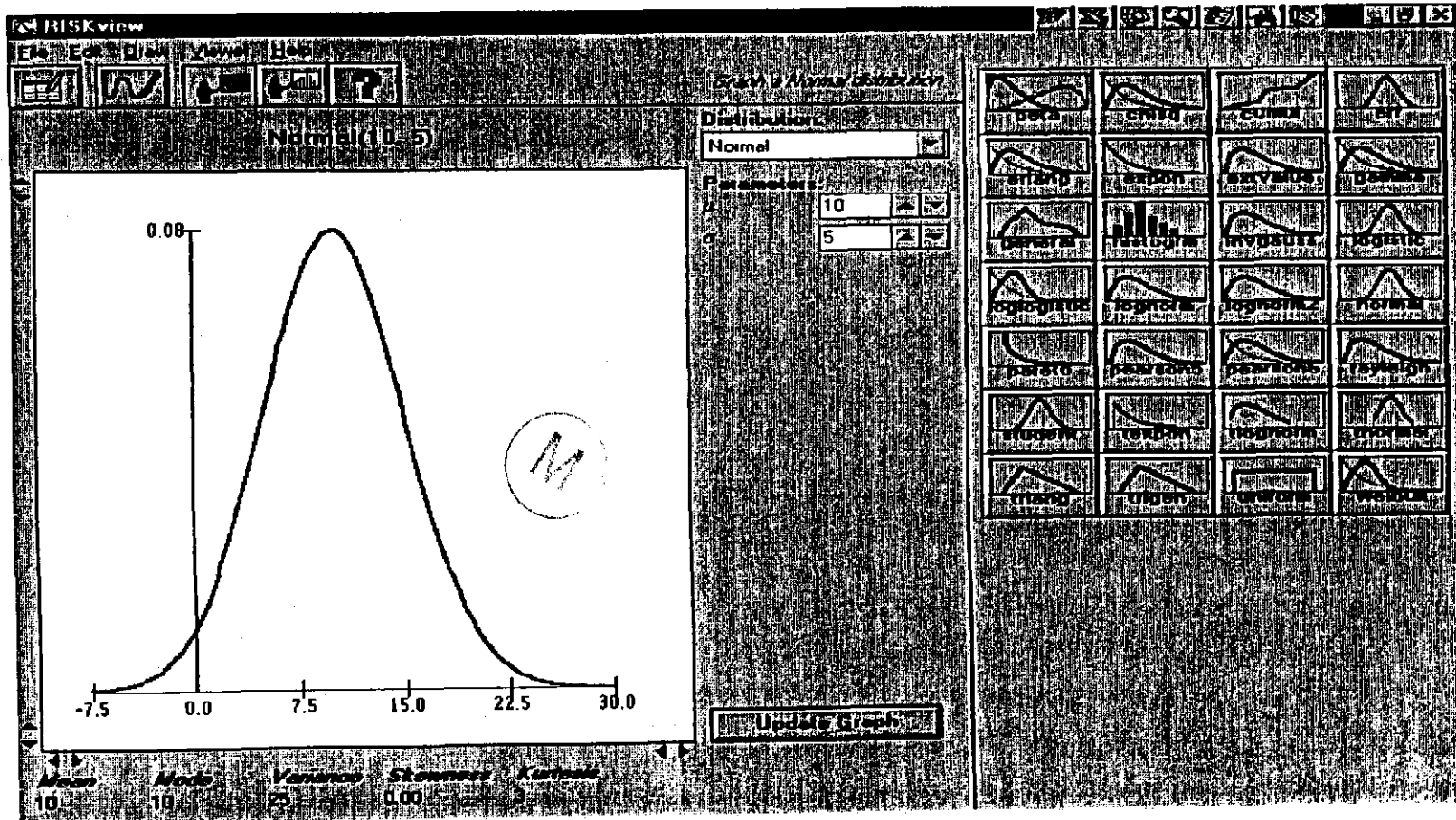

PR3 1930.301/63487.ppt





Cumulative Distribution View

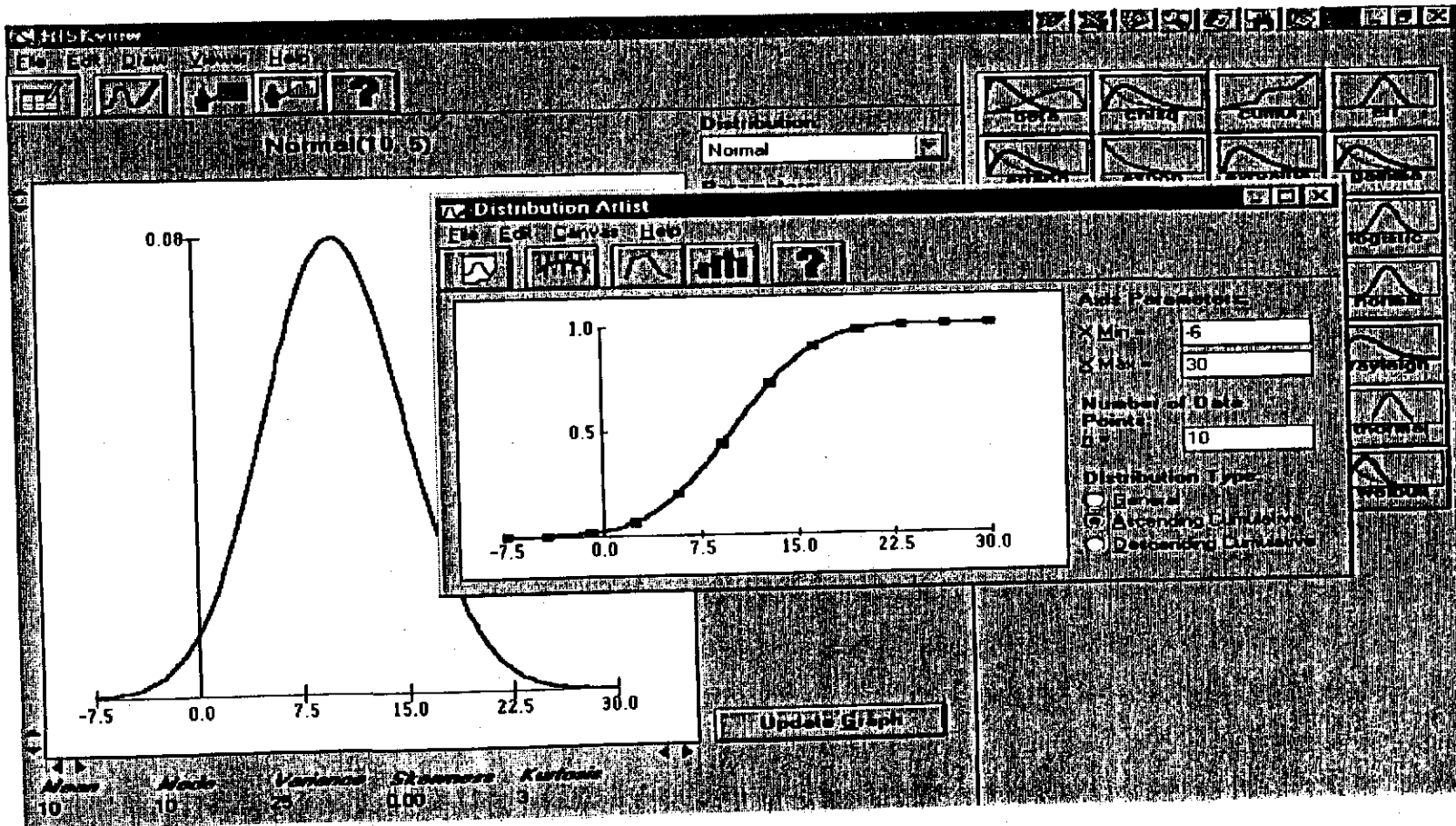



Modified Cumulative Distribution

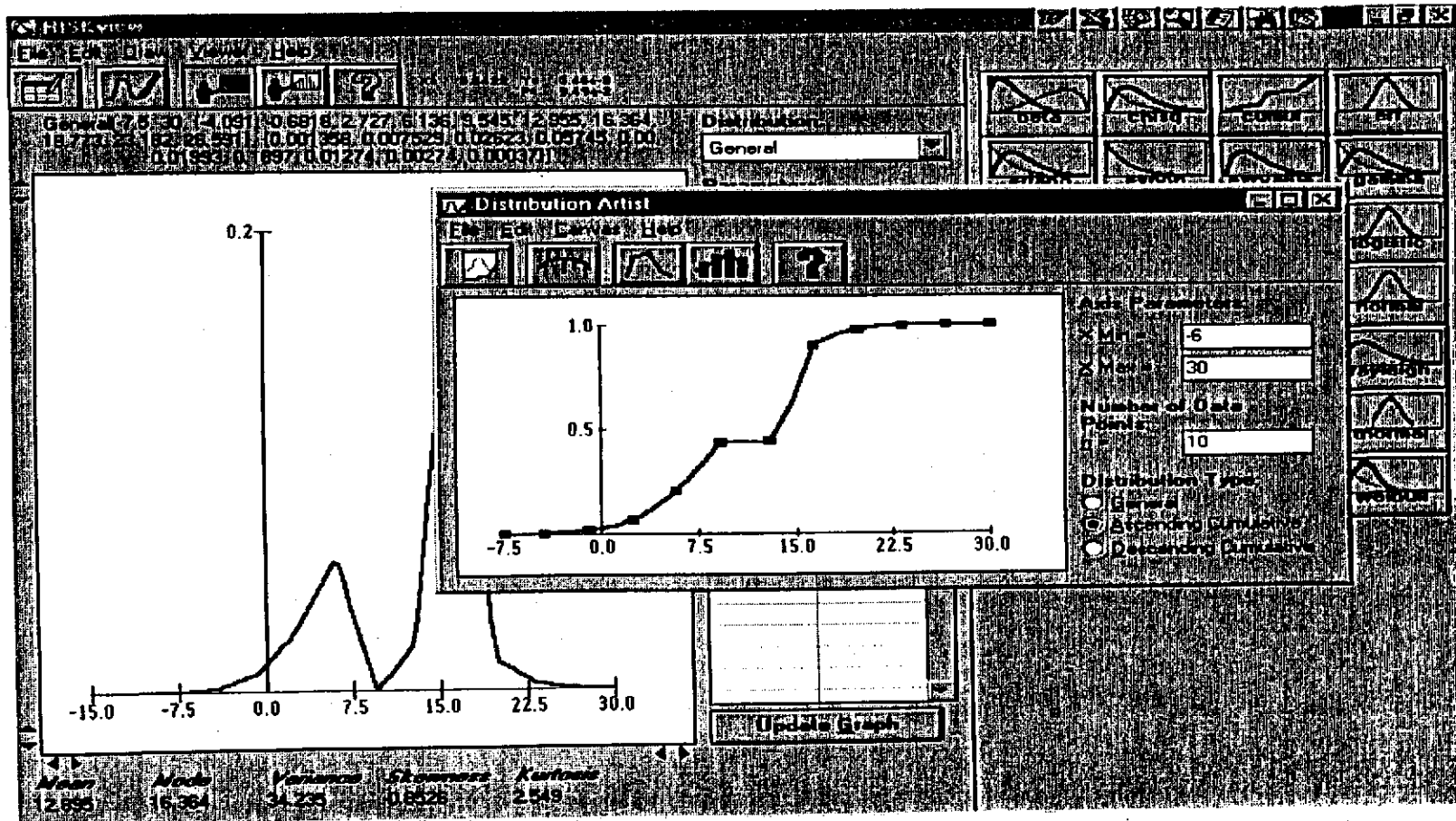

PR3 1930.301/83487.ppt





Modified Density Distribution

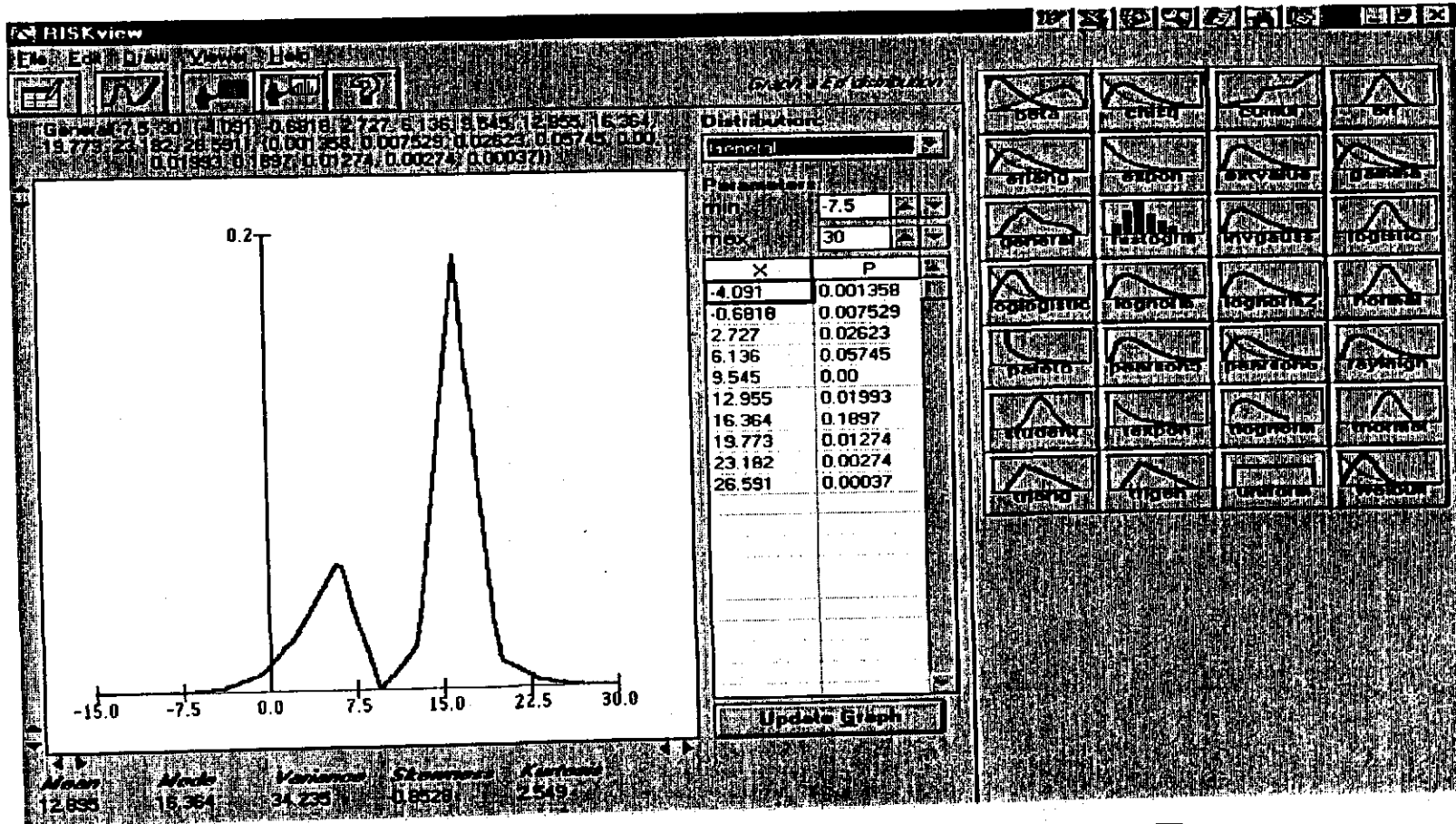

PR3 1930.301/63487.ppt



Information Only



Distribution(s) Fit to "Data"

BestFit

File Edit View Options Graph Statistics Window Help

File Edit View Options Graph Statistics Window Help

BestFit

Rank/Distribution

1. Uniform
2. Beta
3. Weibull
4. Normal
5. Gamma
6. Rayleigh
7. Chisq
8. Logistic
9. ExtremeValue
10. Expon

Display
 Histogram
 Probability
 PDF
 CDF
 Q-Q Plot
 P-P Plot
 Residuals

OK Cancel

Statistics UNITS

Rank/Distribution	Chi-Square	Kolmogorov-Smirnov
1. Uniform	1.232595e-31	0.0
2. Beta	6.134941e-5	2.144904e-3
3. Normal	0.225855	0.081521
4. Weibull	0.217622	0.081521

Uniform 1

Comparison of Input Distribution and Uniform(5.00,10.00)

0.11
0.05
0.00

0 2 4 6 8 10

■ Input
■ Uniform

Parameter 1	Uniform	Beta	Normal
Parameter 1	0.0	0.985149	5.0
Parameter 2	10.0	0.985149	2.901149
Parameter 3			
Formula	Uniform(5.00,10.00)	Beta(0.99,0.99) * 10.00	Normal(5.00,2.90)
Minimum	0.0		
Maximum	10.0	10.0	
Mean	5.0	5.0	5.0
Mode	0.0	0.0	5.0
Median	5.0	5.0	5.0



Conclusions

- Due to *variability* (irreducible) and/or *ignorance* (imperfect information), there is uncertainty in specific parameter values
- Uncertainty can be quantified in terms of a *probability distribution*, which expresses the relative likelihood of any possible value
- Probability distributions can be defensibly assessed based on the elicited judgment of qualified and unbiased technical expert(s), consistent with available information and minimal assumptions

APPENDIX B
DECOMPOSITION MODEL

Best Copy Available

Information Only

Appendix B Decomposition Model

The decomposition model is discussed in Section 4 of the report. As discussed, the decomposition model produces a complementary cumulative frequency distribution (CCDF) for the population of particle sizes that will exist at the time of an inadvertent human intrusion, as a function of the predicted conditions in the repository at that time. In other words, the particle size distribution depends on the repository conditions, as specified by performance assessment (PA). These inputs are uncertain, and this uncertainty must be propagated through the decomposition model in order to determine the uncertainty in particle size populations. PA thus provides some of the inputs required for the decomposition model, so that the decomposition model must be linked to PA (either directly or indirectly). However, the implementation of the decomposition model in PA is outside the scope of this elicitation.

The various concepts and algorithms, as discussed in Section 4, have been incorporated in the attached EXCEL 5.0 spreadsheet (WP_DIA4.xls). This implementation of the model is discussed below, in terms of input requirements, calculations, and types of results.

B.1 Inputs

B.1.1 Parameters

Various input parameters are required for the decomposition model. These parameters can be divided into: 1) *waste characteristics*, which the panel assessed; and 2) *repository conditions*, which are predicted by performance assessment for the time of interest. These two categories include the following input parameters.

- *initial waste characteristics:*

- The assessed amounts and particle size distributions for each of the six waste groups prior to any degradation (corrosion, biodegradation, or dissolution) or aggregation (cementation or encapsulation) processes, at a random areal location at the appropriate scale and vertical location within the repository room for inadvertent intrusion. The amounts of each waste group can be expressed directly, or in terms of more detailed waste types and the group to which they belong. The particle size distribution is expressed in terms of minimum and maximum values, and a two-piece linear power law for the cumulative frequency of particle sizes. Currently, although there is a place to express the critical scale and variability/uncertainty ratio for each material group from which the scale dependence of the properties can be determined, only the large scale average properties are used. Alternatively, possible sets of waste mixes, and their frequency and scale of occurrence, can be expressed in terms of the percent (by volume) of each of the six material groups.
- The general characteristics of the waste degradation byproducts and dissolved constituents (including salt in brine), as well as the general effect of cementation on particle size. This includes the percent amount of degradation or dissolved products (if any) from each material group that will precipitate out as free particulates (as opposed to cementation agents) when there is large available waste porosity, and the population distribution of the size of such free particles (in terms of a two-piece linear power law for the cumulative frequency of particle sizes). This also includes the effect of cementation on particle size, in terms of the amount of cementation

(relative to the available porosity) required to totally aggregate all particles into a single particle.

- *future repository conditions:*

- The amount (in terms of both the percent of material remaining and the average depth removed from every surface, which is equal to the change in radius of an equivalent spherical particle) of each reduction process at the time and location of intrusion, including:
 - corrosion of iron- and aluminum-base metals,
 - biodegradation of cellulose and solidified organics,
 - biodegradation of rubber and plastics, and
 - dissolution of MgO.
- *porosity* of the waste available for cementation;
- *precipitation* of dissolved salt from the brine (due to corrosion and MgO dissolution), either as free particulates or as cementing agents (in terms of the percent of the initial waste); and
- *encapsulation* of waste by creeping salt (in terms of the percent of the waste volume).



B.1.2 PA Linkage

The repository conditions, as listed above, are predicted by PA as a function of time. However, at any time in the future, they are highly uncertain, but are correlated. PA quantifies these uncertainties through Monte Carlo simulation. The decomposition model could be linked to the PA codes so that the particle size distribution at the appropriate time of inadvertent intrusion would be simulated during each realization. This could be done either by: dynamically linking the spreadsheet to the PA code; by re-coding the spreadsheet as an add-on module to the PA code; or by developing a "response surface" (i.e., either an analytical approximation or interpolation from lookup tables for the results as a function of the input parameters), which is incorporated in the code. The uncertainty in the particle size distribution would then be determined from the large number of realizations generated in such a way. It should be noted, however, that development of an adequate response surface may be difficult, given the relatively large number of input parameter and output parameters.

If it is not feasible to link the decomposition model directly to the PA codes (e.g., because PA recalculation or PA code modification entail significant cost and/or time), then the results of the PA can be expressed in terms of joint probability distributions for the various repository conditions, or simply the set of simulated repository conditions for each realization. In either case, the repository conditions can then be randomly sampled during Monte Carlo simulation as input to the decomposition model. This simply requires that a Monte Carlo simulation tool (e.g., @RISK, which is commercially available) be added onto the spreadsheet, which would be relatively easy to accomplish.

In either case, the uncertainty in the particle size distribution at the time of inadvertent intrusion would be determined as a function of the uncertainty in repository conditions at that time. This uncertainty could be expressed as a probability distribution for specific population characteristics (e.g., average or ten percentile values), or as a set of equally likely populations.

It should be noted that the implementation of the decomposition model in PA is outside the scope of this elicitation.

B.2 Calculations

B.2.1 Modeling Steps

The various input parameters are used to generate the results of interest, using the algorithms presented in Section 4 of the report. Specifically, these include the following steps:

1. The initial waste characteristics (as assessed by the expert panel) are specified in sheet "WP_size":
 - The initial large scale average amounts (W_{j0} , in percent by weight, although not necessarily adding to 100%), density (γ_j) and categories i (ij), where j is one of the following groups: 1) Fe- and Al-based metals, which are subject to corrosion; 2) non-iron metals/inorganics/vitrified/soils/cement/solid inorganics, which are relatively inert to reduction processes; 3) salt fragments, which are relatively inert to reduction processes; 4) cellulose/solid organics, which are subject to biodegradation; 5) rubber/plastics, which are subject to biodegradation; or 6) MgO backfill, which is subject to dissolution) of each of the detailed materials j , including iron-base metal/alloys, aluminum-base metal/alloys, other metal/alloys, other inorganic materials, vitrified cellulose, rubber, plastics, solidified inorganic materials, solidified organic material, cement (solidified), soils, steel packaging, plastics packaging, lead packaging, steel plugs, MgO backfill, and salt fragments (in cells B13:B30, D13:D30, and E13:E30, respectively). The weight percentages, which for the wastes and backfill add up to 100%, also include salt fragments from roof falls, which then sums to greater than 100% (this is dealt with in step 3). Alternatively, the relative amounts of each of the material groups (W_{i0}) in percent by weight could be input directly (in cells B35:B40 for large scale average and in cells C35:C40 for the specified scale and vertical location of interest), skipping step 3 below. Although the weight percentages are specifics, they are not currently used in determining particle size.
 - The initial amounts (W_{i0} in percent by volume) of each material group at the scale and location of interest is specified in cells H35:H40.
 - The initial average particle size distribution for each of the material groups ($CCF(v)_{i0}$, in terms of the complementary cumulative frequency (CCF) or percent of particles larger than a particular size). For each material group, this is expressed in terms of minimum and maximum particle sizes (in cells F35:F40 and G35:G40, respectively) and in terms of a piece-wise power law CCDF, where

$$CCF\{v\}_{i0} = \begin{cases} (X_{1i}/v)^{D_{1i}} & \text{if } v > v_{2i} \\ (X_{2i}/v)^{D_{2i}} & \text{if } v \leq v_{2i} \end{cases}$$

$$\leq 1.0$$

$$\geq 0.0$$
- X_{1i} , D_{1i} , v_{2i} , X_{2i} , and D_{2i} are specified for each material group i (in cells I35:I40, J35:J40, K35:K40, L35:L40, and M35:M40, respectively).

- The maximum amount of dissolved constituents for each of the material groups p which will precipitate out as free particles (rather than as cements) given large available waste porosity $(w_p/w_d)_p$ (in cells E47:E52).
- The average size distribution for free particles which precipitate out for each of the material groups p ($CCF\{v\}_p$, in terms of the CCF or percent of particles larger than a particular size). For each material group, this is expressed in terms of a piece-wise power law CCDF, where

$$\begin{aligned}
 CCF\{v\}_p &= (X_{1p}/v)^{D_{1p}} \text{ if } v > v_{2p} \\
 &= (X_{2p}/v)^{D_{2p}} \text{ if } v \leq v_{2p} \\
 &\leq 1.0 \\
 &\geq 0.0
 \end{aligned}$$

X_{1p} , D_{1p} , v_{2p} , X_{2p} , and D_{2p} are specified for each material group p (in cells I47:I52, J47:J52, K47:K52, L47:L52, and M47:M52, respectively).

The initial amounts and particle size distributions of various wastes types at a random location are actually uncertain and a function of the large scale average, the variability and critical scale of the material (cells H13:I30 for detailed materials or cells D35:E40 for material groups), the specified scale and vertical location (cells F4 and F5, respectively, referencing PAInput), although this is not currently implemented. As discussed in Section B.1.1, a set of representative mixtures of these material groups (in terms of volume percent), and the relative frequency and scale of each mixture could be specified.

2. The PA input parameters (as provided by PA codes) are specified in sheet "PAInput":
 - The characteristics of inadvertent intrusion at a random areal location, include
 - the time of interest (t , in years after closure) (cell B2);
 - the scale of interest (v , in cubic meters) (cell B3); and
 - the vertical location of interest (h , e.g., at the top of the waste room for spallings or the entire room height for cavings) (cell B4).

Although the time, scale, and vertical location of interest are specified, they are not currently used as variables in the model to predict future repository conditions, only as labels.

- The predicted repository conditions at a random areal location and at the specified time, scale, and vertical location of interest (i.e., for inadvertent intrusion), include
 - the total amount $((w/w_0)_1)$, in percent by volume of material remaining) and average depth (Δr_{1i} , in meters) of corrosion of Fe- and Al-based metals (in cells B8 and C8, respectively);
 - the total amount $((w/w_0)_4)$, in percent by volume of material remaining) and average depth (Δr_{4i} , in meters) of biodegradation of cellulose/solid organics (in cells B9 and C9, respectively);
 - the total amount $((w/w_0)_5)$, in percent by volume of material remaining) and average depth (Δr_{5i} , in meters) of biodegradation of rubber/plastics (in cells B10 and C10, respectively);
 - the total amount $((w/w_0)_6)$, in percent by volume of material remaining) and average depth (Δr_{6i} , in meters) of dissolution of MgO backfill (in cells B11 and C11, respectively);

- the waste porosity available for cementation (n_t , in percent of room volume after closure which is void space) (in cell B14);
- the amount of salt precipitated out due to brine consumption during corrosion and MgO dissolution (Δw_{3t} , in percent by weight of initial room contents) (in cell B15); and
- salt encapsulation due to continued creep (Δv_{Rt} , in percent of room volume after closure which is intruded by salt (in cell B16)).

Ideally, the above parameters should consider the coupled processes of creep, brine inflow, corrosion, dissolution, precipitation, biodegradation and gas generation which occur with time (Figure 2-1). These parameters may be: variable and uncertain for a random areal location; correlated among locations and with each other; and a function of the specified time (t), scale (v) and location in the room (h). Several of the parameters can be derived from others:

- The amount of material remaining (w_{it}) and the average depth (Δr_{it}) of the process at time t are related by:

$$(w_{i0} - w_{it})/w_{i0} = (W_{i0}/\gamma_{i0} - W_{it}/\gamma_{it}) / (W_{i0}/\gamma_{i0})$$

where for spherical volumes

$$w_{i0} \text{ (total initial volume)} = \int (\pi/6) d_{i0}^3 f\{d_{i0}\} d(d_{i0})$$

$$w_{it} \text{ (total volume at time } t) = \int (\pi/6) d_{it}^3 f\{d_{it}\} d(d_{it})$$

$$d_{it} \text{ (particle size at time } t) = d_{i0} - 2\Delta r_{it}$$

If the change in density (and associated volumetric change) is ignored and the average depth of process is independent of size, only the initial amount of material and its initial particle size distribution (or for an approximate solution, its average particle size) are needed to quantify this relationship.

$$\begin{aligned} \Delta \text{total mass} &= \Delta \text{total volume} * \text{density} \\ &= \{ \text{initial total volume} - \text{total volume at time } t \} \text{density} \\ &= X \{ \sum_v v f\{v\}_0 - \sum_{v^*} v^* f\{v^*\}_t \} \text{density} \end{aligned}$$

where

$$\begin{aligned} X &= \text{initial total volume} / \sum_v v f\{v\}_0 \\ v^* &= \pi \{ (6v/\pi)^{1/3} - 2\Delta r \}^3 / 6 \\ f\{v^*\}_t &= f\{v\}_0 \end{aligned}$$

- The amount of salt precipitated out from brine during corrosion and dissolution of MgO (Δw_{3t}) is simply 16% (i.e., the salt saturation limit of the brine) of the amount of brine consumed during those processes. It is anticipated that the inverse relationship between corrosion and MgO dissolution, where the combined amount of corrosion and of MgO dissolution are brine limited, will be defined by PA. Once the approximate ratio of MgO dissolution to corrosion has been determined, PA results, which only currently consider corrosion and ignore MgO dissolution, can be appropriately modified.

- The amount of salt encapsulation can be determined approximately as the difference in room closure between a room filled with waste (which has a finite stiffness) and an empty room. The change in mass for a material group is related to the specified Δr as follows:
3. The initial amounts of each of the detailed waste materials (W_{j0}) are normalized (to sum to 100%) and can be sampled differently from the large scale average for the specified scale and vertical location of interest (in cells C13:C30), although this is not currently done. The amounts of each of the detailed materials for the large scale average and for the specified scale and vertical location of interest are then combined, based on their group number, to determine the relative amount of each material group (in cells B35:B40 for large scale average and in cells C35:C40 for the specified scale and vertical location of interest). Again, however, these weight percentages are not subsequently used to develop particle size distributions.
 4. The piece-wise power law presented in step 1 is used to determine the CCF for specific particle sizes (each order of magnitude) for each material group (in cells O35:AL40), assuming an absolute minimum size of $1E-19 \text{ m}^3$ (CCF=1.0) and an absolute maximum size of $1E+4 \text{ m}^3$ (CCF=0.0).
 5. The CCFs for each particle size for each material group are combined for all material groups to determine the CCF for specific particle sizes for the composite material (in cells O41:AL41), based on:

$$CCF\{v\}_0 = \sum_i w_{i0} CCF\{v\}_{i0}$$

where

$CCF\{v\}_0$ is the initial CCF for particle size v for the composite material
 w_{i0} is the initial percent of the composite material comprised by material i
 $CCF\{v\}_{i0}$ is the initial CCF for particle size v for material i

The set of CCFs for various possible values of v is termed the CCF distribution (CCDF). The CCDF from this step is the "initial" result (copied to cells B64:Y64). The "initial" CDF is derived by subtracting each CCF from 1.0 (in cells B71:Y71) and is plotted in "Results". This represents the particle size distribution prior to any reduction, cementation or encapsulation processes.

6. The CCDF for each material group is binned in terms of order of magnitude, with each bin represented by its logarithmic mid-point (in cells BL34:CH34)

$$v^* = 10^{\{(\log v_L + \log v_U)/2\}}$$

The relative frequency of each bin is then determined for each material group as the difference in the CCFs at the end points of each bin for that group (in cells BL35:CH40)

$$f\{v^*\}_{i0} = CCF\{v_L\}_{i0} - CCF\{v_U\}_{i0}$$

The average or mean particle size for each material group is determined (in cells CI35:CI40)

$$m\{v\}_{i0} = \sum_{v^*} v^* f\{v^*\}_{i0}$$

7. Each of the particle sizes is reduced for each group (in cells P47:AK52), based on the specified change (if any) in the radius of equivalent spherical particles for that group (due to the specific reduction process involved and the time of interest), as follows:

$$v_{it} = \pi (d_{i0} - 2\Delta r_{it})^3 / 6$$

$$\geq 0.0$$

where

v_{it} is the reduced particle size (volume)

d_{i0} is the initial particle diameter = $(6 v_{i0} / \pi)^{1/3}$

v_{i0} is the initial particle size (volume) (in cells P46:AK46)

Δr_{it} is the change in particle radius (in cells D47:D52, copied from PAInput)

8. The CCF of the specific particle sizes (i.e., each order of magnitude) considering the effects of reduction processes (corrosion, biodegradation and dissolution) is determined as follows:

- It is recognized that the cumulative frequency of the reduced particle size is the same as that of its initial particle size (i.e., there are the same number of particles in each bin, but the characteristic size for each bin has been reduced). The reduced sizes for each material group (cells P47:AK52) and their associated CCFs (cells P35:AK40) are copied to a separate spread sheet (cells B3:Y3 and B4:Y4, respectively, in "Group1", "Group2", "Group3", "Group4", "Group5", and "Group6", as appropriate).
- The largest reduced size (v_L) less than each specific particle size (i.e., each order of magnitude, cells B6:Y6 in each "Groupi") is identified for each material group (in cells B7:Y7 in each "Groupi"). The smallest reduced size (v_U) greater than the specific particle size is by definition the next one larger than v_L .
- The CCF for each specific particle size (cells B6:Y6 in each "Groupi") is then interpolated between the known particle size and CCF pairs (in cells B3:Y4 in each "Groupi"), using a logarithmic linear algorithm (in cells B9:Y9 in each "Groupi", which is then copied back to cells AN47:BI52 in "WP_size"):

$$CCF\{v^*\} = 10^{\{\log CCF\{v_L\} - [\log CCF\{v_L\} - \log CCF\{v_U\}] \cdot [\log v^* - \log v_L] / [\log v_U - \log v_L]\}}$$

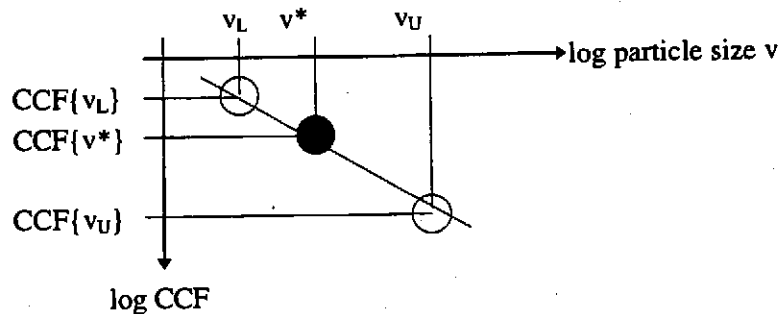

9. Similar to step 6, the CCDF for reduced particle sizes ($CCF\{v\}_{in}$, cells AM47:BJ52) is binned in terms of order of magnitude; the logarithmic average value is determined for each bin (in cells BL46:CH46); the relative frequency of each bin ($f\{v\}_{in}$) is determined by the difference in CCFs at the end points of each bin (in cells BL47:CH52); and the average particle size ($m\{v\}_{in}$) is determined for each material group (in cells CI46:CI52).
10. The total amounts (w_{it} and w_{pdt} , in terms of percent of original volume) of each group that is remaining (i.e., not corroded, dissolved or biodegraded) and that is dissolved, respectively, is determined (in cells F47:F52 and AH59:AH6I, respectively) from the original volume

amounts (w_{i0} , cells C35:C40) and the predicted remaining amounts ($(w_r/w_0)_i$, cells C47:C52) for each group

$$w_{it} = w_{i0} (w_r/w_0)_i$$

$$w_{pdt} = w_{i0} [1 - (w_r/w_0)_i] \text{ only for material groups 1 and 6}$$

The amount of salt that is dissolved (Δw_{3t} , in brine that will be consumed during various processes) is in addition to, and specified (in cell B60, copied from "PAInput") independently from, the original amount of salt fragments.

11. The amount (if any) (in terms of percent of original volume) of each group that goes into cement (w_{pct}) is determined (in cells A159:AJ61, copied to cells G47:G52) as the sum of the specified percent for large available porosity for each group, plus the increment for each group that is proportional to the ratio of the total minimum amount of cement (from all groups) to the specified total available porosity

$$w_{pct} = w_{pdt} [1 - (w_p/w_d)_p] + \left\{ \sum_p w_{pdt} [1 - (w_p/w_d)_p] \right\} w_{pdt} (w_p/w_d)_p / n_i$$

$$\leq w_{pdt}$$

$$\geq 0$$

where

$(w_p/w_d)_p$ is the maximum amount of dissolved material for group p which will precipitate out as free particles if there is large available waste porosity (cells E47:E52)

n_i is waste porosity (cell B59, copied from "PAInput")

12. The amount (if any) (w_{pt} , in terms of percent of original volume) of each group which precipitates out as free particles is determined as the difference between the total amount dissolved (w_{pdt}) and the amount that goes into cement (w_{pct}) (in cells AK59:AK61, which are copied to cells H47:H52)

$$w_{pt} = w_{pdt} - w_{pct}$$

13. Similar to step 4, the CCF of specific particle sizes (i.e., each order of magnitude, cells AM58:BJ58) ($CCF\{v\}_{pt}$) is determined (in cells AM59:BJ61) for free particles which precipitate out for each material group that has dissolved constituents (Fe- and Al-based metals, brine and MgO), based on their specified piece-wise power law (cells I47:M52).

14. The percentage of the total amounts of particles related to the remaining material (w_{it^*}) and to the precipitated free particles of each group (w_{pt^*}) is determined (in cells BK47:BK52 and BK59:BK61, respectively)

$$w_{it^*} = w_{it} / \{ \sum_i w_{it} + \sum_p w_{pt} \}$$

$$w_{pt^*} = w_{pt} / \{ \sum_i w_{it} + \sum_p w_{pt} \}$$

15. The CCF of specific particle sizes (i.e., each order of magnitude, cells AM58:BJ58) is determined for the combination of all remaining materials and precipitated free particles (in cells AM63:BJ63), based on:

$$CCF\{v\}_{rpt} = \sum_i w_{it^*} CCF\{v\}_{it} + \sum_p w_{pt^*} CCF\{v\}_{pt}$$

where

$CCF\{v\}_{rpt}$ is the CCF for particle size v for the composite material, after reduction and precipitation of free particles

w_{it^*} is the percent of the composite material comprised by remaining material i

$CCF\{v\}_{it}$ is the CCF for particle size v for remaining material i

w_{pt} is the percent of the composite material comprised by precipitated free particles of material p

$CCF\{v\}_{pt}$ is the CCF for particle size v for precipitated free particles of material p

This CCDF is the "reduction" result (copied to cells B65:Y65). The "reduction" CDF is derived by subtracting each CCF from 1.0 (in cells B72:Y72), and is plotted in "Results." This represents the particle size distribution considering reduction processes, but not considering any cementation or encapsulation processes.

16. Similar to step 6, the CCDF for reduced particle (and precipitated free particle) sizes of the composite material ($CCF\{v\}_{rpt}$, cells AM63:BJ63) is binned in terms of order of magnitude; the logarithmic average value is determined for each bin (in cells BL46:CH46); the relative frequency ($f\{v\}_{rpt}$) of each bin is determined by the difference in CCFs at the end points of each bin (in cells BL63:CH63); and the average particle size ($m\{v\}_{rpt}$) is determined (in cell CI63).

17. The un-normalized relative frequency for aggregated particles (due to cementation) is determined (in cells BL64:CH64) by multiplying the relative frequency of each bin by that bin's average value, i.e., the likelihood of each particle remaining uncemented is inversely proportional to its size (e.g., a particle 10 times smaller than another is 10 times more likely to be aggregated with other particles and not remain as a separate particle). The relative frequency for aggregated particles is then normalized to sum to 1.0 (in cells BL65:CH65)

$$f\{v\}_{ct} = v f\{v\}_{rpt} / \sum_v v f\{v\}_{rpt}$$

The average aggregated particle size ($m\{v\}_{ct}$) is determined (in cell CI65) in the same way as in step 6.

18. The CCF of specific sizes (i.e., each order of magnitude) for aggregated particles is determined by summing the normalized relative frequencies for all larger particles (from cells BL65:CH65 in cells B66:Y66)

$$CCF\{v\}_{ct} = \sum_{\text{for all } v^* > v} f\{v^*\}_{ct}$$

This CCDF is the "reduction+cementation" result. The "reduction + cementation" CDF is derived by subtracting each CCF from 1.0 (in cells B73:Y73), and is plotted in "Results." This represents the particle size distribution considering reduction and cementation processes, but not considering encapsulation processes.

19. The relative frequencies for specific sizes for aggregated particles (considering reduction and cementation) are uniformly reduced by the specified amount of salt encapsulation (from cell B61, copied from "PAInput," in cells BL66:CH66), with the amount of salt encapsulation added to a specified large size bin (e.g., 10 to 100 m³) (in cells BL67:CH67)

$$f\{v\}_t = \Delta v_{Rt} [f\{v\}_{ct} + g\{v\}]$$

where

$$g\{v\} = \begin{cases} = 0 & \text{for all } v \text{ except for the specified large size bin} \\ = 1 & \text{for } v \text{ equal to the specified large size bin} \end{cases}$$

The average particle size ($m\{v\}_t$) is determined (in cell CI67) in the same way as in step 6.

20. Similar to step 18, the CCF of specific particle sizes (i.e., each order of magnitude, cells B67:Y67), considering encapsulation as well as reduction and cementation ($CCF\{v\}_t$), is determined (in cells B67:Y67) by summing the relative frequencies ($f\{v\}_t$) for all larger particles (from cells BL67:CH67). This CCDF is the "reduction+cementation+encapsulation" result. The "reduction + cementation +

encapsulation" CDF is derived by subtracting each CCF from 1.0 (in cells B74:Y74), and is plotted in "Results". This represents the particle size distribution considering reduction, cementation and encapsulation processes.

B.2.2 List of Parameters

- v - particle size (volumetric in m^3)
- d - diameter (in m) of sphere of equivalent volume v
- r - radius (in m) of sphere of equivalent volume v
- W - amount (in % weight) of a material
- w - amount (in volume) of a material
- $CCF\{x\}$ - complementary cumulative frequency (i.e., % exceeding) of value of x
- $f\{x\}$ - relative frequency (in %) of value of x
- $m\{x\}$ - average value of x
- W_{j0} - initial amount (% by weight of room contents) comprised of detailed material type j
- w_{i0} - initial amount (% by volume of room contents) comprised of material group type i
- ilj - material group i within which detailed material type j belongs (due to similar effects of processes)
- X_{1ib} D_{1ib} V_{2ib} X_{2ib} and D_{2i} - parameters for piece-wise power law CCDF describing $CCF\{v\}_{i0}$
- X_{1ip} D_{1ip} V_{2ip} X_{2ip} and D_{2p} - parameters for piece-wise power law CCDF describing $CCF\{v\}_p$
- $(w_p/w_d)_p$ - percent of dissolved material group p which will precipitate out as free particles given large available porosity
- $(w/w_0)_i$ - percent of material group i remaining after reduction process at time t
- Δr_{it} - average depth (= change in radius of spherical particle, in m) of reduction process at time t
- n_t - waste porosity at time t
- Δw_{3t} - amount (% by volume of original room contents) of salt precipitated out due to brine consumption
- Δv_{Rt} - amount (% by volume of room contents after closure) of waste which is encapsulated by intruding salt
- d_{i0} - an initial equivalent particle diameter size for material group i
- v_{i0} - an initial particle size for material group i
- v_{it} - a particle size for material group i at time t
- w_{it} - amount (% by volume of original room contents) comprised of material group type i remaining at time t
- w_{pt} - amount (% by volume of original room contents) comprised of material group type p precipitated out as free particles at time t
- w_{it}^* - amount (% by volume of non-cemented particles) comprised of remaining material group type i at time t
- w_{pt}^* - amount (% by volume of non-cemented particles) comprised of precipitated free particles of material group type p at time t
- w_{pdt} - amount (% by volume of original room contents) comprised of material group type p which is dissolved at time t
- w_{pct} - amount (% by volume of original room contents) comprised of material group type p which is precipitated out as cement at time t
- $CCF\{v\}_{i0}$ - initial particle size distribution (frequency of exceedance) for material group i
- $CCF\{v\}_p$ - particle size distribution (frequency of exceedance) for free particles which precipitate out for material group p
- $CCF\{v\}_0$ - initial particle size distribution (frequency of exceedance) for composite material
- $f\{v\}_{i0}$ - the initial relative frequency of v for material group i
- $m\{v\}_{i0}$ - the initial average value of v for material group i

- $CCF(v)_{in}$ - particle size distribution (frequency of exceedance) for material group i at time t considering reduction processes only
- $f(v)_{in}$ - the relative frequency of v for material group i at time t considering reduction processes only
- $m(v)_{in}$ - the average value of v for material group i at time t considering reduction processes only
- $CCF(v)_{pt}$ - particle size distribution (frequency of exceedance) for material group p at time t considering precipitation of free particles only
- $CCF(v)_{rpt}$ - particle size distribution (frequency of exceedance) for composite material at time t considering reduction processes and precipitation of free particles only
- $f(v)_{rpt}$ - the relative frequency of v for composite material at time t considering reduction processes and precipitation of free particles only
- $m(v)_{rpt}$ - the average value of v for composite material at time t considering reduction processes and precipitation of free particles only
- $CCF(v)_{ca}$ - particle size distribution (frequency of exceedance) for composite material at time t considering reduction processes, precipitation of free particles, and cementation only
- $f(v)_{ca}$ - the relative frequency of v for composite material at time t considering reduction processes, precipitation of free particles, and cementation only
- $m(v)_{ca}$ - the average value of v for composite material at time t considering reduction processes, precipitation of free particles, and cementation only
- $CCF(v)_i$ - particle size distribution (frequency of exceedance) for composite material at time t considering reduction processes, precipitation of free particles, cementation, and encapsulation
- $f(v)_i$ - the relative frequency of v for composite material at time t considering reduction processes, precipitation of free particles, cementation, and encapsulation
- $m(v)_i$ - the average value of v for composite material at time t considering reduction processes, precipitation of free particles, cementation, and encapsulation

B.3 Results

B.3.1 Format

The results of the decomposition model include the CCF and the cumulative frequency for various particles sizes (expressed volumetrically in cubic meters), for the following cases:

- initial conditions (considering crushing due to room closure but not other reduction, cementation, or encapsulation processes),
- considering reduction but not cementation, or encapsulation,
- considering reduction and cementation but not encapsulation, and
- considering reduction, cementation, and encapsulation.

These results are tabulated as well as graphed.

If the PA inputs are expressed probabilistically (e.g., either as correlated pdfs or as a set of equally likely combinations of conditions), the results can be developed and expressed probabilistically. For example, a set of realizations of population distributions can be generated, or the uncertainty in specific characteristics (e.g., average or ten percentile values) of the population distributions can be determined.

B.3.2 Discussion

At the time of an intrusion (e.g., cavings or spillings), there will be a true population distribution of particle sizes in the repository (i.e., a specific percentage of the particles will exceed a particular size). As discussed in Section 4 of the report, the results of the decomposition model

express the expected population of particle sizes within the repository at the specified time of inadvertent intrusion, based on the predicted repository conditions (from PA). Although there is uncertainty in what this population will be for a particular set of repository conditions (e.g., due to uncertainties in the initial waste characteristics and in the effects of repository conditions), this uncertainty is considered to be relatively insignificant compared to the uncertainty in the predicted future repository conditions. Hence, the uncertainty in the population of particle sizes can be determined by Monte Carlo simulation, in which the set of repository conditions is sampled and used to develop numerous realizations of the population distribution of particle sizes.

It should be emphasized that the population distribution represents the inherent variability in particle sizes. For example, in evaluating inadvertent intrusion scenarios, it would be inappropriate to sample a single particle size from the population distribution, as if the entire population was uniformly that size. Instead, the entire population (or critical characteristic such as the mean or 10 percentile) should be sampled and used in evaluating the scenario. This could produce very different results, depending on whether natural variability (i.e., the degree of uniformity) in particle size or uncertainty in predictions of repository performance dominate.

It should also be noted that the population distributions at a particular time will vary among locations, depending on the scale involved. As the scale increases, each location becomes a representative sample of the repository, with a similar population distribution. However, at small scale, there may be significant differences in population distributions. For example, at the scale of individual waste containers (which might be appropriate for intrusion scenarios), the particle size populations might be very different from location to location, reflecting primarily differences in the original contents of the waste containers and to a lesser extent differences in repository conditions at that scale. Ideally, this variability in populations (at the appropriate time and scale of intrusion) would be considered when sampling for a random location of intrusion. Although recognized and discussed qualitatively, this effect of scale on the variability of particle size populations has not yet been incorporated in the decomposition model. Instead, the average or large scale particle size population distribution is developed. The population distribution at small scale will have smaller variability, and the average values for different locations will vary over a wide range, reflecting different and more uniformly graded materials at different locations at that scale, which become mixed at larger scale. The additional effect of scale on the uncertainty in particle size distribution could be incorporated relatively easily, considering the small scale variability in both the initial waste mixtures and in the future repository conditions. In order to do this, the decomposition model presented here would not need to change, except that the mixture of material groups, as well as the future repository conditions would be sampled considering their small scale variability (as well as the uncertainty in future repository conditions), if quantified. However, the need for considering small scale variability and the implementation of the decomposition model in PA is outside the scope of this elicitation.

	A	B	C	D	E	F	G	H	I	J	
1	WASTE PARTICLE SIZE DECOMPOSITION MODEL										
2	for DOE-CRO-CAO/CTAC/MPP										
3	WJR-Golder, 944-2001-97.8111, file: WP_DIA4.xls					Inputs for random intrusion					
4	30-May-97					Time of Interest (years)		2000			
5	NOTE: Input cells in blue.					Scale of Interest (m ³)		10			
6						Vertical Location ("top" or "room")		top			
7	Initial Wt% at random location is actually uncertain and function of large scale average, variability and critical scale of material (cells B12:D29 or B34:E34), specified scale (cell F4) and location (cell F5),										
8	although this is not currently implemented.										
9											
10	MATERIAL PROPERTIES (Initial)			At random location			Initial Particle Size				
11	Initial Wt %		Initial Wt %	Density	Composite	v (m ³)	Critical	Variability/			
12	Materials		Large Scale	Spec Scale	(gm/cc)	Material Type	Minimum	Maximum	Scale (m ³)	Uncertainty	
13	iron-base metal/alloys			11.4%							
14	aluminum-base metal/alloys			1.2%							
15	other metal/alloys			5.1%							
16	other inorganic materials			2.2%							
17	vitrified			3.6%							
18	cellulosics			3.6%							
19	rubber			0.6%							
20	plastics			2.3%							
21	solidified inorganic materials			3.6%							
22	solidified organic material			0.4%							
23	cement (solidified)			3.4%							
24	soils			2.9%							
25	steel packaging			10.4%							
26	plastics packaging			1.7%							
27	lead packaging			1.3%							
28	steel plug packaging			5.9%							
29	MgO backfill			31.3%							
30	salt			9.1%							
31	total		110.1%	100.0%							
32											
33	Initial Wt %		critical	variability/	Initial Particle Size		Initial VoF%	Power Law Distribution			
34	material groups		average	location	scale (m ³)	uncertainty	Minimum	Maximum	location	X1	ID1
35	1. Fe&Al-base metals		28.9%	28.9%	0.00	0	1.00E-09	1.00E-09	1.00E-10	1.00E-08	0.88
36	2. non-iron metals/inorg/vitrif		22.1%	22.1%	0.00	0	1.00E-10	1.00E-10	1.00E-10	1.00E-10	0.88
37	3. salt		9.1%	9.1%	0.00	0	1.00E-09	1.00E-09	1.00E-10	1.00E-10	1.00
38	4. cellulosics/solid organics		4.0%	4.0%	0.00	0	1.00E-09	1.00E-09	1.00E-10	1.00E-10	0.05
39	5. rubber/plastics		4.6%	4.6%	0.00	0	1.00E-09	1.00E-09	1.00E-10	1.00E-10	1.15
40	6. MgO backfill		31.3%	31.3%	0.00	0	1.00E-10	1.00E-10	25.5%	10.00E+00	1.00
41	total		100.0%	100.0%							100.0%
42											
43	EFFECT OF MATERIAL SPECIFIC PROCESSES										
44											
45				max% degrad	% total orig wt	% total orig wt	% total orig wt	Power Law Distribution			
46	Material groups			Process	% remain	radius (m)	free particulate	remaining	precipitated	precipitated	(X1/v)*D1 for v>v2, =X
47	1. Fe&Al-base metals			corrosion	50%	1.00E-05	26%	7%	7%	0%	
48	2. non-iron metals/inorg/vitrif			inert	100%	0	0	24%	0%	0%	
49	3. salt			inert	100%	0	0	12%	10%	0%	
50	4. cellulosics/solid organics			biodegrad	50%	1.00E-05	0	7%	0%	0%	
51	5. rubber/plastics			biodegrad	50%	1.00E-05	0	6%	0%	0%	
52	6. MgO backfill			dissolution	50%	1.00E-05	26%	13%	13%	0%	
53											
54	NOTE: % remain, radius, waste porosity, salt precipitation and salt encapsulation are related and are specified by PA as a function of time (cell F3),										
55	considering coupled processes of brine inflow, corrosion, dissolution, biodegradation and gas generation.										
56	It is assumed that degradation products in addition to porosity will precipitate out as free particles, although they are cemented together anyway.										
57	Also, parameters may be variable and uncertain for random location, correlated, and function of specified scale and room location (cells F4 and F5).										
58											
59	Waste porosity ¹			20%							
60	Salt precipitation ²			10%							
61	Salt encapsulation ²			10%							
62	RESULTS - CCDF										
63	Condition		1.00E-19	1.00E-18	1.00E-17	1.00E-16	1.00E-15	1.00E-14	1.00E-13	1.00E-12	1.00E-11
64	initial		1.00E+00	1.00E+00	8.92E-01	8.81E-01	6.76E-01	6.49E-01	6.46E-01	6.45E-01	6.45E-01
65	reduced		1.00E+00	1.00E+00	8.41E-01	8.25E-01	5.22E-01	4.82E-01	4.77E-01	4.76E-01	4.56E-01
66	reduced+cemented		1.00E+00	1.00E+00	1.00E+00	1.00E+00	1.00E+00	1.00E+00	1.00E+00	1.00E+00	1.00E+00
67	reduced+cemented+encapsul		1.00E+00	1.00E+00	1.00E+00	1.00E+00	1.00E+00	1.00E+00	1.00E+00	1.00E+00	1.00E+00
68											
69	RESULTS - CDF										
70	Condition		1.00E-19	1.00E-18	1.00E-17	1.00E-16	1.00E-15	1.00E-14	1.00E-13	1.00E-12	1.00E-11
71	initial		0.00E+00	0.00E+00	1.08E-01	1.19E-01	3.24E-01	3.51E-01	3.54E-01	3.55E-01	3.55E-01
72	reduced		1.11E-16	1.11E-16	1.59E-01	1.75E-01	4.78E-01	5.18E-01	5.23E-01	5.24E-01	5.44E-01
73	reduced+cemented		0.00E+00	0.00E+00	8.44E-15	1.69E-14	1.63E-12	3.75E-12	6.55E-12	1.02E-11	1.09E-09
74	reduced+cemented+encapsul		0.00E+00	0.00E+00	7.68E-15	1.53E-14	1.47E-12	3.38E-12	5.89E-12	9.21E-12	9.81E-10



	K	L	M	N	O	P	Q	R	S	T	U	V	W	X	Y		
1																	
2																	
3																	
4																	
5																	
6																	
7																	
8																	
9																	
10	Minimum Diameter for each Material Type												Maximum Diameter for each Material Type				
11							1	2	3	4	5	6	1	2	3		
12							0	NA	NA	NA	NA	NA		0	NA	NA	
13							0	NA	NA	NA	NA	NA		0	NA	NA	
14													NA		0	NA	
15							NA		0	NA	NA	NA	NA		0	NA	
16							NA		0	NA	NA	NA	NA		0	NA	
17							NA	NA		NA		0	NA	NA	NA	NA	
18							NA	NA	NA		NA		0	NA	NA	NA	
19							NA	NA	NA	NA		0	NA	NA	NA	NA	
20							NA	NA	NA	NA		0	NA	NA	NA	NA	
21							NA	NA	NA	NA		0	NA	NA	NA	NA	
22							NA	NA	NA	NA		0	NA	NA	NA	NA	
23							NA	NA	NA	NA		0	NA	NA	NA	NA	
24							NA	NA	NA	NA		0	NA	NA	NA	NA	
25							NA	NA	NA	NA		0	NA	NA	NA	NA	
26							NA	NA	NA	NA		0	NA	NA	NA	NA	
27							NA	NA	NA	NA		0	NA	NA	NA	NA	
28							NA	NA	NA	NA		0	NA	NA	NA	NA	
29							NA	NA	NA	NA		0	NA	NA	NA	NA	
30							NA	NA	NA	NA		0	NA	NA	NA	NA	
31							0	0	0	0	0	0	0	0	0	0	
32	1-F(v(m3))						complementary cumulat										
33	2(v)^D2 for v<v2						low bound										
34	v2	X2	D2				1.00E-19	1.00E-18	1.00E-17	1.00E-16	1.00E-15	1.00E-14	1.00E-13	1.00E-12	1.00E-11	1.00E-10	1.00E-09
35	1.00E-06	1.00E-06	0.0043				1.00E+00	1.00E+00	1.00E+00	1.00E+00	1.00E+00	1.00E+00	1.00E+00	1.00E+00	1.00E+00	1.00E+00	1.00E+00
36	1.00E-06	1.00E-06	0.0043				1.00E+00	1.00E+00	1.00E+00	1.00E+00	1.00E+00	1.00E+00	1.00E+00	1.00E+00	1.00E+00	1.00E+00	1.00E+00
37	1.00E-06	1.00E-06	0.0043				1.00E+00	1.00E+00	1.00E+00	1.00E+00	1.00E+00	1.00E+00	1.00E+00	1.00E+00	1.00E+00	1.00E+00	1.00E+00
38	1.00E-06	1.00E-06	0.0043				1.00E+00	1.00E+00	1.00E+00	1.00E+00	1.00E+00	1.00E+00	1.00E+00	1.00E+00	1.00E+00	1.00E+00	1.00E+00
39	1.00E-06	1.00E-06	0.0043				1.00E+00	1.00E+00	1.00E+00	1.00E+00	1.00E+00	1.00E+00	1.00E+00	1.00E+00	1.00E+00	1.00E+00	1.00E+00
40	1.00E-06	1.00E-06	0.0043				1.00E+00	1.00E+00	1.00E+00	1.00E+00	1.00E+00	1.00E+00	1.00E+00	1.00E+00	1.00E+00	1.00E+00	1.00E+00
41					composite		1.00E+00	1.00E+00	8.92E-01	8.81E-01	6.76E-01	6.48E-01	6.46E-01	6.45E-01	6.45E-01	5.25E-01	5.14E-01
42																	
43	test																
44	1-F(v(m3))						reduced particle size (v in m3), relative to original size, due										
45	2(v)^D2 for v<v2						low bound										
46	v2	X2	D2				1.00E-19	1.00E-18	1.00E-17	1.00E-16	1.00E-15	1.00E-14	1.00E-13	1.00E-12	1.00E-11	1.00E-10	1.00E-09
47	1.00E-17						0.00E+00	0.00E+00	0.00E+00	0.00E+00	0.00E+00	1.60E-16	2.78E-14	5.90E-13	7.92E-12	8.99E-11	9.52E-10
48	1.00E-17						1.00E-18	1.00E-17	1.00E-16	1.00E-15	1.00E-14	1.00E-13	1.00E-12	1.00E-11	1.00E-10	1.00E-09	1.00E-09
49	1.00E-17						1.00E-18	1.00E-17	1.00E-16	1.00E-15	1.00E-14	1.00E-13	1.00E-12	1.00E-11	1.00E-10	1.00E-09	1.00E-09
50	1.00E-17						0.00E+00	0.00E+00	0.00E+00	0.00E+00	0.00E+00	1.60E-16	2.78E-14	5.90E-13	7.92E-12	8.99E-11	9.52E-10
51	1.00E-17						0.00E+00	0.00E+00	0.00E+00	0.00E+00	0.00E+00	1.60E-16	2.78E-14	5.90E-13	7.92E-12	8.99E-11	9.52E-10
52	1.00E-17						0.00E+00	0.00E+00	0.00E+00	0.00E+00	0.00E+00	1.60E-16	2.78E-14	5.90E-13	7.92E-12	8.99E-11	9.52E-10
53																	
54																	
55																	
56																	
57																	
58																	
59																	
60																	
61																	
62	size (v in m3), average in repository																
63	1.00E-10	1.00E-09	1.00E-08	1.00E-07	1.00E-06	1.00E-05	1.00E-04	1.00E-03	1.00E-02	1.00E-01	1.00E+00	1.00E+01	1.00E+02	1.00E+03	1.00E+04		
64	5.25E-01	5.14E-01	2.57E-01	2.55E-01	2.54E-01	1.05E-01	6.75E-02	4.85E-03	3.63E-04	2.84E-05	2.36E-06	2.13E-07	2.11E-08	2.29E-09	0.00E+00		
65	3.86E-01	1.93E-01	1.89E-01	1.88E-01	1.87E-01	7.77E-02	4.97E-02	3.58E-03	2.88E-04	2.09E-05	1.74E-06	1.57E-07	1.56E-08	1.69E-09	0.00E+00		
66	1.00E+00	1.00E+00	1.00E+00	1.00E+00	1.00E+00	9.94E-01	9.79E-01	7.34E-01	5.57E-01	4.26E-01	3.23E-01	2.39E-01	1.64E-01	8.99E-02	1.53E-16		
67	1.00E+00	1.00E+00	1.00E+00	1.00E+00	1.00E+00	9.95E-01	9.81E-01	7.60E-01	6.02E-01	4.83E-01	3.91E-01	3.15E-01	1.47E-01	8.09E-02	-2.91E-16		
68																	
69	size (v in m3), average in repository																
70	1.00E-10	1.00E-09	1.00E-08	1.00E-07	1.00E-06	1.00E-05	1.00E-04	1.00E-03	1.00E-02	1.00E-01	1.00E+00	1.00E+01	1.00E+02	1.00E+03	1.00E+04		
71	4.75E-01	4.86E-01	7.43E-01	7.45E-01	7.46E-01	8.95E-01	9.33E-01	9.95E-01	1.00E+00	1.00E+00	1.00E+00	1.00E+00	1.00E+00	1.00E+00	1.00E+00	1.00E+00	1.00E+00
72	6.14E-01	8.07E-01	8.11E-01	8.12E-01	8.13E-01	8.22E-01	9.50E-01	9.96E-01	1.00E+00	1.00E+00	1.00E+00	1.00E+00	1.00E+00	1.00E+00	1.00E+00	1.00E+00	1.00E+00
73	3.81E-08	1.07E-06	1.24E-06	1.82E-06	9.81E-08	5.82E-03	2.07E-02	2.66E-01	4.43E-01	5.74E-01	6.77E-01	7.61E-01	8.36E-01	8.10E-01	1.00E+00		
74	3.43E-08	9.63E-07	1.12E-06	1.64E-06	8.83E-06	5.24E-03	1.86E-02	2.40E-01	3.98E-01	5.17E-01	6.09E-01	6.85E-01	8.53E-01	9.19E-01	1.00E+00		

Information Only

	Z	AA	AB	AC	AD	AE	AF	AG	AH	AI	AJ	AK	AL	AM	AN		
1																	
2																	
3																	
4																	
5																	
6																	
7																	
8																	
9																	
10																	
11	Critical Scale for Each Material Type									Variability for Each Material							
12	1	2	3	4	5	6	7	8	9	10	11	12	13	14	15		
13	NA	NA	NA		0/NA	NA	NA	NA	NA	NA		0/NA	NA	NA	NA		
14	NA	NA	NA		0/NA	NA	NA	NA	NA	NA		0/NA	NA	NA	NA		
15	NA	NA	NA	NA		0/NA	NA	NA	NA	NA		NA	NA	0/NA	NA		
16	NA	NA	NA	NA	NA		0/NA	NA	NA	NA		NA	NA	0/NA	NA		
17	NA	NA	NA	NA	NA	NA		0/NA	NA	NA		NA	NA	0/NA	NA		
18	NA	0/NA	NA	NA	NA	NA	NA		0/NA	NA		NA	NA	0/NA	NA		
19	NA	0/NA	0/NA	NA	NA	NA	NA	NA		0/NA		NA	NA	0/NA	NA		
20	NA	0/NA	0/NA	NA	NA	NA	NA	NA	NA			NA	NA	0/NA	NA		
21	NA	NA	NA	NA	NA		0/NA	NA	NA	NA		NA	NA	NA	0		
22	NA	0/NA	NA	NA	NA	NA		0/NA	NA	NA		NA	NA	0/NA	NA		
23	NA	NA	NA	NA	NA		0/NA	NA	NA	NA		NA	NA	0/NA	NA		
24	NA	NA	NA	NA	NA		0/NA	NA	NA	NA		NA	NA	0/NA	NA		
25	NA	NA	NA	NA	NA	0/NA	NA	NA	NA	NA		NA	NA	0/NA	NA		
26	NA	0/NA	NA	NA	NA	NA	NA		0/NA	NA		NA	NA	0/NA	NA		
27	NA	NA	NA	NA	NA	NA	NA	NA		0/NA		NA	NA	0/NA	NA		
28	NA	NA	NA	NA	NA	0/NA	NA	NA	NA	NA		NA	NA	0/NA	NA		
29	NA	NA	NA	0	NA	NA	NA	NA	NA	NA	0	NA	NA	0/NA	NA		
30	NA	NA	NA	NA	NA	NA	0/NA	NA	NA	NA		NA	NA	0/NA	0		
31	0	0	0	0	0	0	0	0	0	0	0	0	0	0	0		
32																	
33	ive frequency of initial particle size (v in m ³)													hi bound			
34	1.00E-08	1.00E-07	1.00E-06	1.00E-05	1.00E-04	1.00E-03	1.00E-02	1.00E-01	1.00E+00	1.00E+01	1.00E+02	1.00E+03	1.00E+04		0		
35	9.90E-01	8.80E-01	9.71E-01	1.32E-01	1.74E-02	2.29E-03	3.02E-04	3.98E-05	5.25E-06	6.92E-07	9.12E-08	1.20E-08			0		
36	9.12E-08	1.20E-08	1.58E-09	2.09E-10	2.75E-11	3.63E-12	4.79E-13	6.31E-14	8.33E-15	1.11E-15	1.46E-16	2.00E+00			0		
37	1.00E-10	1.00E-11	1.00E-12	1.00E-13	9.99E-15	9.99E-16	1.11E-16	0.00E+00	0.00E+00	0.00E+00	0.00E+00	0.00E+00	0.00E+00		0		
38	7.08E-04	6.31E-05	5.62E-06	5.01E-07	4.47E-08	3.98E-09	3.55E-10	3.16E-11	2.82E-12	2.51E-13	2.24E-14	2.00E-15			0		
39	1.00E+00	1.00E+00	1.00E+00	7.52E-01	5.65E-01	3.93E-02	2.79E-03	1.97E-04	1.40E-05	9.88E-07	7.00E-08	4.95E-09			0		
40	0.00E+00	0.00E+00	0.00E+00	0.00E+00	0.00E+00	0.00E+00	0.00E+00	0.00E+00	0.00E+00	0.00E+00	0.00E+00	0.00E+00			0		
41	2.57E-01	2.55E-01	2.54E-01	1.05E-01	6.75E-02	4.85E-03	3.63E-04	2.84E-05	2.36E-06	2.13E-07	2.11E-08	2.29E-09					
42																	
43																	
44																	
45	to material specific processes effect on radius													hi bound		low bound	
46	1.00E-08	1.00E-07	1.00E-06	1.00E-05	1.00E-04	1.00E-03	1.00E-02	1.00E-01	1.00E+00	1.00E+01	1.00E+02	1.00E+03	1.00E+04	1.00E-19	1.00E-18		
47	9.78E-08	8.90E-08	9.95E-07	9.98E-06	9.99E-05	1.00E-03	1.00E-02	1.00E-01	1.00E+00	1.00E+01	1.00E+02	1.00E+03		1.00E+00	1.00E+00		
48	1.00E-08	1.00E-07	1.00E-06	1.00E-05	1.00E-04	1.00E-03	1.00E-02	1.00E-01	1.00E+00	1.00E+01	1.00E+02	1.00E+03		1.00E+00	1.00E+00		
49	1.00E-08	1.00E-07	1.00E-06	1.00E-05	1.00E-04	1.00E-03	1.00E-02	1.00E-01	1.00E+00	1.00E+01	1.00E+02	1.00E+03		1.00E+00	1.00E+00		
50	9.78E-09	9.90E-08	9.95E-07	9.98E-06	9.99E-05	1.00E-03	1.00E-02	1.00E-01	1.00E+00	1.00E+01	1.00E+02	1.00E+03		1.00E+00	1.00E+00		
51	9.78E-09	9.90E-08	9.95E-07	9.98E-06	9.99E-05	1.00E-03	1.00E-02	1.00E-01	1.00E+00	1.00E+01	1.00E+02	1.00E+03		1.00E+00	1.00E+00		
52	9.78E-09	9.90E-08	9.95E-07	9.98E-06	9.99E-05	1.00E-03	1.00E-02	1.00E-01	1.00E+00	1.00E+01	1.00E+02	1.00E+03		1.00E+00	1.00E+00		
53																	
54																	
55																	
56																	
57																	
58																	
59																	
60																	
61																	
62																	
63																	
64																	
65																	
66																	
67																	
68																	
69																	
70																	
71																	
72																	
73																	
74																	

Information Only

	AO	AP	AQ	AR	AS	AT	AU	AV	AW	AX	AY	AZ	BA	BB	BC
1															
2															
3															
4															
5															
6															
7															
8															
9															
10															
11	Type														
12	5	6													
13	NA	INA													
14	NA	INA													
15	NA	INA													
16	NA	INA													
17	NA	INA													
18	NA	INA													
19	0	INA													
20		0	INA												
21	NA	INA													
22	NA	INA													
23	NA	INA													
24	NA	INA													
25	NA	INA													
26		0	INA												
27	NA	INA													
28	NA	INA													
29	NA		0												
30	NA	INA													
31	0	0													
32															
33															
34															
35															
36															
37															
38															
39															
40															
41															
42															
43															
44															
45	CCDF for reduced particle size (v in m3) due to material specific processes effect on radius														
46	1.00E-17	1.00E-16	1.00E-15	1.00E-14	1.00E-13	1.00E-12	1.00E-11	1.00E-10	1.00E-09	1.00E-08	1.00E-07	1.00E-06	1.00E-05	1.00E-04	1.00E-03
47	1.00E+00	1.00E+00	1.00E+00	1.00E+00	1.00E+00	1.00E+00	1.00E+00	1.00E+00	1.00E+00	9.90E-01	9.80E-01	9.67E-01	1.32E-01	1.74E-02	2.29E-03
48	1.00E+00	1.00E+00	1.32E-01	1.74E-02	2.29E-03	3.02E-04	3.98E-05	5.25E-06	6.92E-07	9.12E-08	1.20E-08	1.58E-09	2.06E-10	2.75E-11	3.63E-12
49	1.00E-01	1.00E-02	1.00E-03	1.00E-04	1.00E-05	1.00E-06	1.00E-07	1.00E-08	1.00E-09	1.00E-10	1.00E-11	1.00E-12	1.00E-13	9.99E-15	9.99E-16
50	1.00E+00	1.00E+00	1.00E+00	1.00E+00	1.00E+00	1.00E+00	7.93E-01	8.00E-02	7.55E-03	6.91E-04	6.24E-05	5.59E-06	5.00E-07	4.46E-08	3.98E-09
51	1.00E+00	1.00E+00	1.00E+00	1.00E+00	1.00E+00	1.00E+00	1.00E+00	1.00E+00	1.00E+00	1.00E+00	1.00E+00	9.99E-01	7.51E-01	5.64E-01	3.93E-02
52	1.00E+00	1.00E+00	1.00E+00	1.00E+00	1.00E+00	1.00E+00	1.00E+00	1.00E+00	8.46E-03	0.00E+00	0.00E+00	0.00E+00	0.00E+00	0.00E+00	0.00E+00
53															
54															
55															
56															
57	CCDF for precipitated free particulates (v in m3)														
58	1.00E-17	1.00E-16	1.00E-15	1.00E-14	1.00E-13	1.00E-12	1.00E-11	1.00E-10	1.00E-09	1.00E-08	1.00E-07	1.00E-06	1.00E-05	1.00E-04	1.00E-03
59	1.00E+00	0.00E+00	0.00E+00	0.00E+00	0.00E+00	0.00E+00	0.00E+00	0.00E+00	0.00E+00	0.00E+00	0.00E+00	0.00E+00	0.00E+00	0.00E+00	0.00E+00
60	1.00E+00	0.00E+00	0.00E+00	0.00E+00	0.00E+00	0.00E+00	0.00E+00	0.00E+00	0.00E+00	0.00E+00	0.00E+00	0.00E+00	0.00E+00	0.00E+00	0.00E+00
61	1.00E+00	0.00E+00	0.00E+00	0.00E+00	0.00E+00	0.00E+00	0.00E+00	0.00E+00	0.00E+00	0.00E+00	0.00E+00	0.00E+00	0.00E+00	0.00E+00	0.00E+00
62															
63	8.41E-01	8.25E-01	5.22E-01	4.82E-01	4.77E-01	4.76E-01	4.56E-01	3.86E-01	1.93E-01	1.89E-01	1.88E-01	1.87E-01	7.77E-02	4.97E-02	3.58E-03
64															
65															
66															
67															
68															
69															
70															
71															
72															
73															
74															

	BD	BE	BF	BG	BH	BI	BJ	BK	BL	BM	BN	BO	BP	BQ	BR	
1																
2																
3																
4																
5																
6																
7																
8																
9																
10																
11																
12																
13																
14																
15																
16																
17																
18																
19																
20																
21																
22																
23																
24																
25																
26																
27																
28																
29																
30																
31																
32																
33																
34										3.16E-19	3.16E-18	3.16E-17	3.16E-16	3.16E-15	3.16E-14	3.16E-13
35									0.00E+00	0.00E+00	0.00E+00	0.00E+00	0.00E+00	0.00E+00	0.00E+00	0.00E+00
36									0.00E+00	0.00E+00	0.00E+00	8.68E-01	1.14E-01	1.51E-02	1.99E-03	
37									0.00E+00	9.00E-01	9.00E-02	9.00E-03	9.00E-04	9.00E-05	9.00E-06	
38									0.00E+00	0.00E+00	0.00E+00	0.00E+00	0.00E+00	0.00E+00	0.00E+00	0.00E+00
39									0.00E+00	0.00E+00	0.00E+00	0.00E+00	0.00E+00	0.00E+00	0.00E+00	0.00E+00
40									0.00E+00	0.00E+00	0.00E+00	0.00E+00	0.00E+00	0.00E+00	0.00E+00	0.00E+00
41																
42																
43																
44																
45																
46										hi bound						
47	1.00E-02	1.00E-01	1.00E+00	1.00E+01	1.00E+02	1.00E+03	1.00E+04	%	3.16E-19	3.16E-18	3.16E-17	3.16E-16	3.16E-15	3.16E-14	3.16E-13	
48	3.02E-04	3.98E-05	5.25E-06	6.92E-07	9.12E-08	1.20E-08	0.00E+00	1.06E-01	0.00E+00	0.00E+00	0.00E+00	0.00E+00	0.00E+00	0.00E+00	0.00E+00	0.00E+00
49	4.79E-13	6.31E-14	8.33E-15	1.11E-15	1.11E-16	0.00E+00	0.00E+00	3.47E-01	0.00E+00	0.00E+00	-3.55E-15	8.68E-01	1.14E-01	1.51E-02	1.99E-03	
50	1.11E-18	0.00E+00	0.00E+00	0.00E+00	0.00E+00	0.00E+00	0.00E+00	1.77E-01	0.00E+00	9.00E-01	9.00E-02	9.00E-03	9.00E-04	9.00E-05	9.00E-06	
51	3.55E-10	3.16E-11	2.82E-12	2.51E-13	2.24E-14	2.00E-15	0.00E+00	9.74E-02	0.00E+00	0.00E+00	0.00E+00	0.00E+00	0.00E+00	0.00E+00	0.00E+00	0.00E+00
52	2.78E-03	1.97E-04	1.40E-05	9.89E-07	7.00E-08	4.95E-09	0.00E+00	8.49E-02	0.00E+00	0.00E+00	0.00E+00	0.00E+00	0.00E+00	0.00E+00	0.00E+00	0.00E+00
53	0.00E+00	0.00E+00	0.00E+00	0.00E+00	0.00E+00	0.00E+00	0.00E+00	1.88E-01	0.00E+00	0.00E+00	0.00E+00	0.00E+00	0.00E+00	0.00E+00	0.00E+00	0.00E+00
54								100%								
55																
56																
57																
58										hi bound						
59	1.00E-02	1.00E-01	1.00E+00	1.00E+01	1.00E+02	1.00E+03	1.00E+04	%								
60	0.00E+00	0.00E+00	0.00E+00	0.00E+00	0.00E+00	0.00E+00	0	0%								
61	0.00E+00	0.00E+00	0.00E+00	0.00E+00	0.00E+00	0.00E+00	0	0%								
62	0.00E+00	0.00E+00	0.00E+00	0.00E+00	0.00E+00	0.00E+00	0	0%								
63	2.68E-04	2.09E-05	1.74E-06	1.57E-07	1.56E-08	1.69E-09	0		0.00E+00	1.59E-01	1.59E-02	3.03E-01	3.99E-02	5.25E-03	6.91E-04	
64									raw aggregated	0.00E+00	5.04E-19	5.04E-19	9.57E-17	1.26E-16	1.88E-16	2.19E-16
65									normalized aggregated	0.00E+00	8.49E-15	8.49E-15	1.81E-12	2.12E-12	2.80E-12	3.68E-12
66									raw encapsulated	0.00E+00	7.64E-15	7.64E-15	1.45E-12	1.91E-12	2.52E-12	3.31E-12
67									normalized encapsulated	0.00E+00	7.64E-15	7.64E-15	1.45E-12	1.91E-12	2.52E-12	3.31E-12
68																
69																
70																
71																
72																
73																
74																

Information Only

	BS	BT	BU	BV	BW	BX	BY	BZ	CA	CB	CC	CD	CE	CF	CG
1															
2															
3															
4															
5															
6															
7															
8															
9															
10															
11															
12															
13															
14															
15															
16															
17															
18															
19															
20															
21															
22															
23															
24															
25															
26															
27															
28															
29															
30															
31															
32															
33	frequency of particle sizes (v in m3)														
34	3.16E-12	3.16E-11	3.16E-10	3.16E-09	3.16E-08	3.16E-07	3.16E-06	3.16E-05	0.000316	0.003162	0.031623	0.316228	3.162278	31.62278	316.2278
35	0.00E+00	0.00E+00	0.00E+00	9.85E-03	9.78E-03	9.66E-03	8.39E-01	1.14E-01	1.51E-02	1.99E-03	2.62E-04	3.46E-05	4.56E-06	6.01E-07	7.92E-08
36	2.62E-04	3.46E-05	4.56E-06	6.01E-07	7.92E-08	1.04E-08	1.38E-09	1.81E-10	2.39E-11	3.15E-12	4.16E-13	5.47E-14	7.22E-15	9.99E-16	1.11E-16
37	9.00E-07	9.00E-08	9.00E-09	9.00E-10	9.00E-11	9.00E-12	9.00E-13	9.00E-14	8.99E-15	8.88E-16	1.11E-16	0.00E+00	0.00E+00	0.00E+00	0.00E+00
38	0.00E+00	9.11E-01	8.12E-02	7.24E-03	6.45E-04	5.75E-05	5.12E-06	4.57E-07	4.07E-08	3.63E-09	3.23E-10	2.88E-11	2.57E-12	2.29E-13	2.04E-14
39	0.00E+00	0.00E+00	0.00E+00	0.00E+00	0.00E+00	0.00E+00	2.48E-01	1.87E-01	5.28E-01	3.66E-02	2.59E-03	1.83E-04	1.30E-05	9.18E-07	6.50E-08
40	0.00E+00	0.00E+00	0.00E+00	1.00E+00	0.00E+00	0.00E+00	0.00E+00	0.00E+00	0.00E+00	0.00E+00	0.00E+00	0.00E+00	0.00E+00	0.00E+00	0.00E+00
41															
42															
43															
44															
45	frequency of reduced particle sizes (v in m3)														
46	3.16E-12	3.16E-11	3.16E-10	3.16E-09	3.16E-08	3.16E-07	3.16E-06	3.16E-05	0.000316	0.003162	0.031623	0.316228	3.162278	31.62278	316.2278
47	0.00E+00	0.00E+00	2.07E-04	9.74E-03	9.70E-03	1.37E-02	8.35E-01	1.14E-01	1.51E-02	1.99E-03	2.62E-04	3.46E-05	4.56E-06	6.01E-07	7.92E-08
48	2.62E-04	3.46E-05	4.56E-06	6.01E-07	7.92E-08	1.04E-08	1.38E-09	1.81E-10	2.39E-11	3.15E-12	4.16E-13	5.47E-14	7.22E-15	9.99E-16	1.11E-16
49	9.00E-07	9.00E-08	9.00E-09	9.00E-10	9.00E-11	9.00E-12	9.00E-13	9.00E-14	8.99E-15	8.88E-16	1.11E-16	0.00E+00	0.00E+00	0.00E+00	0.00E+00
50	2.07E-01	7.13E-01	7.24E-02	6.88E-03	6.29E-04	5.68E-05	5.09E-06	4.55E-07	4.06E-08	3.62E-09	3.23E-10	2.88E-11	2.57E-12	2.29E-13	2.04E-14
51	0.00E+00	0.00E+00	0.00E+00	0.00E+00	0.00E+00	5.99E-04	2.48E-01	1.87E-01	5.25E-01	3.65E-02	2.59E-03	1.83E-04	1.30E-05	9.18E-07	6.50E-08
52	0.00E+00	0.00E+00	9.92E-01	8.46E-03	0.00E+00	0.00E+00	0.00E+00	0.00E+00	0.00E+00	0.00E+00	0.00E+00	0.00E+00	0.00E+00	0.00E+00	0.00E+00
53															
54															
55															
56															
57															
58															
59															
60															
61															
62															
63	2.03E-02	6.95E-02	1.94E-01	3.29E-03	1.09E-03	1.50E-03	1.09E-01	2.79E-02	4.61E-02	3.31E-03	2.47E-04	1.92E-05	1.58E-06	1.41E-07	1.39E-08
64	6.41E-14	2.20E-12	8.12E-11	1.04E-11	3.43E-11	4.74E-10	3.45E-07	8.83E-07	1.46E-05	1.05E-05	7.82E-06	6.07E-06	5.00E-06	4.47E-06	4.39E-06
65	1.08E-09	3.70E-08	1.03E-06	1.75E-07	5.78E-07	7.99E-06	5.81E-03	1.49E-02	2.48E-01	1.78E-01	1.32E-01	1.02E-01	8.42E-02	7.53E-02	7.39E-02
66	9.72E-10	3.33E-08	9.28E-07	1.58E-07	5.20E-07	7.19E-06	5.23E-03	1.34E-02	2.21E-01	1.59E-01	1.19E-01	9.20E-02	7.58E-02	6.77E-02	6.65E-02
67	9.72E-10	3.33E-08	9.28E-07	1.58E-07	5.20E-07	7.19E-06	5.23E-03	1.34E-02	2.21E-01	1.59E-01	1.19E-01	9.20E-02	7.58E-02	6.77E-02	6.65E-02
68															
69															
70															
71															
72															
73															
74															

	CH	CI	CJ
1			
2			
3			
4			
5			
6			
7			
8			
9			
10			
11			
12			
13			
14			
15			
16			
17			
18			
19			
20			
21			
22			
23			
24			
25			
26			
27			
28			
29			
30			
31			
32			
33			
34	3162.278	$\Sigma_v P_v$	
35	1.20E-08	0.000133	
36	0.00E+00	1.6E-13	
37	0.00E+00	4.9E-17	
38	2.00E-15	2.16E-10	
39	4.95E-09	0.000535	
40	0.00E+00	3.16E-09	
41			
42			
43			
44			
45			
46	3162.278	$\Sigma_v P_v$	$\Sigma_v I$
47	1.20E-08	1.33E-04	1.00E+00
48	0.00E+00	1.60E-13	1.00E+00
49	0.00E+00	4.90E-17	1.00E+00
50	2.00E-15	2.08E-10	1.00E+00
51	4.95E-09	5.34E-04	1.00E+00
52	0.00E+00	3.40E-10	1.00E+00
53			
54			
55			
56			
57			
58			
59			
60			
61			
62			
63	1.69E-09	5.94E-05	1.00E+00
64	5.34E-06	1.84E-02	5.94E-05
65	8.99E-02	3.10E+02	1.00E+00
66	8.09E-02	2.79E+02	9.00E-01
67	8.09E-02	2.83E+02	1.00E+00
68			
69			
70			
71			
72			
73			
74			



Inadvertent intrusion characteristics at random area location																				
Time of interest (years)	2000																			
Scale of interest (m ³) ^a	1																			
Vertical location ("top" or "room") ^a	top																			
Predicted repository conditions at time, scale and location of interest		% remain ^b	Δradius (m) ^b																	
Corrosion of Fe&Al-base metals		50%	1.00E-05																	
Biodegradation of cellulose/solid organics		90%	0.0																	
Biodegradation of rubber/plastics		50%	0.0																	
Dissolution of MgO backfill		50%	1.00E-06																	
		% volume ^c																		
Waste porosity ^b		20%																		
Salt precipitation ^b		10%																		
Salt encapsulation ^b		10%																		
Notes:																				
^a Although time, scale and vertical location of interest are specified, they are not currently variables in the model.																				
^b % remaining and Δradius for each process, waste porosity, salt precipitation and salt encapsulation are related and are specified by PA as a function of time (cell B2), considering coupled processes of creep, brine inflow, corrosion, dissolution, precipitation, biodegradation and gas generation.																				
These parameters may be variable and uncertain for random location, correlated among locations and with each other, and function of specified scale and room location (cells B3 and B4).																				
^c % is relative to volume after room closure has occurred (i.e., not % of original room volume).																				

M

reduced size	0.00E+00	0.00E+00	0.00E+00	0.00E+00	1.60E-18	2.78E-14	5.90E-13	7.92E-12	8.99E-11	9.52E-10	9.78E-09	8.90E-08	9.95E-07	9.98E-06	9.99E-05	1.00E-03	1.00E-02	1.00E-01	1.00E+00	1.00E+01	1.00E+02	1.00E+03	1.00E+04	1.00E+05
CCDF	1.00E+00	1.00E+00	1.00E+00	1.00E+00	1.00E+00	1.00E+00	1.00E+00	1.00E+00	1.00E+00	1.00E+00	9.90E-01	9.80E-01	9.71E-01	1.32E-01	1.74E-02	2.29E-03	3.02E-04	3.98E-05	5.25E-06	6.92E-07	9.12E-08	1.20E-08	0.00E+00	0.00E+00
reduced size	1.00E-18	1.00E-17	1.00E-16	1.00E-15	1.00E-14	1.00E-13	1.00E-12	1.00E-11	1.00E-10	1.00E-09	1.00E-08	1.00E-07	1.00E-06	1.00E-05	1.00E-04	1.00E-03	1.00E-02	1.00E-01	1.00E+00	1.00E+01	1.00E+02	1.00E+03		
lower value	4	4	4	5	5	6	7	8	9	10	11	12	13	14	15	18	17	18	19	20	21	22		
with interp CCDF	1	1	1	1	1	1	1	1	1	1	0.999489	0.90551	0.820258	0.739575	1.58E-09	2.51E-10	3.98E-27	8.31E-38	1E-44	1.58E-53	2.91E-62	3.98E-71	8.31E-80	
log interp CCDF	1	1	1	1	1	1	1	1	1	1	0.999793	0.990052	0.980348	0.966673	0.131566	0.017382	0.00229	0.000302	3.98E-05	5.25E-06	6.92E-07	9.12E-08	1.2E-08	

M

Group2

reduced size	1.00E-18	1.00E-17	1.00E-16	1.00E-15	1.00E-14	1.00E-13	1.00E-12	1.00E-11	1.00E-10	1.00E-09	1.00E-08	1.00E-07	1.00E-06	1.00E-05	1.00E-04	1.00E-03	1.00E-02	1.00E-01	1.00E+00	1.00E+01	1.00E+02	1.00E+03	1.00E+04
CCDF	1.00E+00	1.00E+00	1.00E+00	1.32E-01	1.74E-02	2.28E-03	3.02E-04	3.98E-05	5.25E-06	6.92E-07	9.12E-08	1.20E-08	1.58E-09	2.09E-10	2.75E-11	3.63E-12	4.79E-13	6.31E-14	8.33E-15	1.11E-15	1.11E-16	0.00E+00	0.00E+00
reduced size	1.00E-18	1.00E-17	1.00E-16	1.00E-15	1.00E-14	1.00E-13	1.00E-12	1.00E-11	1.00E-10	1.00E-09	1.00E-08	1.00E-07	1.00E-06	1.00E-05	1.00E-04	1.00E-03	1.00E-02	1.00E-01	1.00E+00	1.00E+01	1.00E+02	1.00E+03	
lower value	1	2	3	4	5	6	7	8	9	10	11	12	13	14	15	16	17	18	19	20	21	22	
arith interp CCDF	1	1	1	1.6E-09	2.5E-18	4E-27	6.3E-36	1E-44	1.6E-53	2.5E-62	4E-71	6.3E-80	1E-88	1.6E-97	3E-106	4E-115	6E-124	1E-132	2E-141	3E-150	3E-160	0	
log interp CCDF	1	1	1	0.13183	0.01738	0.00229	0.0003	4E-05	5.2E-06	6.9E-07	9.1E-08	1.2E-08	1.6E-09	2.1E-10	2.8E-11	3.6E-12	4.6E-13	6.3E-14	8.3E-15	1.1E-15	1.1E-16	0	

12

reduced size	1.00E-16	1.00E-17	1.00E-16	1.00E-15	1.00E-14	1.00E-13	1.00E-12	1.00E-11	1.00E-10	1.00E-09	1.00E-08	1.00E-07	1.00E-06	1.00E-05	1.00E-04	1.00E-03	1.00E-02	1.00E-01	1.00E+00	1.00E+01	1.00E+02	1.00E+03	1.00E+04
CCDF	1.00E+00	1.00E-01	1.00E-02	1.00E-03	1.00E-04	1.00E-05	1.00E-06	1.00E-07	1.00E-08	1.00E-09	1.00E-10	1.00E-11	1.00E-12	1.00E-13	9.99E-15	9.99E-16	1.11E-16	0.00E+00	0.00E+00	0.00E+00	0.00E+00	0.00E+00	0.00E+00
reduced size	1.00E-18	1.00E-17	1.00E-16	1.00E-15	1.00E-14	1.60E-13	1.00E-12	1.00E-11	1.00E-10	1.00E-09	1.00E-08	1.00E-07	1.00E-06	1.00E-05	1.00E-04	1.00E-03	1.00E-02	1.00E-01	1.00E+00	1.00E+01	1.00E+02	1.00E+03	
lower value	1	2	3	4	5	6	7	8	9	10	11	12	13	14	15	16	17	18	19	20	21	22	
arith interp CCDF	1	1E-10	1E-20	1E-30	1E-40	1E-50	1E-60	1E-70	1E-80	1E-90	1E-100	1E-110	1E-120	1E-130	1E-140	1E-150	3E-160	0	0	0	0	0	0
log interp CCDF	1	0.1	0.01	0.001	1E-04	1E-05	1E-06	1E-07	1E-08	1E-09	1E-10	1E-11	1E-12	1E-13	1E-14	1E-15	1.1E-16	0	0	0	0	0	0



Group4

reduced size	0.00E+00	0.00E+00	0.00E+00	0.00E+00	1.60E-16	2.78E-14	5.90E-13	7.92E-12	8.99E-11	9.52E-10	9.78E-09	9.90E-08	9.95E-07	9.98E-06	9.99E-05	1.00E-03	1.00E-02	1.00E-01	1.00E+00	1.00E+01	1.00E+02	1.00E+03	1.00E+04
CCDF	1.00E+00	1.00E+00	1.00E+00	1.00E+00	1.00E+00	1.00E+00	1.00E+00	1.00E+00	8.91E-02	7.84E-03	7.08E-04	6.31E-05	5.62E-06	5.01E-07	4.47E-08	3.98E-09	3.55E-10	3.16E-11	2.82E-12	2.51E-13	2.24E-14	2.00E-15	0.00E+00
reduced size	1.00E-18	1.00E-17	1.00E-16	1.00E-15	1.00E-14	1.00E-13	1.00E-12	1.00E-11	1.00E-10	1.00E-09	1.00E-08	1.00E-07	1.00E-06	1.00E-05	1.00E-04	1.00E-03	1.00E-02	1.00E-01	1.00E+00	1.00E+01	1.00E+02	1.00E+03	
lower value	4	4	4	5	5	6	7	8	9	10	11	12	13	14	15	16	17	18	19	20	21	22	
arith interp CCDF	1	1	1	1	1	1	1	0.79151	2.8E-11	9.5E-22	3.1E-32	9.9E-43	3.1E-53	1E-63	3.2E-74	1E-84	3.2E-95	1E-105	3E-116	1E-126	3E-137	1E-147	
log interp CCDF	1	1	1	1	1	1	1	0.78283	0.07995	0.00755	0.00069	6.2E-05	5.6E-06	5E-07	4.5E-08	4E-09	3.5E-10	3.2E-11	2.8E-12	2.5E-13	2.2E-14	2E-15	



Group5

reduced size	0.00E+00	0.00E+00	0.00E+00	0.00E+00	1.60E-16	2.78E-14	5.90E-13	7.92E-12	8.99E-11	9.52E-10	9.78E-09	8.90E-08	9.95E-07	9.88E-06	9.99E-05	1.00E-03	1.00E-02	1.00E-01	1.00E+00	1.00E+01	1.00E+02	1.00E+03	1.00E+04
CCDF	1.00E+00	1.00E+00	1.00E+00	1.00E+00	1.00E+00	1.00E+00	1.00E+00	1.00E+00	1.00E+00	1.00E+00	1.00E+00	1.00E+00	1.00E+00	7.52E-01	5.65E-01	3.83E-02	2.79E-03	1.97E-04	1.40E-05	9.88E-07	7.00E-08	4.95E-09	0.00E+00
reduced size	1.00E-18	1.00E-17	1.00E-16	1.00E-15	1.00E-14	1.00E-13	1.00E-12	1.00E-11	1.00E-10	1.00E-09	1.00E-08	1.00E-07	1.00E-06	1.00E-05	1.00E-04	1.00E-03	1.00E-02	1.00E-01	1.00E+00	1.00E+01	1.00E+02	1.00E+03	
lower value	4	4	4	5	5	6	7	8	9	10	11	12	13	14	15	16	17	18	19	20	21	22	
with interp CCDF	1	1	1	1	1	1	1	1	1	1	1	1	1	0.99867	0.06751	0.00331	8.9E-15	2.8E-26	8.9E-38	2.8E-49	8.9E-61	2.8E-72	8.9E-84
log interp CCDF	1	1	1	1	1	1	1	1	1	1	1	1	1	0.9994	0.75141	0.56426	0.03932	0.00278	0.0002	1.4E-05	8.9E-07	7E-08	5E-09



Group6

reduced size	0.00E+00	0.00E+00	0.00E+00	0.00E+00	1.60E-16	2.78E-14	5.90E-13	7.92E-12	8.99E-11	9.52E-10	9.78E-09	9.90E-08	9.95E-07	9.98E-06	9.99E-05	1.00E-03	1.00E-02	1.00E-01	1.00E+00	1.00E+01	1.00E+02	1.00E+03	1.00E+04
CCDF	1.00E+00	1.00E+00	1.00E+00	1.00E+00	1.00E+00	1.00E+00	1.00E+00	1.00E+00	1.00E+00	1.00E+00	1.00E+00	1.00E+00	1.00E+00	1.00E+00	1.00E+00	1.00E+00	1.00E+00	1.00E+00	1.00E+00	1.00E+00	1.00E+00	1.00E+00	1.00E+00
reduced size	1.00E-18	1.00E-17	1.00E-16	1.00E-15	1.00E-14	1.00E-13	1.00E-12	1.00E-11	1.00E-10	1.00E-09	1.00E-08	1.00E-07	1.00E-06	1.00E-05	1.00E-04	1.00E-03	1.00E-02	1.00E-01	1.00E+00	1.00E+01	1.00E+02	1.00E+03	
lower value	4	4	4	5	5	6	7	8	9	10	11	12	13	14	15	16	17	18	19	20	21	22	
with interp CCDF	1	1	1	1	1	1	1	1	1	0.94737	0	0	0	0	0	0	0	0	0	0	0	0	0
log interp CCDF	1	1	1	1	1	1	1	1	1	0.00846	0	0	0	0	0	0	0	0	0	0	0	0	0



Best Copy Available

**APPENDIX C
PARAMETER ASSESSMENTS**

Information Only

The undersigned agree that the following set of viewgraphs adequately represent their judgements, as developed in open meetings held in Carlsbad, NM, on May 5-9, 1997. Additional detail is contained in the transcripts of those meetings, which are available in the project file.

Patrick Doman

Michael P. Gross

(M)

Paul B. LaPorte

Paul C. Lutz

R. J. Minton

I. S. J. Minton

Elicitation Structuring

- Definition of *issue(s)*
- Definitions of *variability* and *uncertainty* in particle sizes
- Definition of *types of effects* on particle sizes
- Description of initial *waste inventory* characteristics
- Description of *processes* affecting particle sizes
- Description of *effects* of processes on particle sizes
- Abstraction of above in *Decomposition Model*

Technical Issue Definition

What is the *conditional probability distribution* for the waste particle diameter frequency distribution (i.e., % of particles exceeding a particular size) at a random areal location, but at a specified vertical location in the waste room, time and scale, given the initial waste inventory and the predicted extent of each relevant process at that location, time and scale?

- just prior to an inadvertent human intrusion
- after tensile failure during spalling event

Limitation

- Radioactivity associated with particles is important to determine release and exposure
- This is outside the scope of this elicitation
- Conditional probability distributions for radioactivity as a function of particle size and possibly time could subsequently be developed and applied
- If radioactivity is approximately independent of particle size, it could simply be apportioned

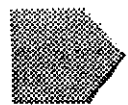

Definition of Waste Particle

Waste Particle

- individual piece or aggregated collection of pieces with significant internal strength (e.g., uniaxial tensile strength > 20psi)
- particles are much more likely to separate from each other, rather than to break up into smaller pieces



Definition of Particle "Diameter"

Equivalent particle diameter (d) =
diameter of sphere with volume (v) equivalent
to individual "particle" $v = \pi d^3 / 6$

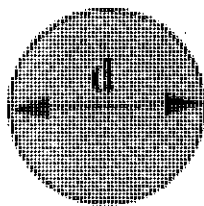

spheres

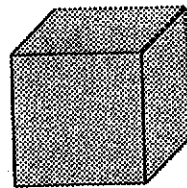
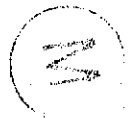

blocks (3D)

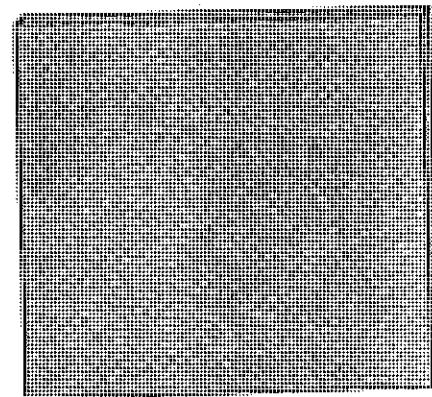

plates (2D)



rods (1D)



Population of Waste Particle Diameters

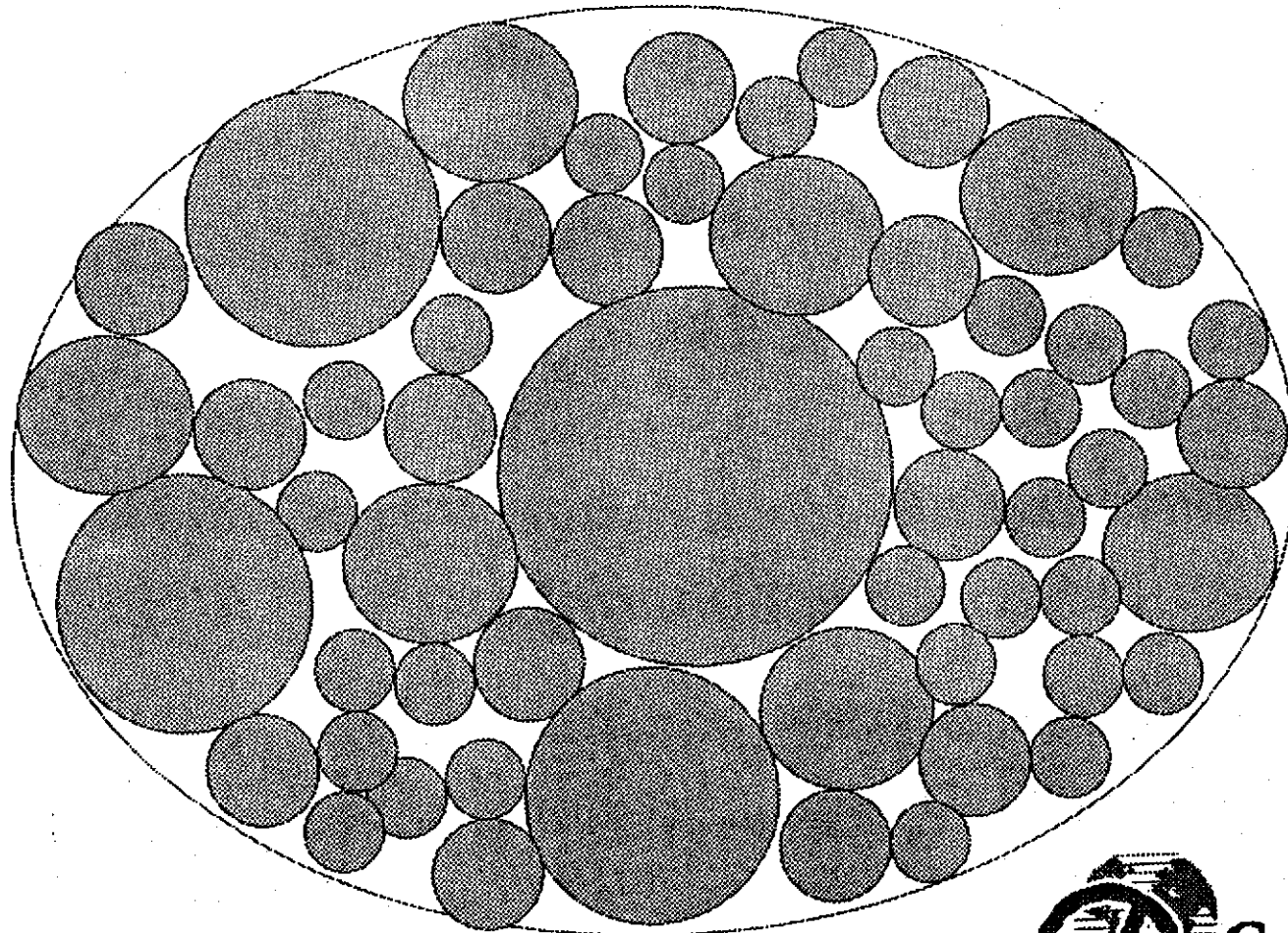

Statistical Description of Population of Waste Particle Diameters

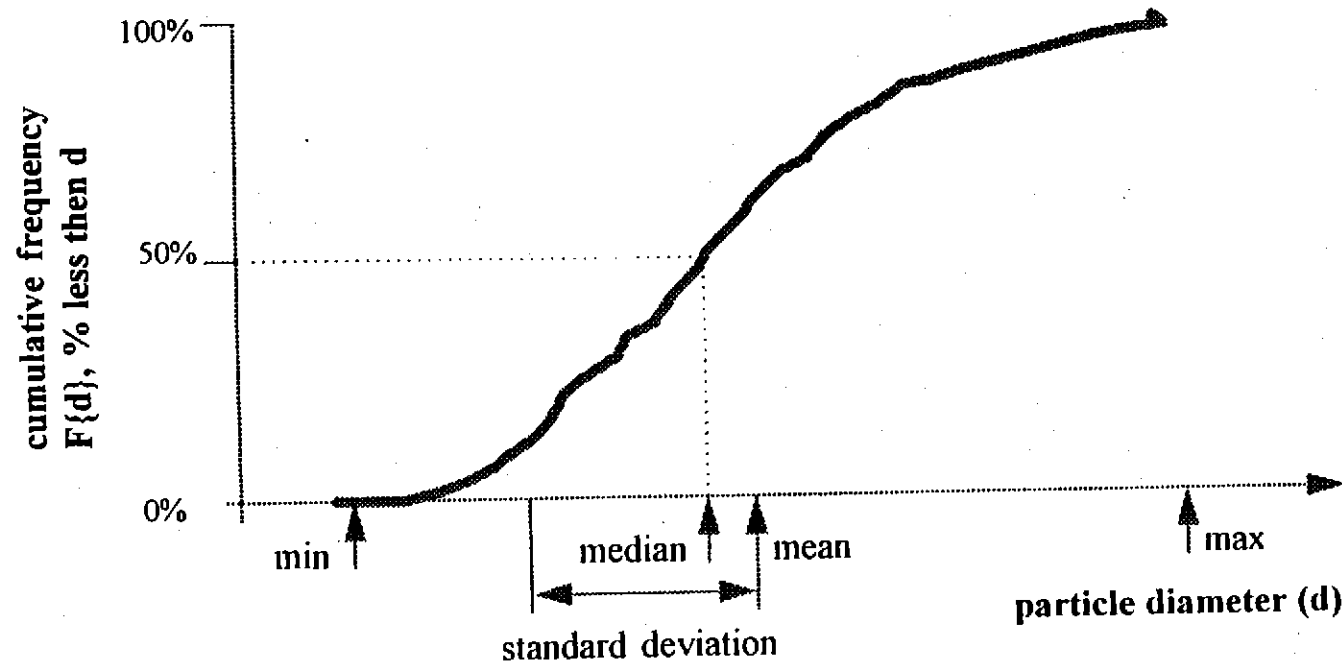

Possible Descriptors:

- minimum value{d}, maximum value{d}
- $F\{d=10^{-3}\}$, $F\{d=10^{-2}\}$, $F\{d=10^{-1}\}$, $F\{d=10^0\}$, $F\{d=10^1\}$, $F\{d=10^2\}$, $F\{d=10^3\}$
- d_{10} , d_{33} , d_{50} , d_{67} , d_{90}
- most common value{d}
- distribution form(e.g., lognormal) and characteristics (e.g., mean and standard deviation)

Variability of Waste Particle Size Populations as a Function of Scale

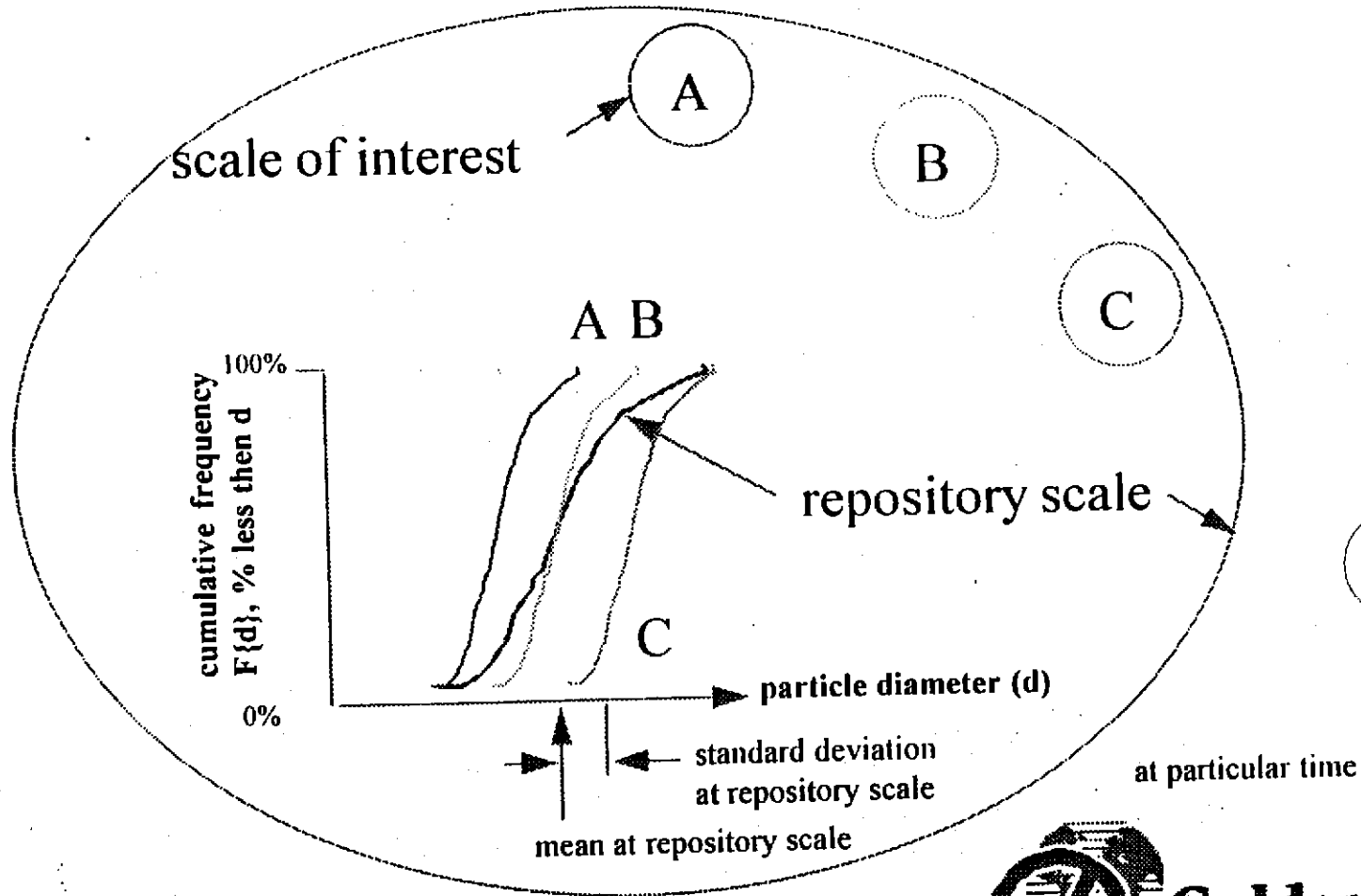

Uncertainty in Specific Population of Waste Particle Diameters

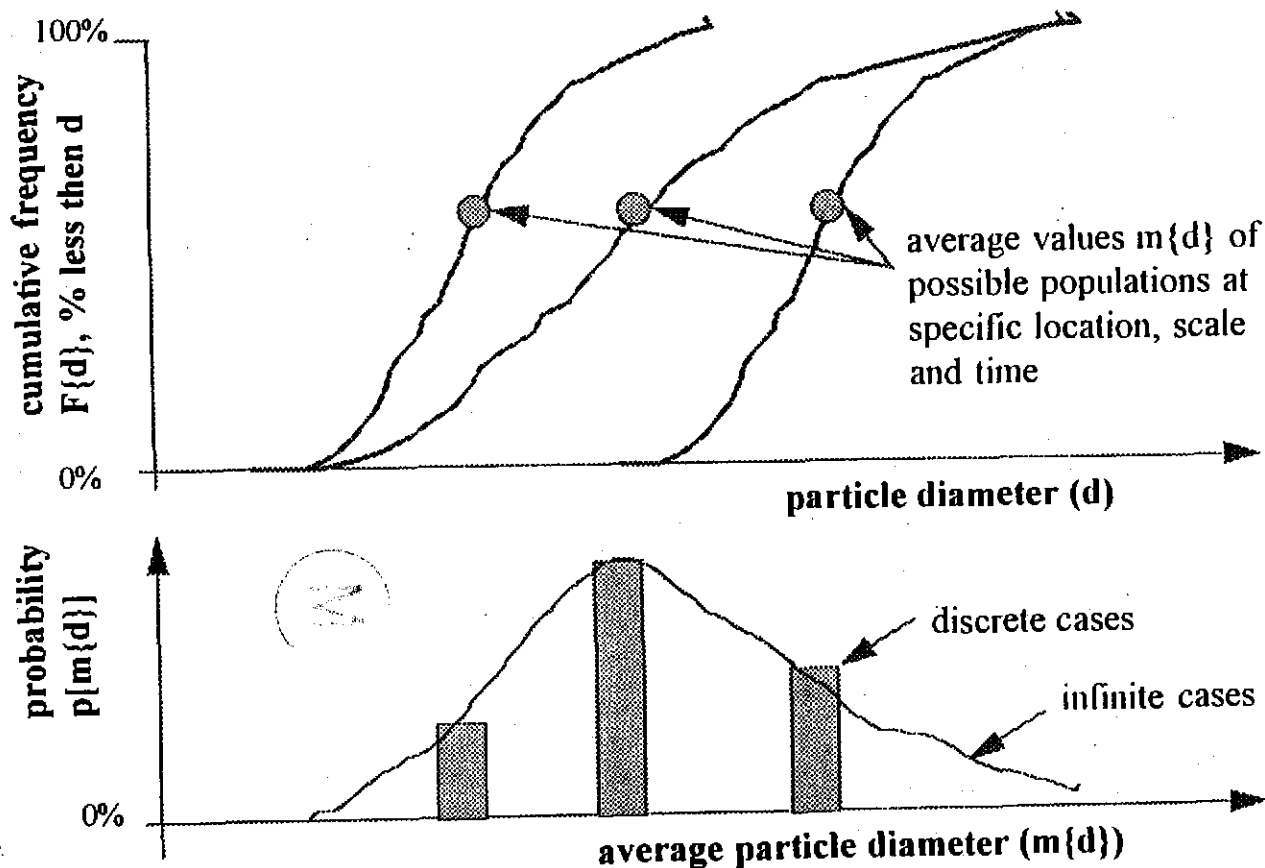

Note: could use other descriptors besides average

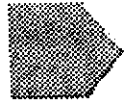

Spatial Correlation in Particle Size Populations

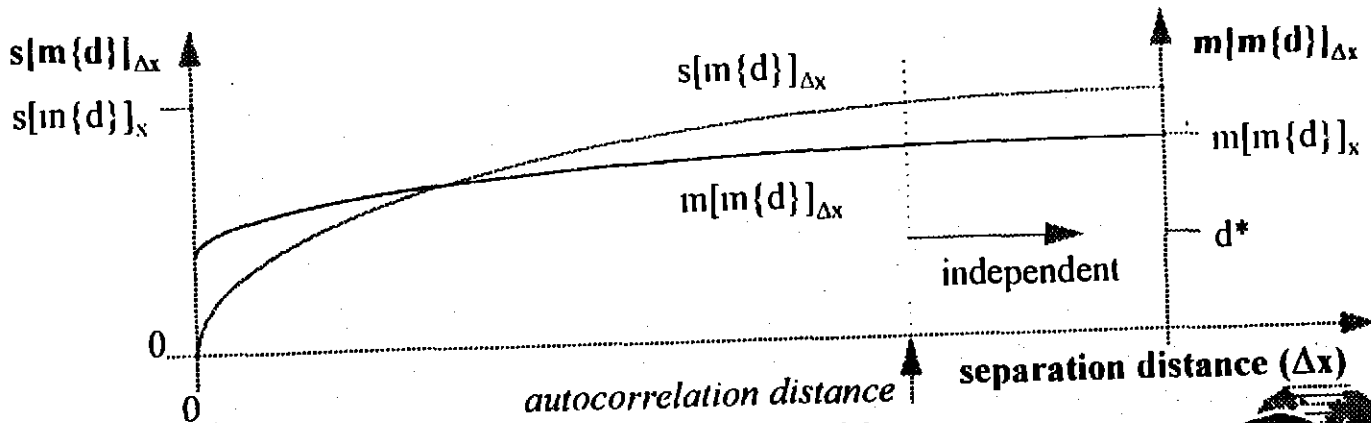
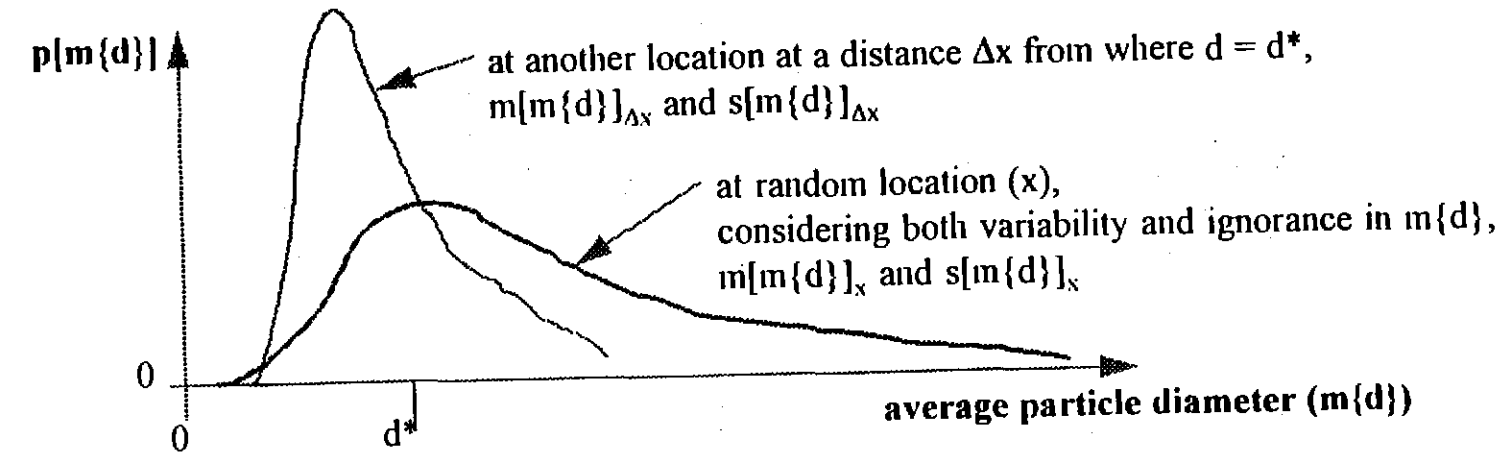

Note: could use other descriptors besides average; at specific time and scale

PR3 1930.301/63487.ppt



Variability of Waste Particle Size Populations as a Function of Scale

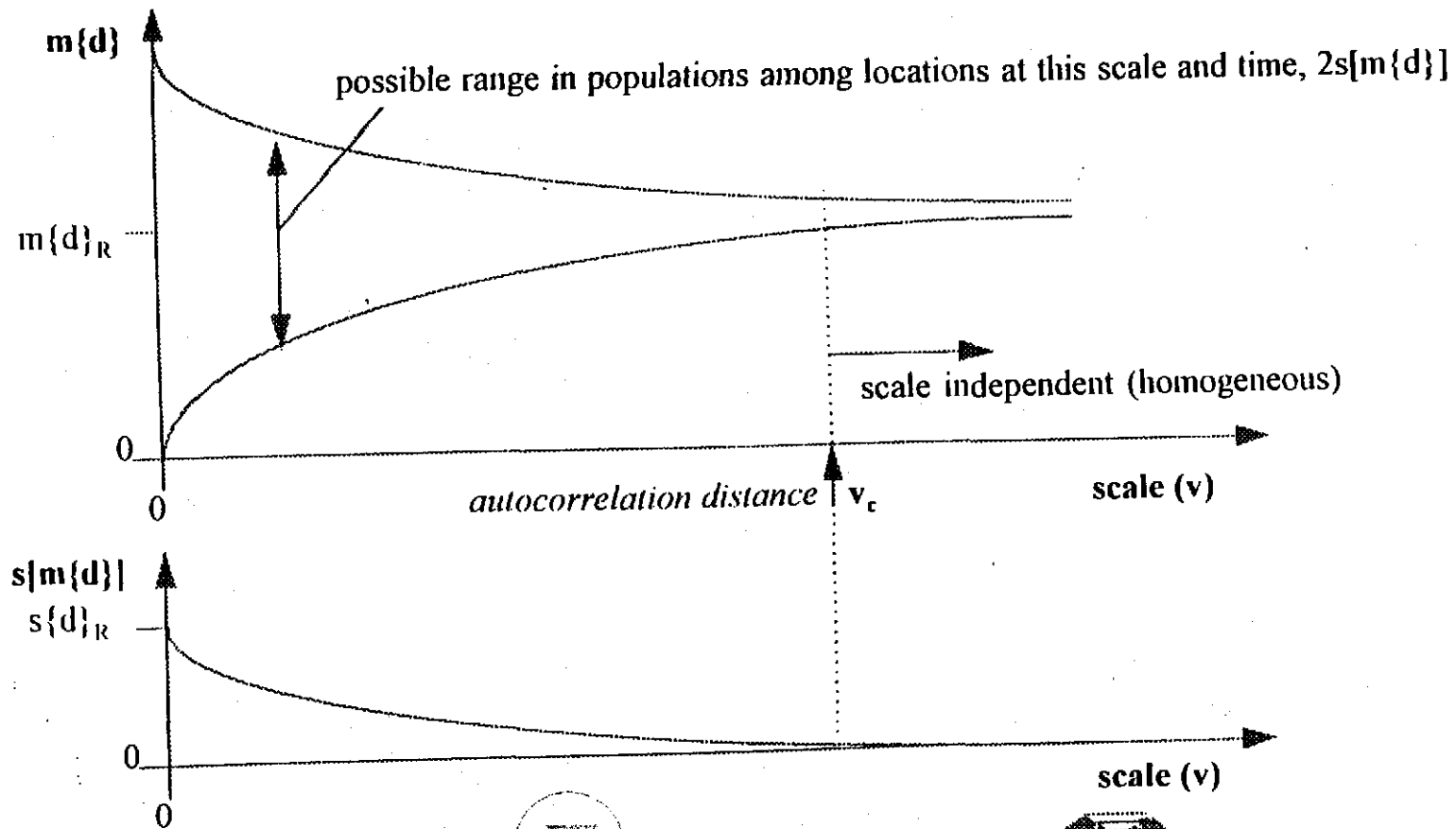

➤ Variability+Ignorance Description of Particle Diameter Populations

$p[f\{d\}_v]$ at random areal location, but at specified vertical location, time (t) and scale (v), e.g.,

$p[m\{d\}_R, s\{d\}_R]$ determined from:

$p[d]_R$ for random particle at that vertical location in repository at time t, e.g., $m[d]_R$ & $s[d]_R$
variability + ignorance

$p[s\{d\}_R/s[d]_R]$ and $p[s\{d\}_S/s[d]_S]$ for population in repository and in small volumes, respectively, at time t
variability vs. ignorance

$p[v_c]$, *critical scale=f{autocorrelation distance}*



Effects of Processes on Particle Size Population

■ *Pervasive reduction*

- corrosion
- biodegradation
- dissolution

■ *Selective reduction*

- crushing
- fragmentation

■ *Aggregation*

- consolidation/encapsulation
- precipitation/cementation

Example - Initial Distribution

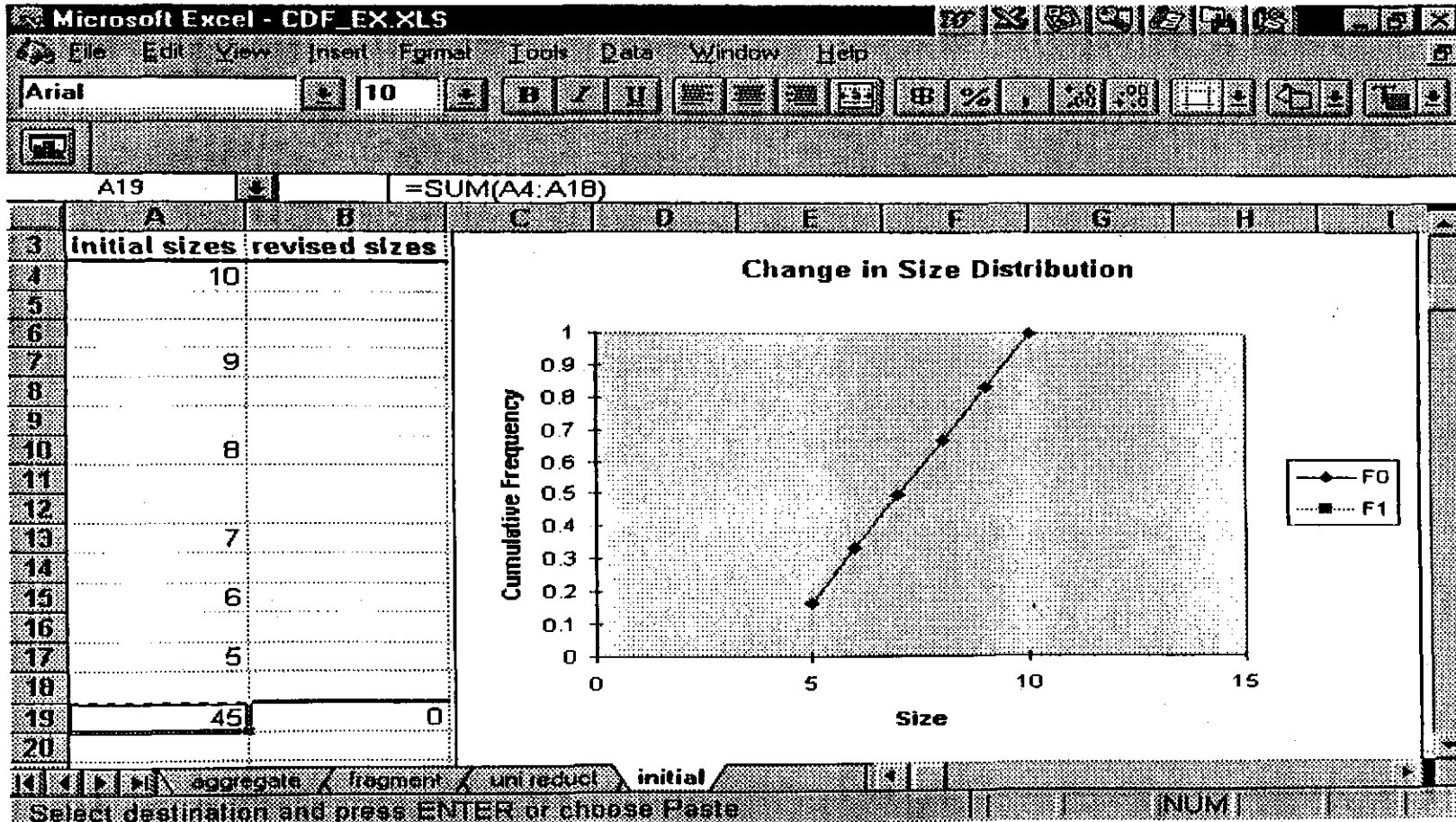

Example - Pervasive Reduction

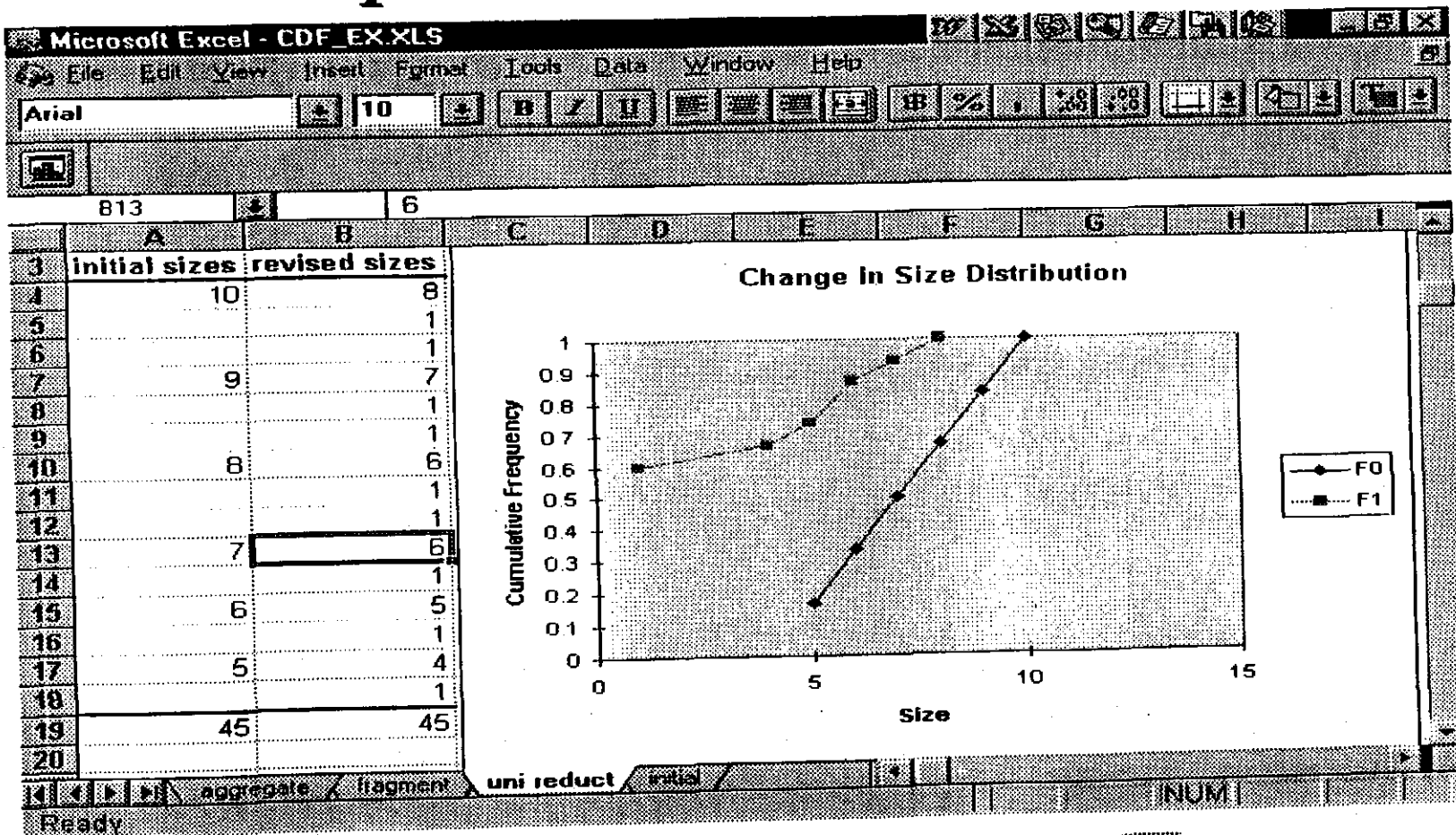

Example - Selected Reduction

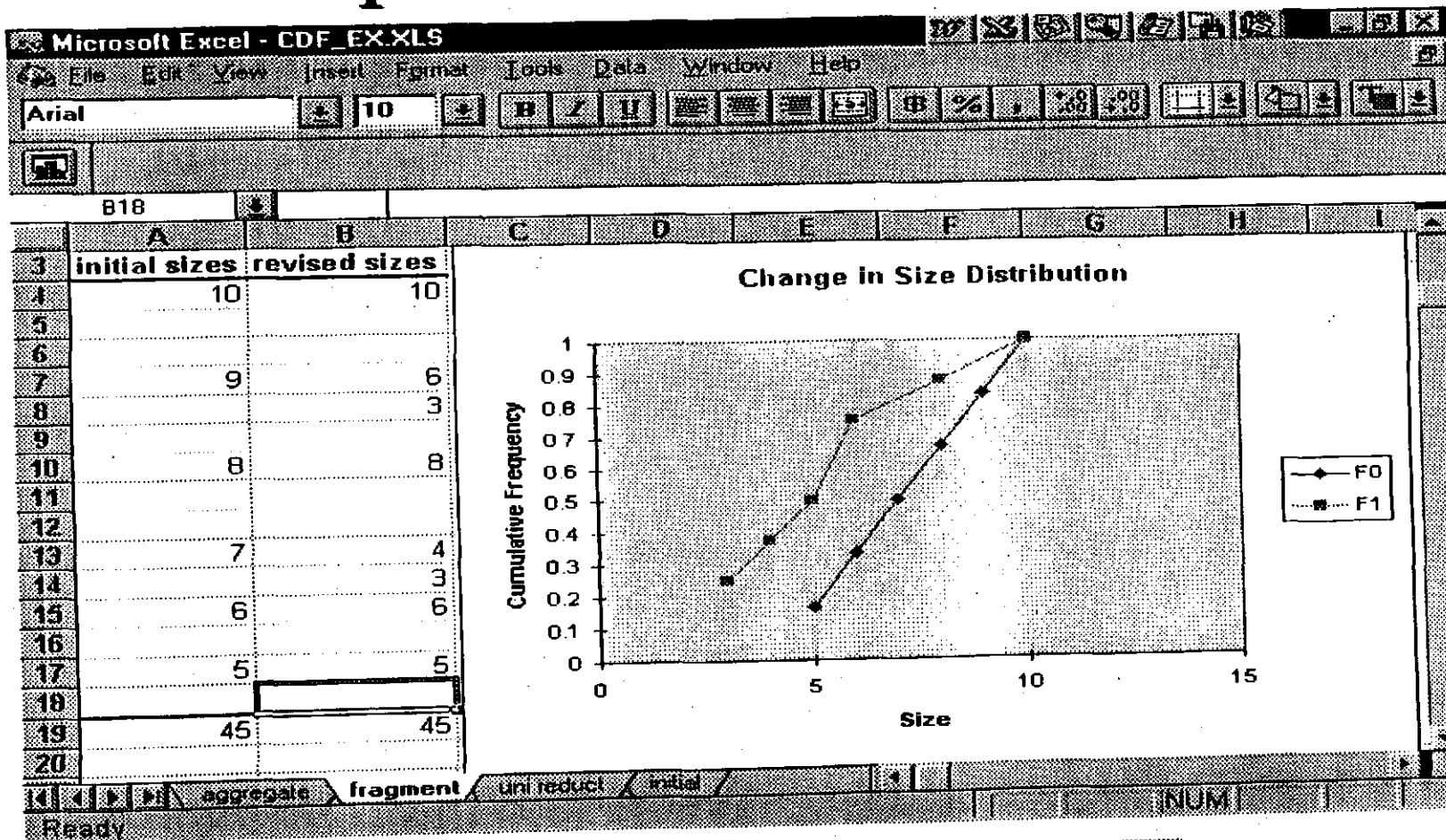

2

Example - Aggregation

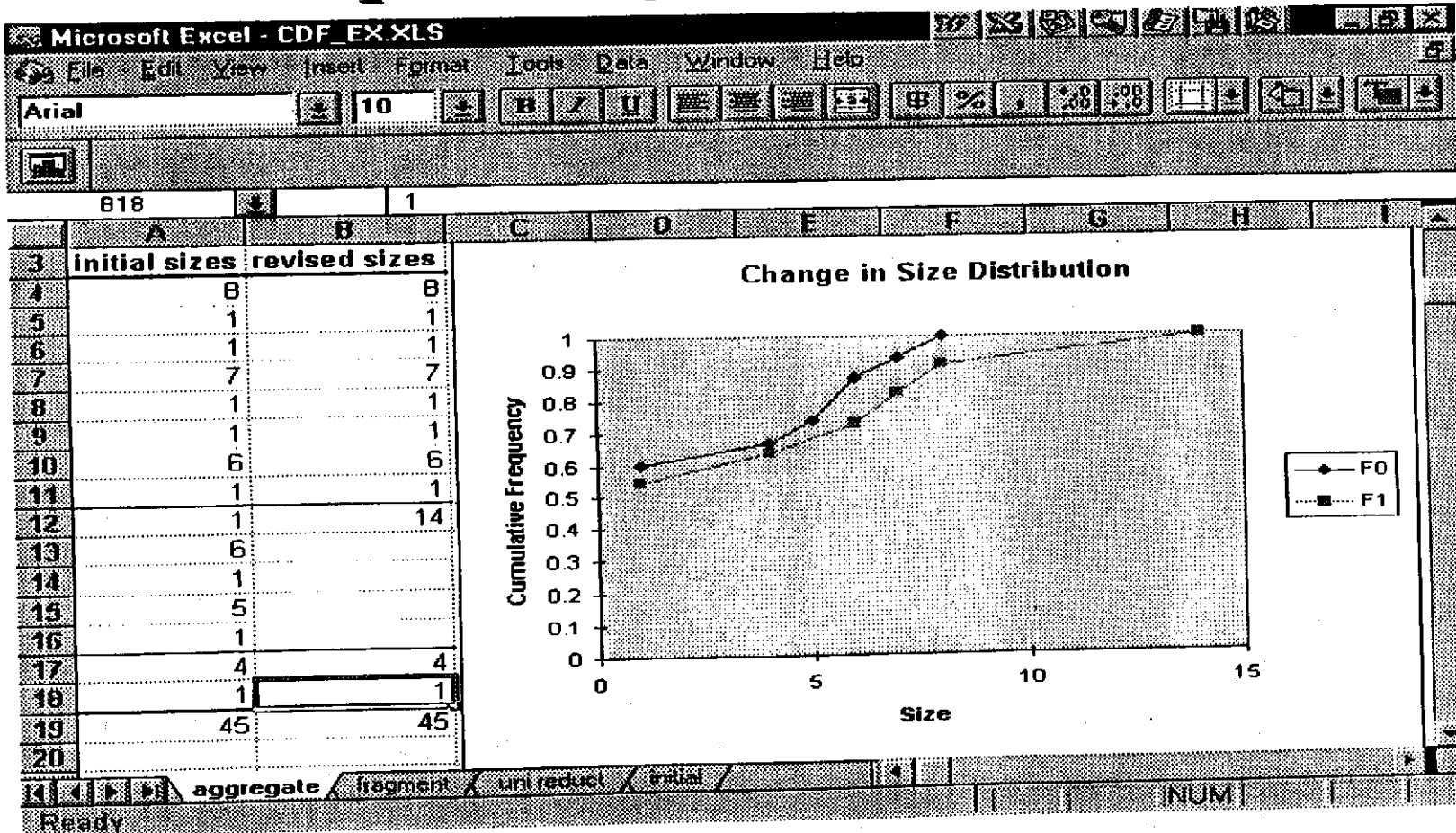

M



Worksheet



Influence Diagram for Particle Size Distribution

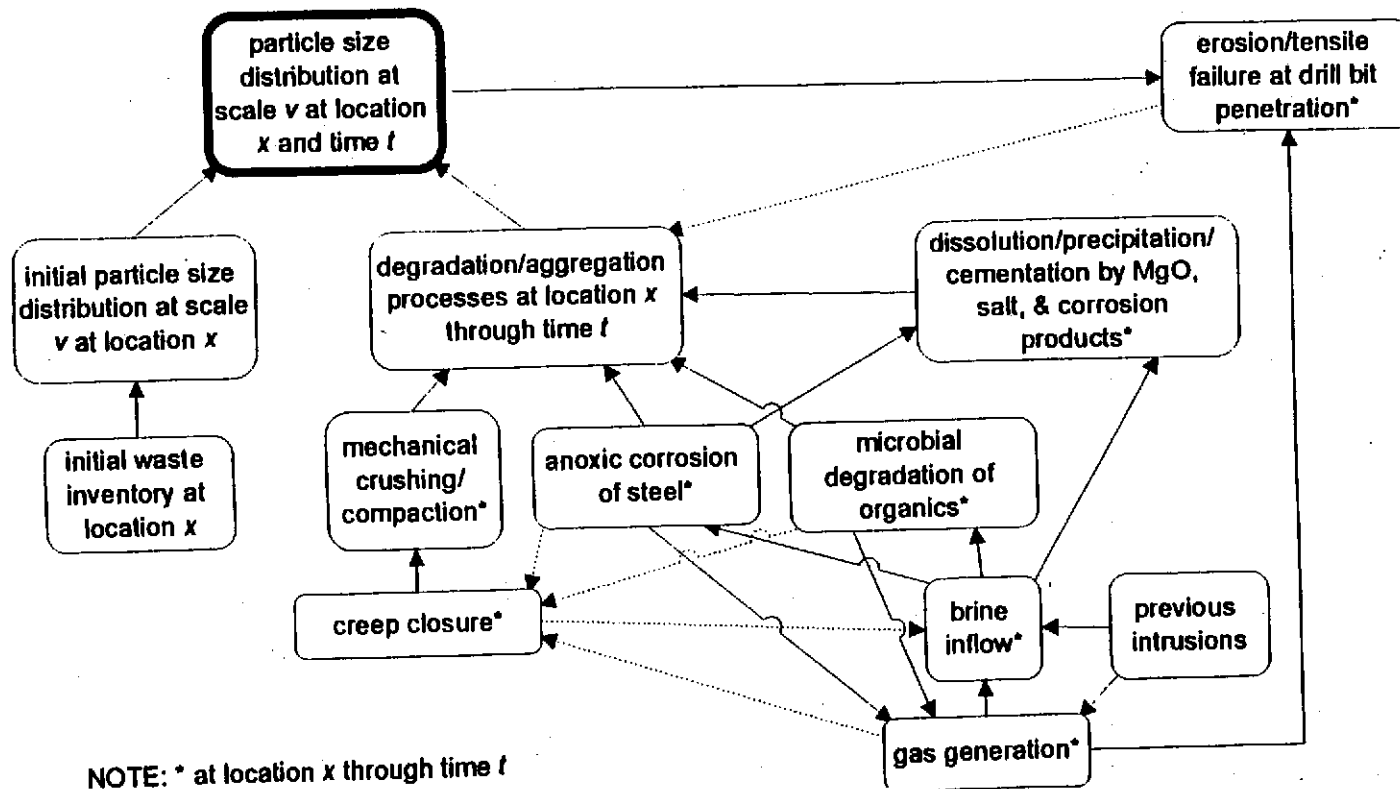

Note: brine inflow implies brine volume,
and gas generation implies gas pressure

PR3 1930.301/63487.ppt



Materials (1 of 6)

■ *iron-base metal/alloys*

- includes iron and steel alloys in the waste, and iron-base metallic phase associated with vitrification; mixed throughout repository; steel and steel plug are considered separately.

■ *aluminum-base metal/alloys*

- includes aluminum or aluminum-base alloys in waste materials; mixed throughout repository.

■ *other metal/alloys*

- includes all other metals found in waste materials, e.g., copper, lead, zirconium, tantalum, lead portion of lead rubber glove/aprons, etc.; mixed throughout repository; lead packaging is considered separately.

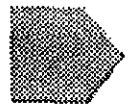

Materials (2 of 6)

■ *other inorganic materials*

- includes **inorganic non-metal waste materials**, e.g., concrete, glass, firebrick, ceramics, graphite, sand, and inorganic sorbents; mixed throughout repository.

■ *vitrified*

- includes waste that has been melted or fused at high temperature with glass forming additives (e.g., soil or silica) in appropriate proportions to result in a homogeneous glass-like matrix; in 7-packs; any unoxidized metallic phases are considered as iron-base metal/alloys.

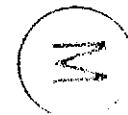

Materials (3 of 6)

■ *cellulosics*

- includes materials generally derived from high polymer plant carbohydrates, e.g., paper, cardboard, kimwipes, wood, cellophane, cloth, etc.; mixed throughout repository

■ *rubber*

- includes natural or manmade elastic latex materials, e.g., Hypalon, neoprene, surgeons' gloves, rubber part of leaded-rubber gloves, etc.; mixed throughout repository

■ *plastics*

- includes generally manmade materials, often derived from petroleum feedstock, e.g., polyethylene, polyvinylchloride, Lucite, Teflon, etc.; plastic packaging is considered separately; mixed throughout repository.





Materials (4 of 6)

■ *solidified inorganic materials*

- includes any homogeneous materials consisting of sludge or aqueous base liquids that are solidified with cement, Envirostone, or other solidification agents, e.g., wastewater treatment sludge, cemented aqueous liquids, and inorganic particulates, etc.; in 7-packs; cement used as part of solidification process is considered separately.

■ *solidified organic material*

- includes cemented organic resins, solidified organic liquids, and sludges; in 7-packs.

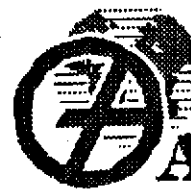

**Golder
Associates**

Materials (5 of 6)

■ *cement (solidified)*

- includes cement used in solidifying liquids, particulates, and sludges; mixed throughout repository.

■ *soils*

- includes generally naturally occurring soils contaminated with inorganic radioactive waste materials; in 7-packs.

■ *steel packaging*

- include containers (e.g., drums, boxes, etc.); in all drums; steel in waste and steel plug packaging are considered separately.

■ *plastics packaging*

- in all drums; plastics in waste are considered separately



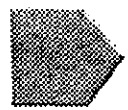

Materials (6 of 6)

■ *lead packaging*

- includes lead shielding in a RH-TRU canister; located in room walls; lead in waste is considered separately.

■ *steel plug*

- located in room walls; steel in waste and steel non-plug packaging are considered separately.

■ *MgO backfill*

- includes pellets, primarily on top and sides of waste room.

■ *Salt*

- fragments from roof, primarily near the roof



Initial Material Properties

Material	Expected Amount (% Total Wt in Repository)	Location
iron-base metal/alloys	12.6	throughout
aluminum-base metal/alloys	1.3	throughout
other metal/alloys	5.6	throughout
other inorganic materials	2.4	throughout
vitrified	4.0	in 7-packs
cellulosics	4.0	throughout
rubber	0.7	throughout
plastics	2.5	throughout
solidified inorganic materials	4.0	in 7-packs
solidified organic material	0.4	in 7-packs
cement (solidified)	3.7	throughout
soils	3.2	in 7-packs
steel packaging	11.4	all drums
plastics packaging	1.9	all drums
lead packaging	1.4	with RH in room walls
steel plug	6.5	with RH in room walls
MgO backfill	34.5	top and sides of room
salt	Note	top of room

Note: Salt fragments have been assessed to comprise about 2% of the original volume of each waste room. Also, amounts of each material will vary among locations as a function of scale, and will not be average except at large scale.



Possible Degradation Processes

- ***Corrosion*** of iron-base and aluminum-base materials due to brine inflow - pervasive reduction of $F\{d\}$ with some particulate byproducts
- ***Biodegradation*** of organic materials, affected by brine inflow - pervasive reduction of $F\{d\}$ without particulate byproducts
- ***Dissolution*** of soluble materials due to brine inflow - pervasive reduction of $F\{d\}$ with some particulate byproducts



Possible Degradation Processes

- ***Crushing*** of friable materials due to room closure - selective reduction of $F\{d\}$; =initial conditions
- ***Compaction*** of all materials due to room closure - insignificant effect on $F\{d\}$, except salt may flow and encapsulate all materials
- ***Precipitation*** of dissolved materials/corrosion products - pervasive aggregation/cementation of all materials (in addition to particulates)
- ***Fragmentation*** due to tensile failure - insignificant effect on $F\{d\}$ (i.e., particles are not weak), except for possibly cellulose

W

Chemical Processes

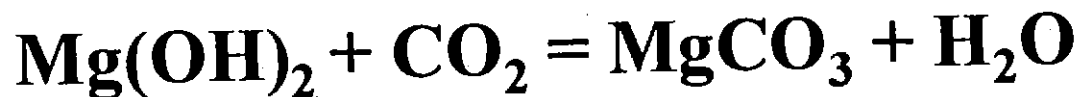
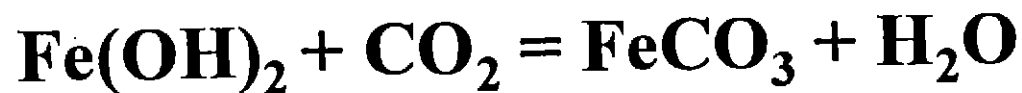
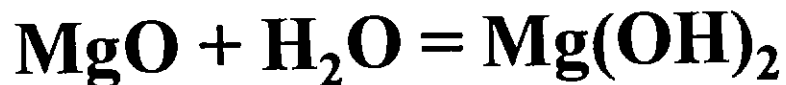
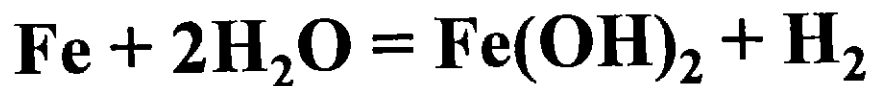
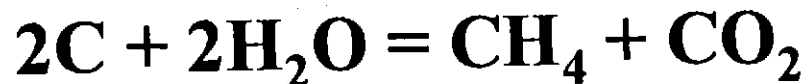

dissolution of MgO is probably faster than corrosion of Fe

biodegradation produces CO_2

H_2O contains dissolved NaCl, which precipitates





Predicted Extent of Processes

Process	Predicted Extent as Function of Time (see note 1)	Variability in Repository
crushing/compaction	from room/closure	(see note 2)
corrosion	from brine volume&dissolution	(see note 2)
bio-degradation	from brine volume	(see note 2)
dissolution	from brine volume & corrosion	(see note 2)
cementation	from corrosion, dissolution, precipitation	(see note 2)
fragmentation	during spalling/intrusion	(see note 2)

Note 1: Predicted extent of processes to be provided by performance assessment (e.g., BRAGFLO).

Note 2: Insignificant variability among rooms prior to intrusion. However, significant variability at barrel scale in all processes.

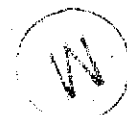

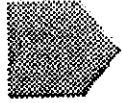

Effects of Processes on Materials

Material	corrosion	bio-degradation	dissolution	type
iron-base metal/alloys	✓			1
aluminum-base metal/alloys	✓			1
other metal/alloys				2
other inorganic materials				2
vitrified				2
cellulosics		✓✓		4
rubber		✓		5
plastics		✓		5
solidified inorganic materials				2
solidified organic material		✓✓		4
cement (solidified)				2
soils				2
steel packaging	✓			1
plastics packaging		✓		5
lead packaging				2
steel plug	✓			1
MgO backfill			✓	6
salt				3



Note: salt encapsulation and cementation will affect aggregation of all materials, and fragmentation might affect cellulosics

PR3 1930.301/63487.ppt



Material Groups - Initial Conditions and Processes

- 1. iron- and aluminum base** - shavings (1 mm) to steel plug (0.3m³), relatively independent on 1 drum/SWB laterally and vertically, dominated by variability (not ignorance); subject to corrosion
- 2. non-iron metals/inorganic/vitrified/soils/cements/solidified inorganics** - solid inorganic particulates (5micron) to vitrified drum size (0.21m³), independent on 7-pack/SWB scale laterally (and typically less) and 1 drum vertically, dominated by variability (not ignorance); crushing due to room closure of friable materials included in initial particle sizes
- 3. salt** - dust (1 micron) to half roomsize slab 2m thick (1000m³), independent on room scale but mostly at top of room, dominated by variability (not ignorance); crushing/plastic flow/compaction of roof fall particles included in initial particle sizes



Material Groups - Initial Conditions and Processes

4. *cellulosics/solidified organics* - solidified organic particles (0.2mm) to compressed HEPA filter (1.9m³), relatively independent on 1 drum laterally (except for solidified organics, which are 7-pack/SWB) and vertically, dominated by variability (not ignorance); subject to biodegradation and possibly fragmentation
5. *rubber/plastics* - drum filter gaskets (1cc) to 90 mil drum liner (0.03m³), relatively independent on 1 drum laterally and vertically, dominated by variability (not ignorance); subject to biodegradation
6. *MgO backfill* - 0.5-4mm diameter pellets, uniform size distribution (located mostly at the top and sides of room), scale independent; subject to dissolution

Note: All materials subject to cementation and salt encapsulation (especially at room boundary)

Initial Particle Size Population

- The types of materials and overall amounts in each group were identified (ref. BIR), and their average particle size and % of total amount were estimated based on judgment (consistent with Clements & Kudera, as discussed by EEG, and with video of drum sampling program)
- Cumulative frequency distributions of initial particle volume (m³) were then developed for each group, appropriate for large scale
- A continuous curve (i.e., piece-wise power law) was fit to the data, including the assessed minimum size
- This analytical CCDF is the best available unbiased estimate

Initial Particle Size Population - 1. Fe&Al-Base Metals

material	Size (m3)	Number	cdf	ccdf
waste	2.5E-07	4000000	0.028398	0.971602
waste	0.000001	1.50E+07	0.134892	0.865108
waste	0.00001	8.50E+07	0.738358	0.261642
waste	0.0001	3.50E+07	0.986844	0.013156
waste	0.001	1.10E+06	0.994653	0.005347
drum	0.0045	730000	0.999836	0.000164
SWB	0.05	4460	0.999868	0.000132
SWB OP	0.067	4460	0.999899	0.000101
canister	0.083	7100	0.99995	5.04E-05
plugs	0.358	7100	1	1.11E-16
	sum =	1.41E+08		
	total wt (k)	74423520		

M

Initial Particle Size Population - 1. Fe&Al-Base Metals

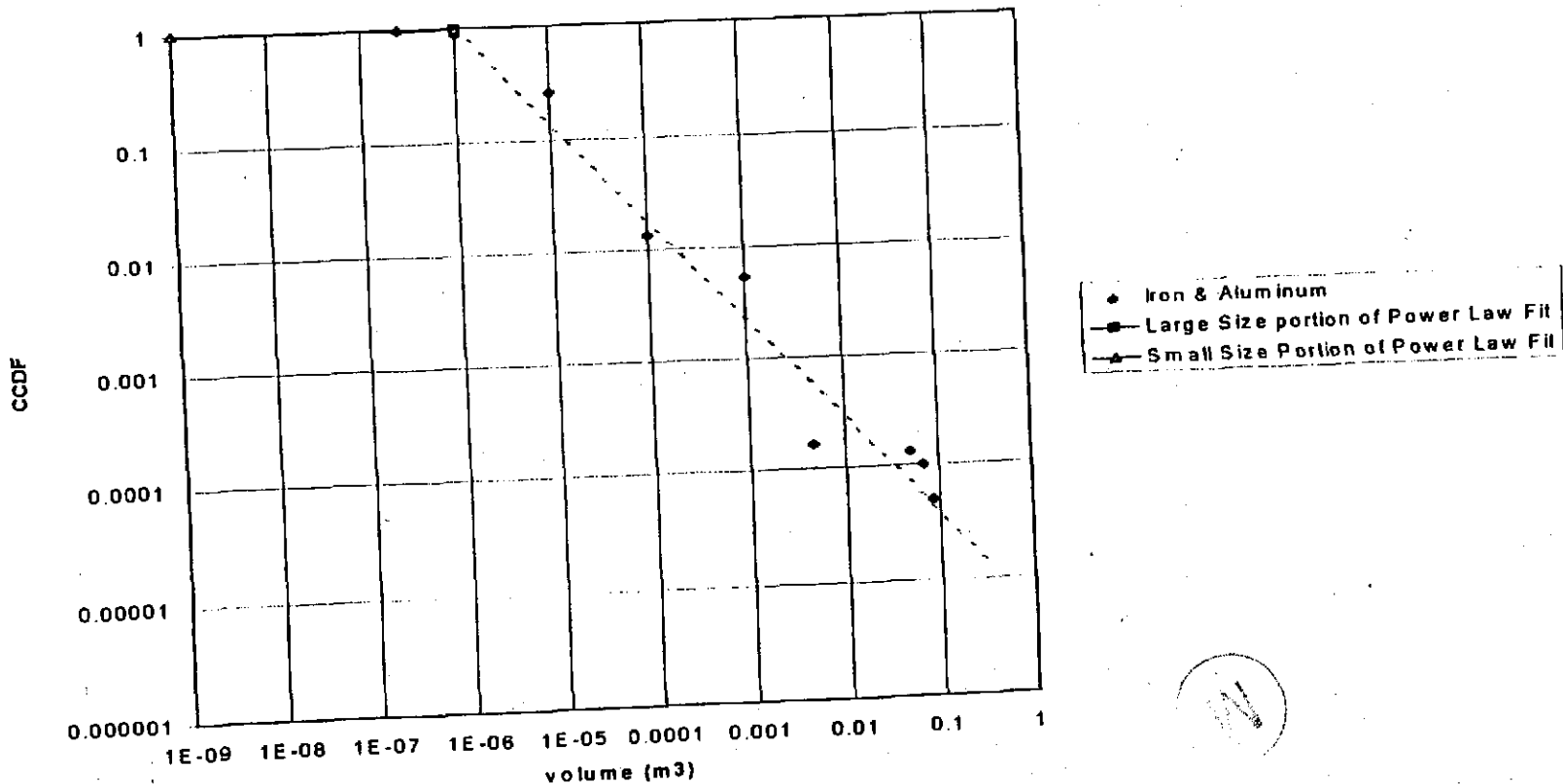

$$1-F\{v\} = \{1.0E-6/v(m^3)\}^{0.88} \text{ for } v > 10^{-6}$$

$$= \{1.0E-9/v(m^3)\}^{0.0043} \text{ for } v > 10^{-6}$$

PR3 1930.301/63487.ppt



Information Only

Initial Particle Size Population - 2. Other Metals/Soils/etc.

Material	Mass	Density	Size	units	Size (m3)	Number	cdf	ccdf
inorganic nonmetal - <10	1.00E+04	2.5	5 micron		1.25E-16	3.2E+16	0.868566	0.131434
Pb - particulate gloves	1.56E+06	11.3	1.00E+02 micron		1E-12	1.38E+14	0.872313	0.127687
inorganic nonmetal - <212	1.50E+05	2.5	100 micron		1E-12	6E+13	0.873941	0.126059
soils	7.42E+06	2.2	0.1 mm		1E-12	3.37E+15	0.965486	0.034514
solidified inorganics	9.25E+06	1.3	0.2 mm		8E-12	8.89E+14	0.989628	0.010372
cement	8.56E+06	2.8	0.2 mm		8E-12	3.82E+14	1	1.6E-09
inorganic nonmetal - interme	9.80E+05	2.5	2 cm		0.000008	49000000	1	2.74E-10
inorganic nonmetal - coarse	4.54E+06	2.5	213 cc		0.000213	8525822	1	4.27E-11
other alloys - crucible	2.60E+06	8	2.3 kg		0.000288	1130435	1	1.2E-11
Pb bricks	3.64E+06	11.3	0.001 m3		0.001	322123.9	1	3.27E-12
Pb 4'x2'	5.20E+06	11.3	0.005 m3		0.005	92035.4	1	7.75E-13
lead RH packaging	3.24E+06	11.3	0.037 m3		0.037	7749.342	1	5.65E-13
vitrified	9.30E+06	3	0.53 m		0.148877	20822.56	1	0

total 5.65E+07

3.68E+16

PR3 1930.301/63487.ppt



Initial Particle Size Population - 2. Other Metals/Soils/etc.

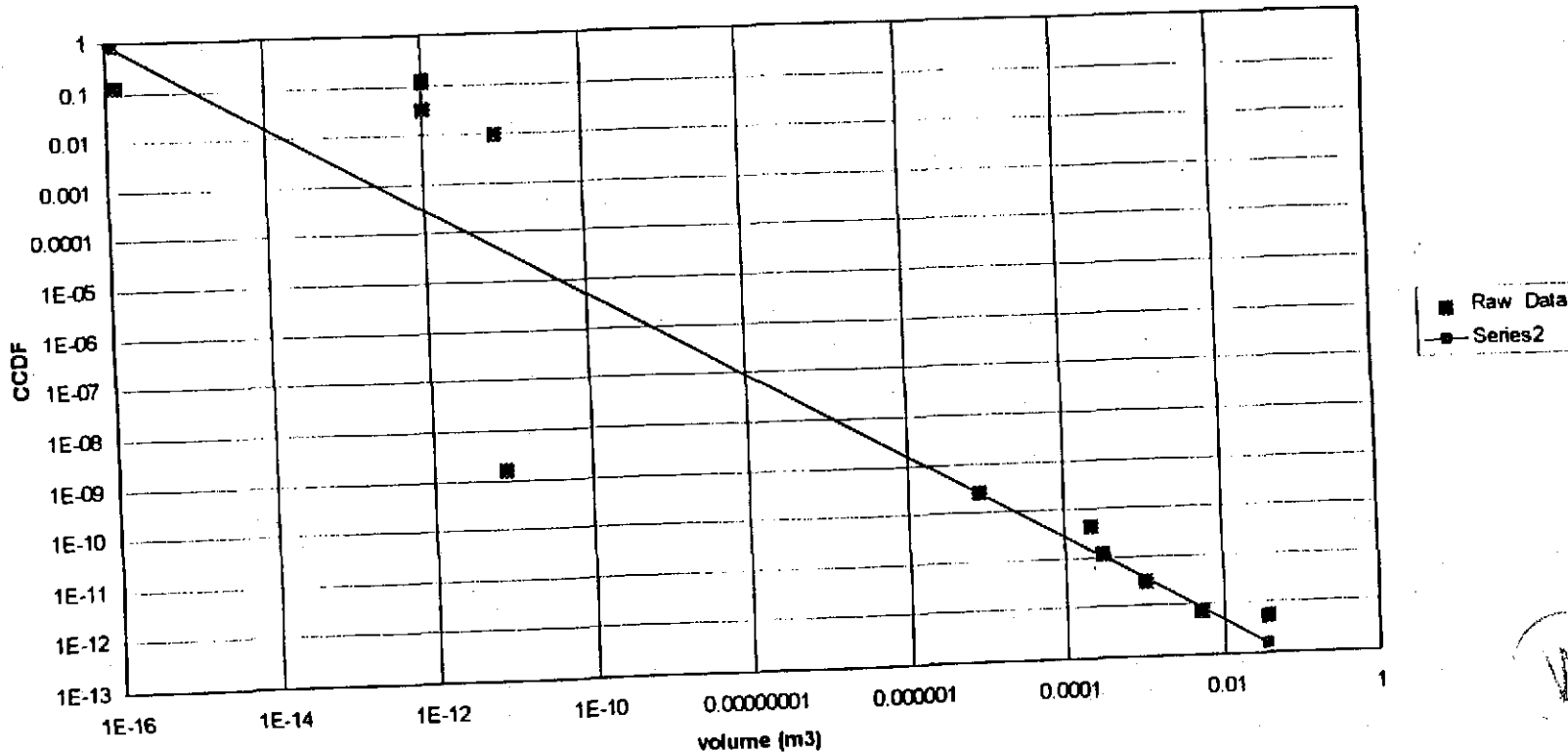

$$1 - F\{v\} = \{1E-16/v(m^3)\}^{0.88}$$



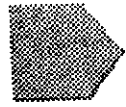

Initial Particle Size Population - 3. Salt

range of 10^{-18} m³ to 10^3 m³,
with mean of 10^{-5} m³



Initial Particle Size Population - 3. Salt

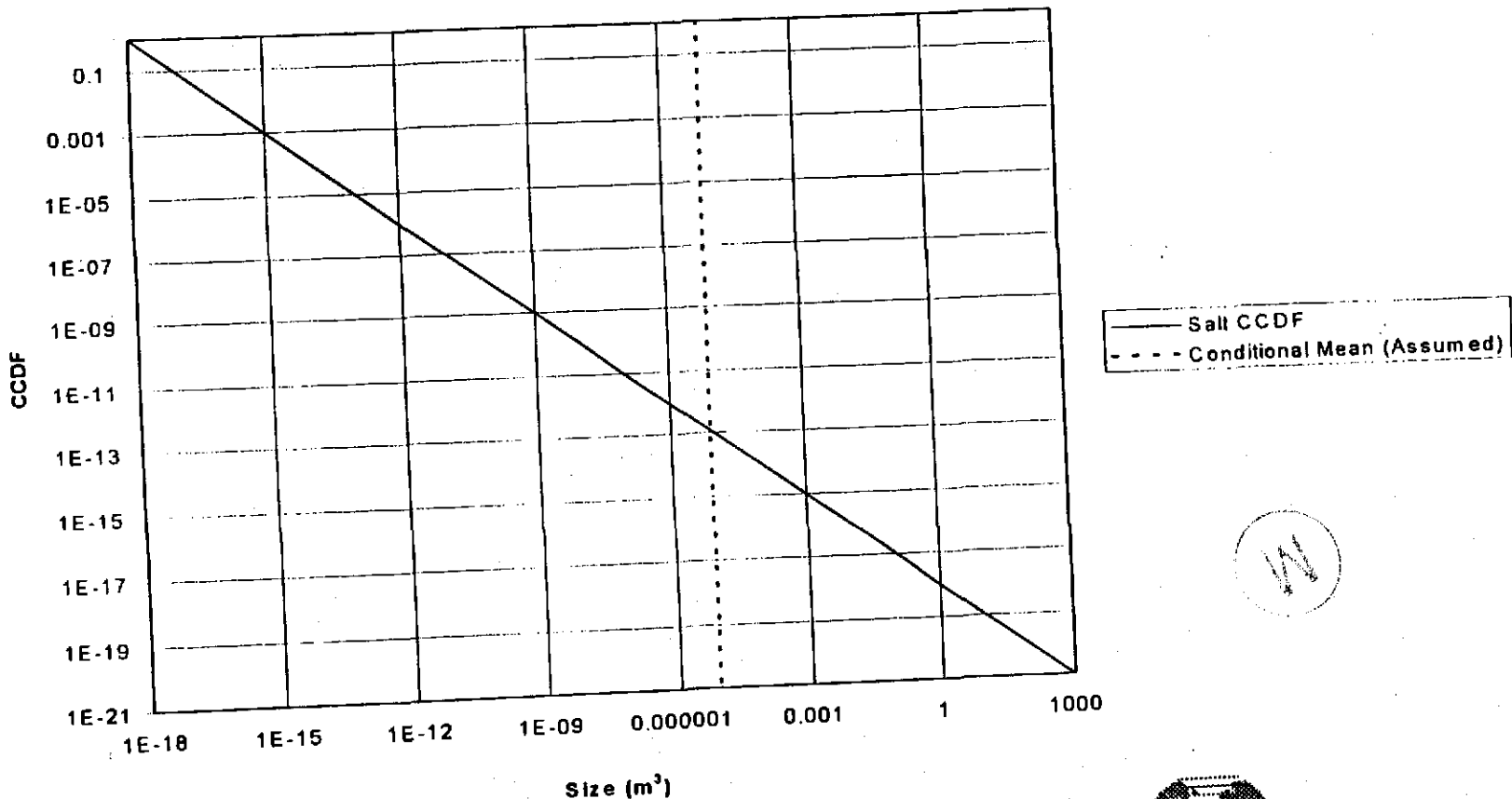

$$1 - F\{v\} = \{1E-18/v(m^3)\}^{1.00}$$

PR3 1930.301/63487.ppt





Initial Particle Size Population - 4. Cellulosics/Solidified Organics

Material	mass %	volume (m3)	density	eqv diameter (c	Size (m3)	Number	ccf	ccdf
solidified organics (1970-1986)		980	2.0	0.0	1.00E-11	9.80E+13	0.999995	5.3E-06
solidified organics (1986-)		172	2.0	1.0	0.000001	1.72E+08	0.999996	3.55E-06
Kimwipes	5%	512	0.9	1.3	0.000002	2.56E+08	0.999999	9.35E-07
sm paper filters	10%	1024	0.9	3.0	0.000027	3.79E+07	0.999999	5.48E-07
20mil 12'x12' rags	15%	1537	0.9	3.6	4.70E-05	3.27E+07	1	2.14E-07
10mil 10'x12' cardboard cartons	10%	1024	0.9	4.5	9.10E-05	1.13E+07	1	9.94E-08
HEPA filters	15%	1537	0.9	6.6	2.90E-04	5.30E+06	1	4.53E-08
wood frames for filters	10%	1024	0.9	7.3	3.90E-04	2.63E+06	1	1.85E-08
1.5m2 coveralls/bodies	10%	1024	0.9	9.1	7.50E-04	1.37E+06	1	4.58E-09
HEPA filters	15%	1537	0.9	16.5	4.50E-03	3.41E+05	1	1.09E-09
wood frames for filters	5%	512	0.9	18.5	6.30E-03	8.13E+04	1	2.61E-10
2x4x3/4" plywood	5%	512	0.9	27.0	0.02	25611.11	1	0
	100%							
total weight (kg)		9.22E+06	10244.4444		sum=	9.8E+13		



PR3 1930.301/63487.ppt





Initial Particle Size Population - 4. Cellulosics/Solidified Organics

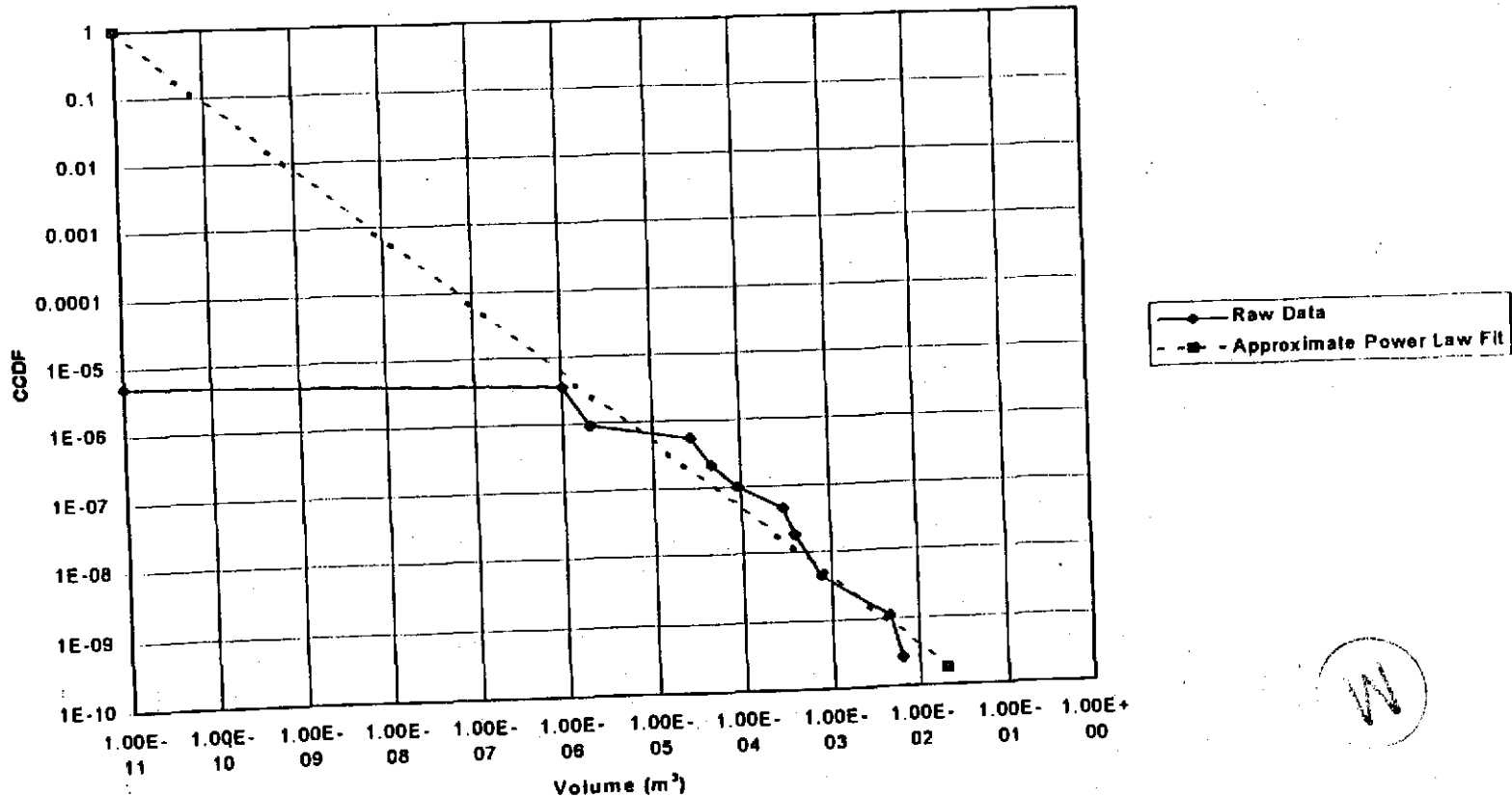

$1 - F\{v\} = \{1E-11/v(m^3)\}^{1.05}$
could use separate description for e-11 to e-6

PR3 1930.301/63487.ppt



Information Only

Initial Particle Size Population - 5. Plastics/Rubbers

Material	Size (m3)	Number	Density	Weight (kg)	cdf	ccdf
HEPA Filter rings	0.000001	1000000	1.14	1140	0.022071	0.977929
smaller pieces	0.00001	14600000	1	146000	0.344303	0.655697
gloves	0.0001	4.00E+06	1.14	456000	0.432586	0.567414
small bags	0.0001	2.19E+07	1	2190000	0.915934	0.084066
drum gaskets	0.00015	7.30E+05	0.5	54750	0.932046	0.067954
SWB gasket	0.00045	8920	0.5	2007	0.932243	0.067757
Pb gloves	0.001	1.00E+06	1.14	1140000	0.954314	0.045686
large bags	0.001	1.46E+06	1	1460000	0.986537	0.013463
apron	0.004	10000	1.14	45600	0.986758	0.013242
90mil HDPE liner	0.0077	600000	1	4620000	1	0
				10115497		

PR3 1930.301/63487.ppt



Information Only

Initial Particle Size Population - 5. Plastics/Rubbers

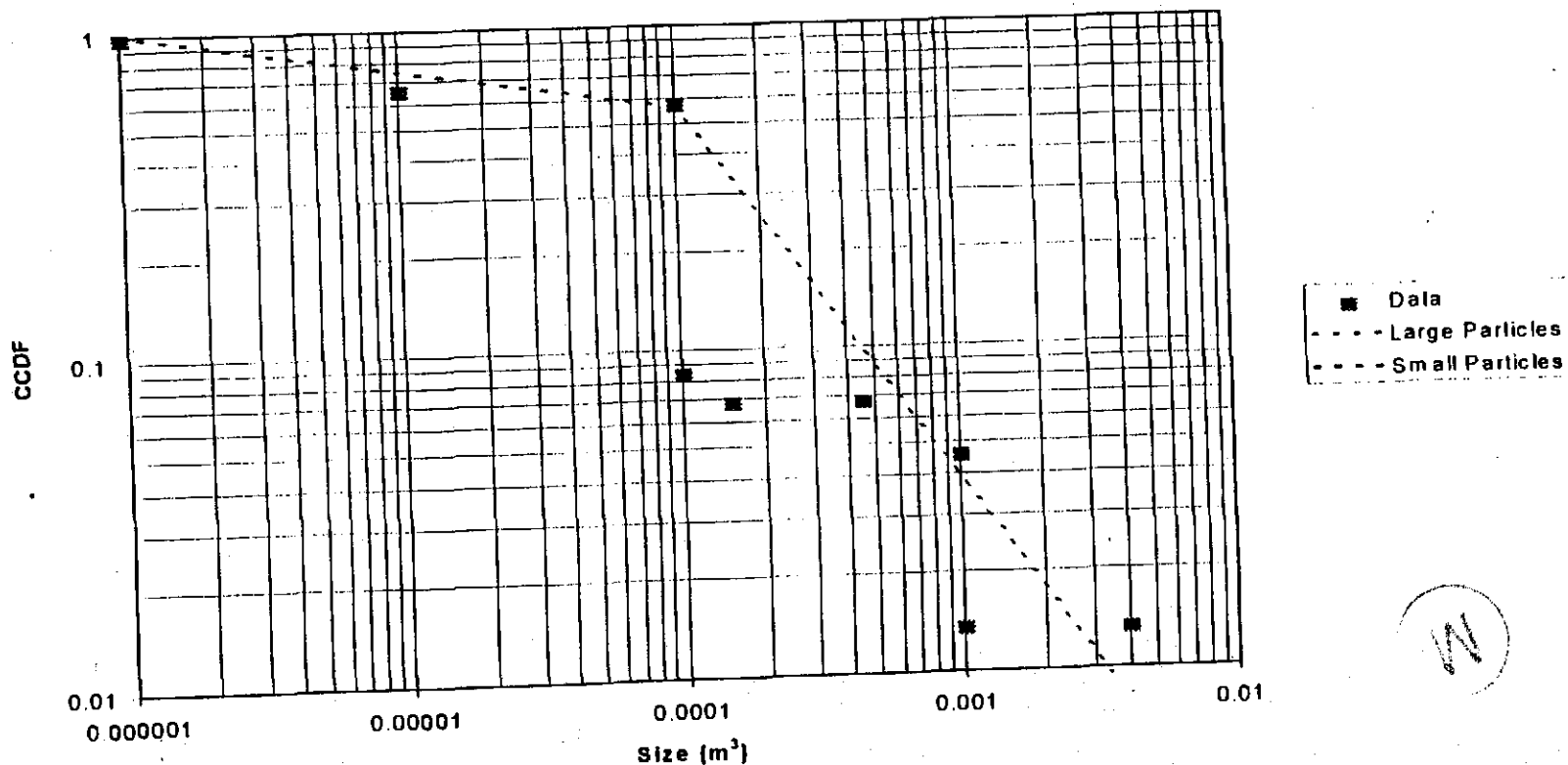

$$1 - F\{v\} = \{6E-5/v(m^3)\}^{1.15} \text{ for } v > 10^{-4}$$

$$= \{1E-6/v(m^3)\}^{0.124} \text{ for } v < 10^{-4}$$



Initial Particle Size Population - 6. MgO Backfill

constant $f\{v\} = 10E-9$ (m³)





Modeled Degradation Processes (1 of 2)

■ *Corrosion*

1. Fe and Al base metals

■ *Biodegradation*

4. Cellulosics and Solidified Organics
5. Rubber and Plastics

■ *Dissolution*

6. MgO Backfill



Modeled Degradation Processes (2 of 2)

- ***Cementation***
all materials
- ***Encapsulation***
all materials
- ***Fragmentation***
possibly cellulose

Note: extent of a process is a function of time and is uncertain for any location (due to ignorance and variability among locations), possibly correlated with each other and among locations depending on scale

Corrosion

- PA will predict extent of corrosion (% of material remaining) as function of time, based on brine inflow and competition with MgO dissolution
- It is assumed that:
 - uniform corrosion occurs, i.e., Δr is same for all particles
 - portion of the corroded materials precipitate out as small particles (0.1-10 microns, avg 2), depending on available pore space
- Change in particle size distribution is fully determined by extent of corrosion and byproducts

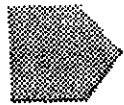

Precipitation

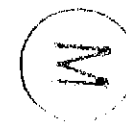
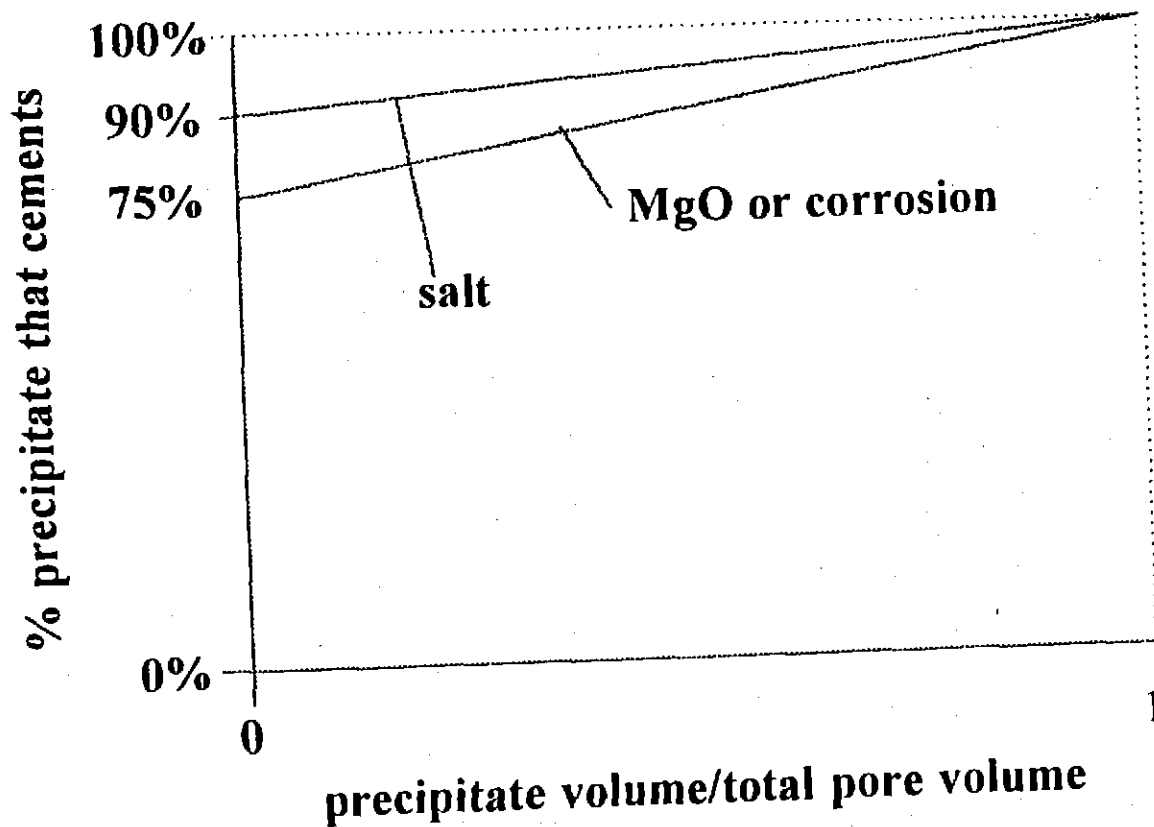

Note: precipitates either form particulates or cement

Biodegradation

- PA will predict extent of biodegradation (% of material remaining) as function of time, based on the amount of brine in the room
- It is assumed that
 - uniform biodegradation occurs, i.e., Δr is same for all particles
 - there are no particulate byproducts
- Change in particle size distribution is fully determined by extent of biodegradation

W



Dissolution

- PA will predict extent of MgO dissolution (% of material remaining) as function of time, based on brine inflow and competition with corrosion
- It is assumed that:
 - uniform dissolution occurs, i.e., Δr is same for all particles
 - portion of the dissolved materials precipitate out as small particles (0.1-10 microns, avg 2), depending on available pore space
- Change in particle size distribution is fully determined by extent of dissolution and byproducts

PR3 1930.301/63487.ppt



Cementation

■ It is assumed that

- corrosion materials, dissolved MgO and salt from brine that do not precipitate out as particulates will cement other particles together (regardless of type)
- smaller particles are more likely to aggregate, with the likelihood being inversely proportional to volume

■ Change in particle size distribution is fully determined by amount of corrosion, MgO dissolution, and salt precipitation, and portion of non-particulate byproducts





Cementation

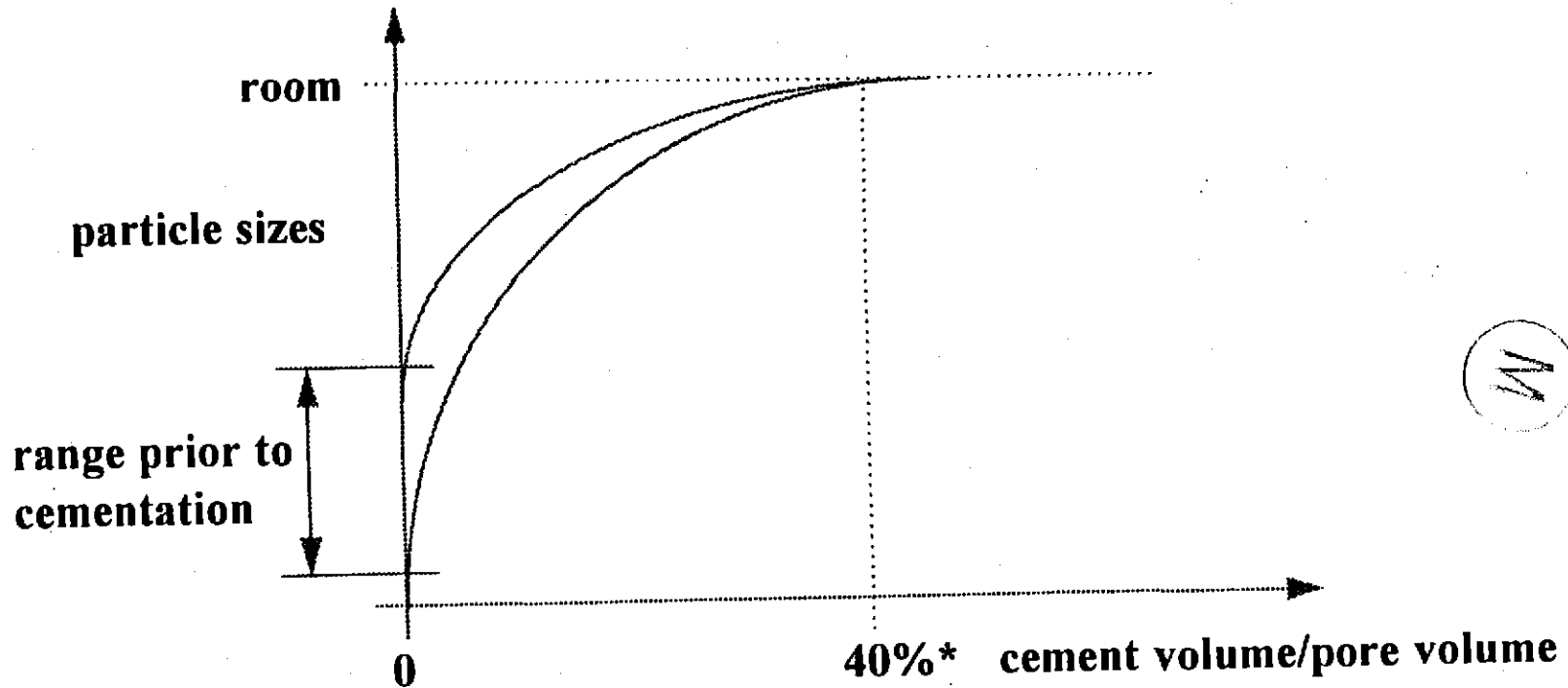

Note: example for precementation porosity of 25%

PR3 1930.301/63487.ppt



Encapsulation

- PA will predict room closure as function of time, considering stiffness of waste (as well as gas pressure, etc.)
- It is assumed that
 - salt intrusion front = room closure without waste
 - all particle sizes are equally likely to be encapsulated
 - encapsulation produces a large ($>10\text{m}^3$) particle
- Change in particle size distribution is fully determined by total volume encapsulated



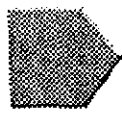

Decomposition Model Schematic

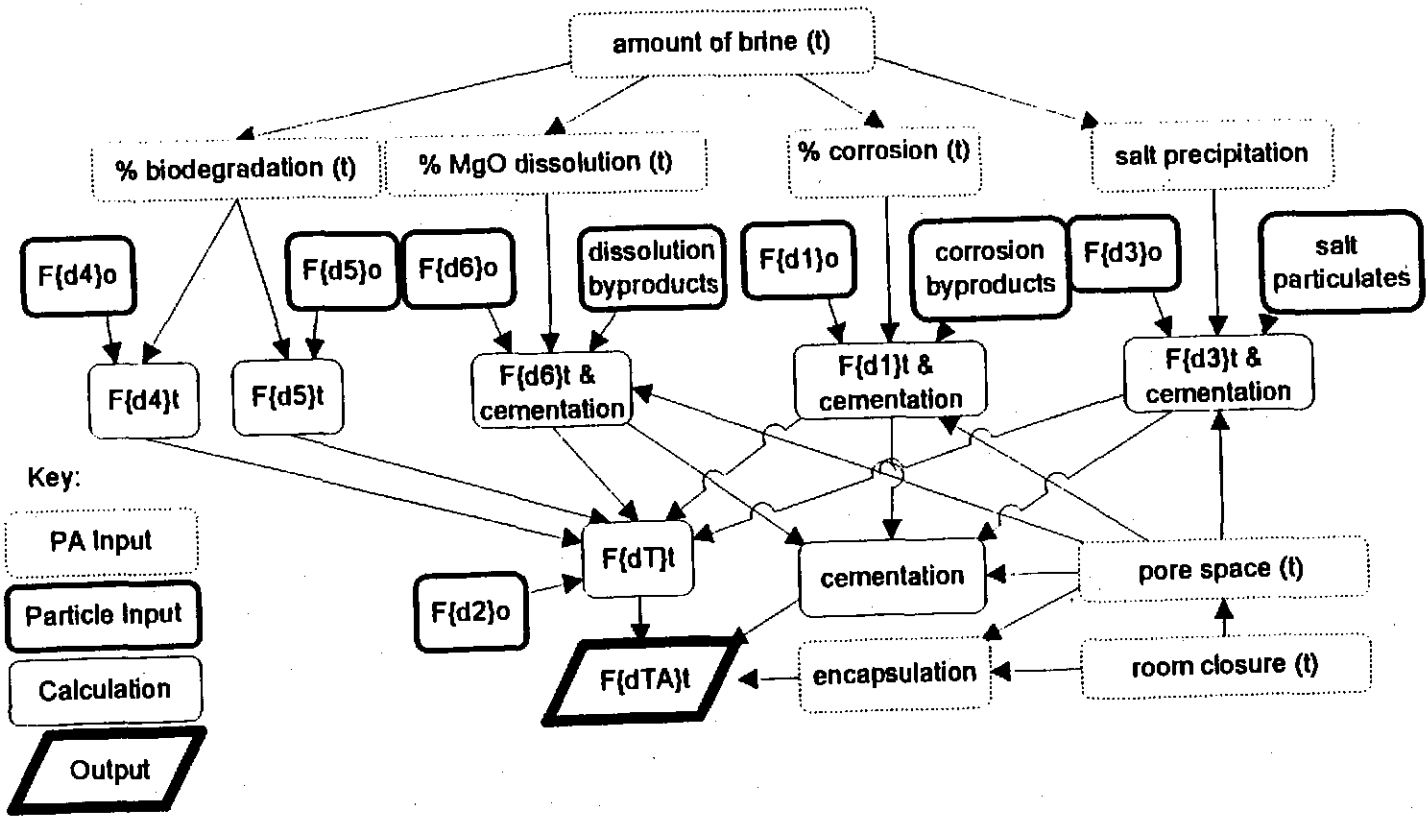



Prediction of Particle Size - One Material and One Process

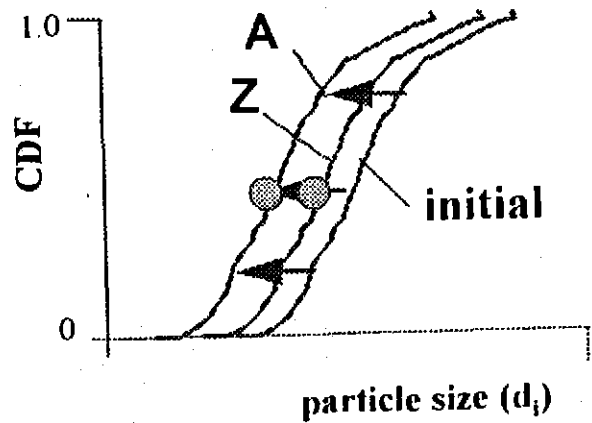
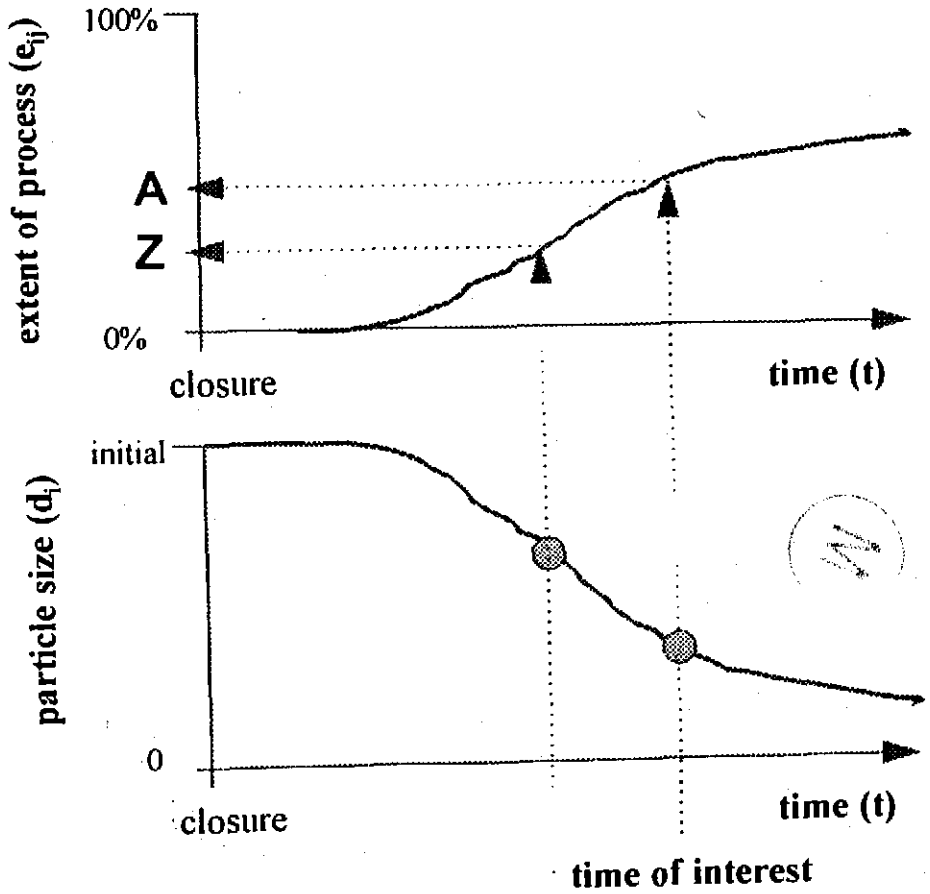

Note: particle size is in terms of any percentile value

PR3 1930.301/63487.ppt



Information Only

Prediction of Particle Size - One Material and Multiple Processes

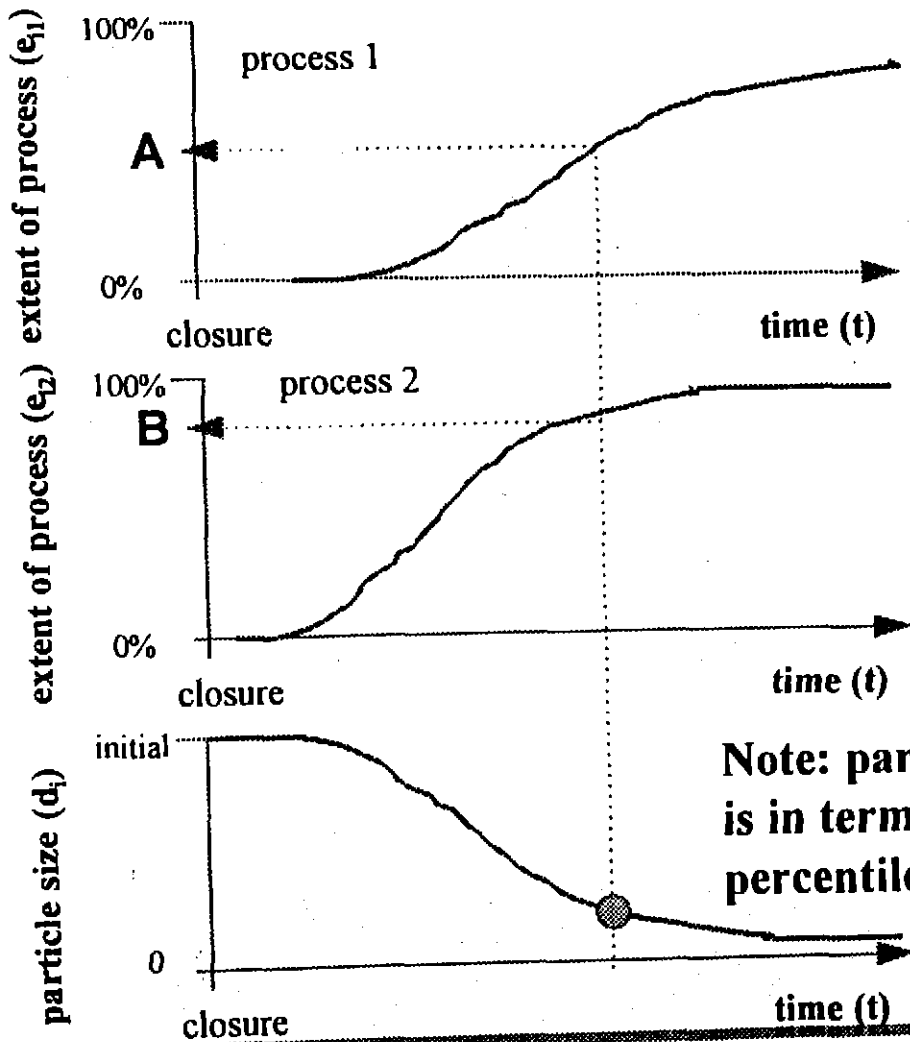

Note: particle size is in terms of any percentile value

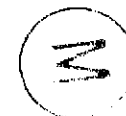
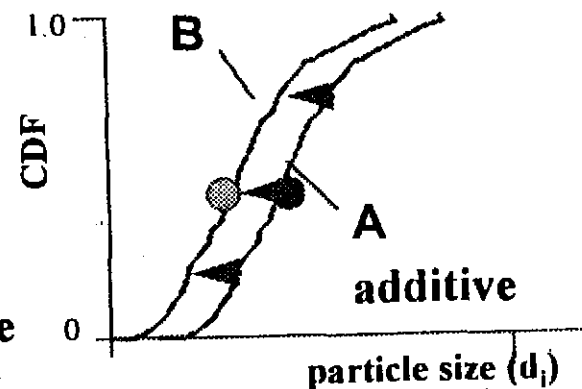
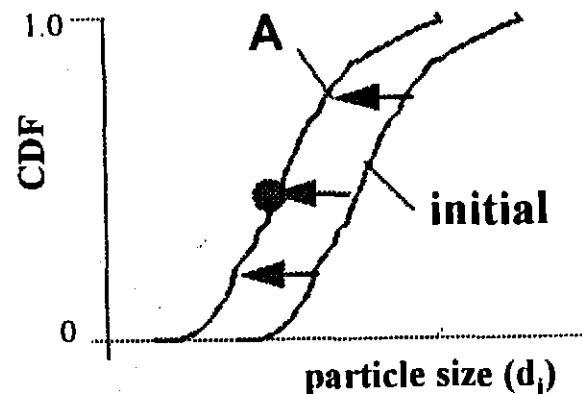



Prediction of Particle Size - Multiple Material and Processes

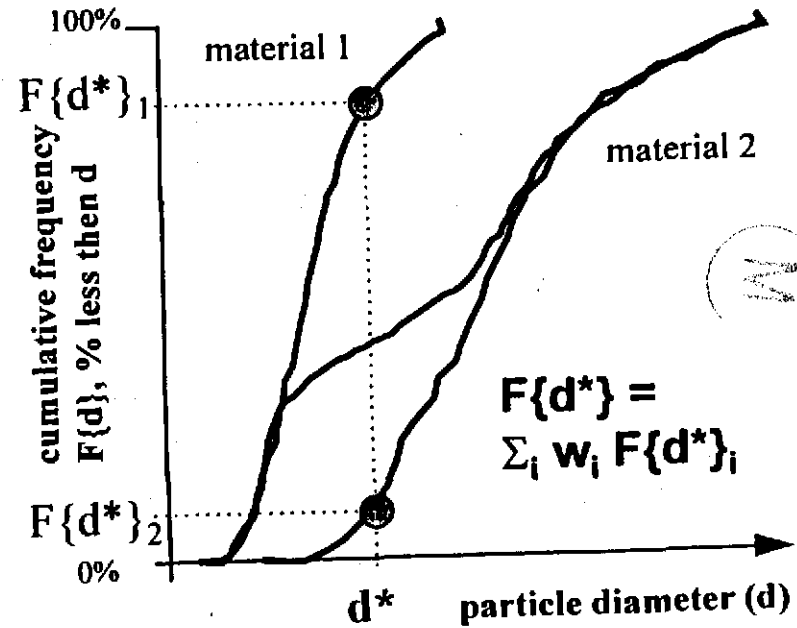
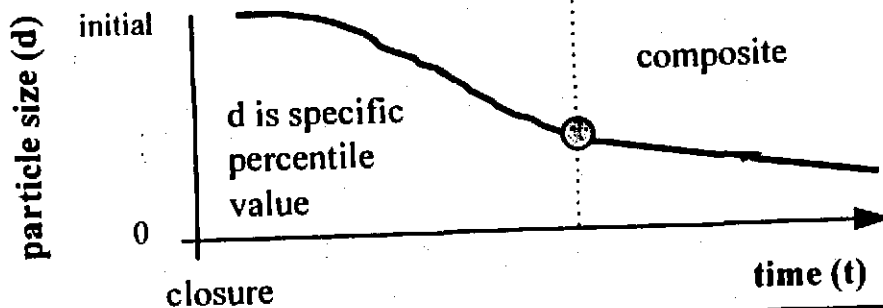
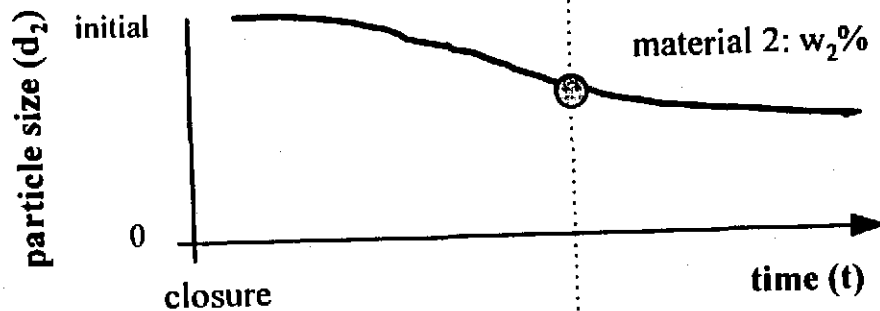
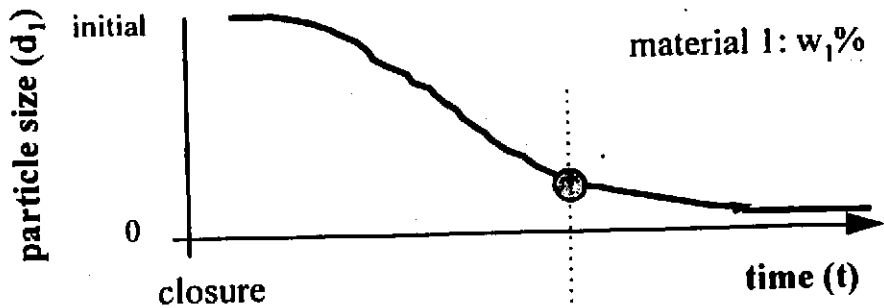

Note: particle size is in terms of any percentile value

LEIF G. ERIKSSON, P.G.
3080 Pillement Place, Alpharetta, Georgia 30202, USA
(770) 642-6222

QUALIFICATIONS SUMMARY

- Advanced degrees in Civil Engineering and Geology augmented by post-graduate courses;
- Registered Professional Geologist in North Carolina (1987 - present);
- 36+ years of international professional experience in earth-sciences and project management;
- 30+ years of international experience in marketing and managing a broad range of multi-disciplinary, state-of-the-art projects, including 19+ years of international experience in safe hazardous and radioactive waste management with emphasis on deep geological disposal;
- International experiences as expert earth-sciences and geoengineering witness;
- 18+ years of professional experience in the USA, including successful marketing, management, and expert technical management and support of large, multi-disciplinary, state-of-the-art national programs; and
- Author/co-author of 20+ professional papers with emphasis on site characterization and the environmentally safe utilization of underground space.

EDUCATION

- 1975 M.A. & Sc., Geology, The Stockholm University, Sweden (obtained concurrent with full-time work)
- 1960 B.Sc., Civil Engineering, Stockholm Technical High School, Sweden

Postgraduate Courses:

- 1996 *The Resource Conservation and Recovery Act*, McCoy and Associates, Inc.
- 1990 *Code of Federal Regulations, Title 29, Part 1910.120(e) Hazardous Waste Site Investigations and Site Supervisor's Health and Safety Training*, Golder Associates Inc.
- 1988 *Contracts*, The Engineers Joint Contract Documents Committee (EJCDC)
- 1973 *Soil Mechanics*, The Royal Institute of Technology, Stockholm, Sweden
- 1970 *Advanced Concrete Technology*, The Swedish Cement and Concrete Institute at the Royal Institute of Technology, Stockholm, Sweden

ANNOTATED EMPLOYMENT HISTORY AND MAIN RESPONSIBILITIES

1993 - **Advanced Sciences, Inc., (ASI) Carlsbad, New Mexico, USA.**

Deputy Project Manager and Manager of Regulatory Compliance, Research, and International Programs for the Technical Assistance Contractor (CTAC) to the U.S. Department of Energy (USDOE) Carlsbad Area Office (CAO). Serves as the CAO's focal point for international outreach. ASI is the prime CTAC contractor supporting the CAO's successful implementation of the National TRU Program (NTP) and the opening and safe operation of the Waste Isolation Pilot Plant (WIPP) in compliance with applicable laws, federal and state regulations, and DOE Orders. The NTP involves the planning and implementation of practices and safeguards for the characterization, treatment, storage, and preparation for shipment of transuranic radioactive waste (TRUW) stored or to be generated through 2033 at ten large- and 15 small-quantity TRUW generator/storage sites in

LEIF G. ERIKSSON, P.G.
3080 Pillement Place, Alpharetta, Georgia 30202, USA
(770) 642-6222

the USA. The WIPP is a first-of-a-kind deep geological disposal system (repository) for TRUW and TRUW mixed with regulated hazardous waste. Provided on-site program management and technical supervision involving 90+ CTAC employees and annual budgets of up to 18 million dollars during the detailed site characterization, preliminary design, construction and maintenance, safety and performance assessments, and preparation of required hazardous and radioactive waste receipt, storage, and disposal permits (the 1995 No-Migration Variance Petition and RCRA Part B Permit, and the 1996 Compliance Certification Application) for the WIPP.

1991 - 1993 AB Ingenjorsgeologi (ABI) Inc., Alpharetta, Georgia, USA.

President of family-owned small-business corporation. Served as either independent consultant or temporary employee on the following select assignments/contracts:

- 1993 *Consultant* to **Advanced Sciences Inc. (ASI)**, Albuquerque, New Mexico, on USDOE's WIPP project supporting experimental and mixed-TRUW integration activities, and interactions with regulators, oversight organizations, and stakeholders.
- 1992 - 93 *Consultant* to the **Argonne National Laboratory**, Chicago, Illinois, on USDOE's Office of Environmental Restoration and Waste Management program providing technical and administrative assistance on: program planning and analysis; cost and schedule estimating and control; facility and systems engineering and safety; conduct of operations; and environmental protection and compliance assessment.
- 1992 - 93 *Consultant* to the **International Atomic Energy Agency (IAEA)**, Vienna, Austria, reviewing six top-level IAEA series No. 111 Radioactive Waste Safety Series Standards (RADWASS) documents - A Series of International Consensus Documents on the Safe Management and Disposal of Radioactive Waste.
- 1992 *Nuclear Engineer Level P-5* with the **Division of Nuclear Fuel Cycle and Waste Management - Waste Management Section of the IAEA**, Vienna, Austria. Designated IAEA point of contact with the government of Ukraine for the International Competition on the Long-Term Isolation and Environmental Restoration of Unit 4 at the Chernobyl Nuclear Power Plant. Advised the Organizing Committee for the International Competition on: the streamlining of the proposal process; the development of a clear, concise, request for proposal; the adequacy and relevance of available scientific and engineering data; the preparation of scientific and technical support documents for the solicitation process; the identification and coordination of international experts for the evaluation panel; the identification of candidate international competitors (bidders); and activities promoting the solicitation process.
- 1991 - 92 *Senior Staff Officer* with the **National Academy of Sciences' (NAS) Board on Radioactive Waste Management (BRWM)**, Washington, District of Columbia, USA. Planned, organized, and integrated study panels, and initially managed the three-year, 1.8 million dollar Separations Technology and Transmutation Systems (STATS) study sponsored by the USDOE, including the January 1992 International STATS Symposium attended by 200 invited domestic and international STATS experts and decision makers.

LEIF G. ERIKSSON, P.G.
3080 Pillement Place, Alpharetta, Georgia 30202, USA
(770) 642-6222

1987 - 1991 Golder Associates Inc., Richland, Washington (then Atlanta, Georgia), USA.

1988 - 91 *Associate and Manager of Special Projects and Principal Radioactive Waste Management Geoscientist and Geoengineer in the Atlanta Office.* Developed, planned, and managed a broad range of multi-disciplinary environmental projects with emphasis on site characterization, design, construction, and remediation of radioactive and hazardous waste facilities in compliance with applicable laws and regulations.

1990 *Principal Investigator* for an Independent Site Suitability Assessment of the Yucca Mountain candidate spent nuclear fuel and other high-level radioactive waste (HLW) repository site based on fully integrated stochastic models in support of the USDOE's Office of Civilian Radioactive Waste Management (OCRWM) Program. Identified and reviewed applicable laws, regulations, and USDOE documents, and developed draft site-suitability determination criteria.

1987 - 88 *Manager of Golder Associates Inc.'s Richland Branch Office and Deputy Project Manager and Task Manager* for the four-year, 18.2 million dollar, Basalt Waste Isolation Project (BWIP) Geotechnical Support Services contract in support of the development of a deep geological repository for safe disposal of HLW in the basalts at the Hanford Reservation, Washington for Westinghouse Hanford Company. Administered and coordinated three large subcontractors and more than 60 tasks. Managed and technically supervised 1 tasks and 20+ staff, including the development of five years integrated logic networks for 7,000+ BWIP activities, and the review and revision of 400+ quality assurance and Project Management procedures.

1986 - 1987 Shannon & Wilson, Inc., Seattle, Washington, USA.

Senior Associate and Manager of Nuclear Waste Services and Leader of the Railroad Services Group. Marketed, managed, and technically supported the firm's radioactive waste management projects, including co-authoring Chapter 2.3 of the Site Characterization Plan for the Deaf Smith County candidate HLW repository site (rock salt), and reviewed five outyears budget for in situ characterization of an Exploratory Shaft Facility in salt for Golder Associates Inc.

1981 - 1986 The Earth Technology Corporation, Long Beach, California, USA.

Senior Geological Engineer, then Managing Senior Geological Engineer, Manager of the Geomechanics Discipline and Leader of the Advanced Underground Technology Group. Project Manager, Lead Geological Engineer, and/or Principal Reviewer for environmental impact assessments, site characterizations, and state-of-the-art technology and methodology applications in support of: nuclear power plant siting (Republic of China); the development of safe deep geological radioactive waste disposal systems for HLW in the contiguous USA (the OCRWM and the NWTs programs) and in Sweden (the KBS and the SKB programs); national and regional screenings for a Superconducting Super Collider (SSC) facility in the contiguous USA; national, regional, and area screenings for a Deep-Based Intercontinental Ballistic Missile facility in the contiguous USA; and various energy storage projects/programs (e.g., compressed air [CAES], pumped hydro, and hydrocarbons (e.g., the Strategic Petroleum Reserve [SPR] program)) in the USA.

LEIF G. ERIKSSON, P.G.
3080 Pillement Place, Alpharetta, Georgia 30202, USA
(770) 642-6222



1978 - 1981 AB Ingenjorsgeologi, Stockholm, Sweden. (See also 1991 above.)

Provided senior geosciences and geoengineering expertise and project management services under long-term exclusive services contracts. Select positions and main responsibilities include:

- 1980 - 81 *Acting Staff Scientist III* at **Lawrence Berkeley Laboratory (LBL)**, University of California, Berkeley, California, USA. Developed siting guidelines and conceptual design for a deep underground HLW repository test facility in basalt, and inventoried, inspected, and assessed select underground facilities in crystalline rock for potential use as a repository test facility for the U.S. Nuclear Regulatory Commission.
- 1979 - 80 *Consultant* to **Rockwell Hanford Operations (RHO)**, Richland, Washington, USA. Acting Senior Resident RHO Engineer on the BWIP during the construction, operation, and testing of the Near-Surface Test Facility (NSTF). The NSTF was developed to qualify basalt as a potential host rock for a geologic HLW repository.
- 1978 - 79 *Senior Engineer and Member of the Advanced Technology Group* of **Dames & Moore (D&M)** London, United Kingdom (1978) and then Washington, District of Columbia, USA (1978-1979). Project Manager for the evaluation of room stability and gas outburst potential in a large operating domal salt mine in the southeastern USA to be partially converted to an SPR facility.

1965 - 1978 Hagconsult AB, Stockholm, Sweden and London, United Kingdom.

Engineer then Project Manager, responsible for R&D, marketing, project management, and expert witness testimony in support of a broad range of civic and environmental projects. Project Manager and Principal Investigator for site investigations, conceptual designs, and development of underground systems for environmental protection, energy storage, defense, communication, and transportation in Africa, Asia, and Europe. Lead Geological Engineer for R&D in support of enhanced site characterization techniques and equipments, tie-back anchor systems, grouting, ground freezing, and shotcrete applications. *Manager, London Branch Office, United Kingdom* (1974-1976). Marketed and managed middle- and south-European and north-African projects.

1963 - 1965 The Essinge Bridges Consortium, Stockholm, Sweden.

Surveyor, then Foreman. Conducted surveys and supervised staff (engineers and specialty workers) during the construction of free-suspending, prestressed bridges and connecting viaducts.

1960 - 1963 The Stockholm City Municipal Services Department, Stockholm, Sweden.

Assistant Supervisor, then Surveyor. Conducted surveys and supervised staff (specialty workers) during the reconstruction of the central core of the City of Stockholm, including the excavation and construction of Sergels Torg and the adjacent temporary Parliament building.

LEIF G. ERIKSSON, P.G.
3080 Pillement Place, Alpharetta, Georgia 30202, USA
(770) 642-6222

SELECT EXTRACURRICULAR PROFESSIONAL ACCOMPLISHMENTS

- *Registered Professional Geologist in the State of North Carolina, 1986 - present (Registration number 437).*
- *Member, Commission No. 14 of the International Association of Engineering Geology (IAEG) (1985 - Present). Responsible for the monitoring of and reporting on problems and issues of the United States of America's programs for safe disposal of long-lived radioactive wastes, i.e., TRUW and HLW, in deep geologic repositories. Four reports submitted to date (1986, 1988, 1990, and 1996).*
- *Member, Miscellaneous Program Advisory Committees: e.g., Waste Management Symposia Inc.'s WM'92, WM'96, and WM'97 Conferences held in Tucson, Arizona, USA; American Nuclear Society's Spectrum '96 Conference held in Seattle, Washington, USA; and American Society of Civil Engineers' and American Nuclear Society's Third, Sixth and Seventh International Conferences on High Level Radioactive Waste Management held in Las Vegas, Nevada, USA (1992, 1995, and 1996, respectively).*
- *Substitute Member, Core Group on Site Evaluation and Design of Experiments (SEDE) for Radioactive Waste Repositories, Organisation for Economic Co-operation and Development/ Nuclear Energy Agency (OECD/NEA), Paris, France (1990-1991).*
- *Member, Steering Committee for the National Academy of Sciences' "Colloquium on Quality Assurance (QA) Aspects of Geotechnical Practices for Underground Radioactive Waste Repositories," Washington, District of Columbia, USA (1988).*
- *Member, Deep Underground Space Committee of the Underground Technology Research Council, USA (1978-1982).*
- *Member, Geological Society (Geologiska Foreningen), Stockholm, Sweden (1972-1980).*

Additional information and references available upon request.



LEIF G. ERIKSSON, P.G.
3080 Pillement Place, Alpharetta, Georgia 30202, USA
(770) 642-6222

M

PUBLICATIONS

- Eriksson, L.G., 1996. "Report on the Safe Management and Disposal of Long-lived Radioactive Waste in the United States of America," prepared for Commission No. 14 of the International Association of Engineering Geology (IAEG), October 31, 1996 (Fourth Report).
- Dials, G.E., and Eriksson, L.G., 1996. "On the Verge of Opening A Deep Geological Repository for Disposal of Long-lived Radioactive Waste at the Waste Isolation Pilot Plant," Proceedings Spectrum '96 International Topical Meeting on Nuclear and Hazardous Waste Management, Seattle, Washington, August 18-23, 1996, 1:501-508.
- Eriksson, L.G., and Dials, G.E., 1996. "Safe Management and Disposal of Long-lived, Defense-generated Radioactive Waste in the United States of America," exhibited in Poster Session 3 and presented in Plenary Session 3 at the European Nuclear Society "TOPSEAL '96" meeting, Stockholm, Sweden, June 9-12, 1996.
- McFadden, M.H., and Eriksson, L.G., 1996. "Keys to Opening the Nation's First Deep Geological Repository in 1998," Proceedings of the Seventh Annual International Conference on High Level Radioactive Waste Management, Las Vegas, Nevada, April 29-May 3, 1996, 220-223.
- Dials, G.E., and Eriksson, L.G., 1995. "The Waste Isolation Pilot Plant-A Domestic Success with Global Implications," presented at the International Atomic Energy's Seminar on the Requirements for Safe Management of Radioactive Waste held in Vienna, Austria, August 28-31, 1995.
- Dials, G.E., and Eriksson, L.G., 1995. "Transuranic Radioactive (TRU) Waste Management in the USA," Proceedings Fifth International Conference on Radioactive Waste Management and Environmental Remediation, Berlin, Germany, September 3-8, 1995.
- Eriksson, L.G., 1991. "Comments on the Technical Basis for the EPA HLW Disposal Criteria Proposed in Working Draft No. 3 of 40CFR191," Proceedings of the EPRI Workshop 1-Technical Basis for EPA HLW Disposal Criteria, Crystal City, Virginia, USA, September 24-26, 1991, EPRI TR-100347, 401-413. (Invited comments.)
- Eriksson, L.G., 1991. "Key Engineered Barrier System Concepts and Components of The Minimum Disturbance to the Geologic Setting (MD) Design and Their Current Application to The Office of Civilian Radioactive Waste Management Program," Invited Technical Submittal to the USDOE's Engineered Barrier System Concepts Workshop, Denver, Colorado, June 1991.
- Eriksson, L.G., 1991. "The MD Design - A Cool Concept for Geologic Disposal of Radioactive Waste," Proceedings of the Second Annual International Conference on High Level Radioactive Waste Management, Las Vegas, Nevada, April-May 1991, 2:1569-1584.
- Eriksson, L.G., 1990. "1990 Biannual Report on the Office of Civilian Radioactive Waste Management (OCRWM) Program of the United States of America," prepared for Commission No. 14 of the IAEG (Third Report).
- Eriksson, L.G., and Pentz, D.L., 1990. "Natural System Issues in the OCRWM Program." Proceedings of the First International High-Level Radioactive Waste Management Conference and Exposition, Las Vegas, Nevada, April 1990, 1:10-19. (Invited Plenary Session paper.)

LEIF G. ERIKSSON, P.G.
3080 Pillement Place, Alpharetta, Georgia 30202, USA
(770) 642-6222

- Eriksson, L.G., 1990. "Is It Time to Reduce the Heat on the Concept of Geologic Disposal of High-Level Radioactive Waste?" *American Underground-Space Association News*, 5/1:18-24 (April 1990).
- Eriksson, L.G., and Pentz, D.L., 1989. "Geosciences and Geoengineering Challenges to Geologic High-Level Radioactive Waste Disposal in the United States of America," 28th International Geological Congress, Washington, D.C., July 1989.
- Eriksson, L.G., 1989. "Underground Disposal of High-Level Radioactive Waste in the United States of America - Program Overview," *Bulletin of the International Association of Engineering Geology* No. 39:35-51, prepared for Commission No. 14 of the IAEG (Second Report).
- Michalski, A., Eriksson, L.G., and Head, J., 1988. "Salt Rockbursts - A Function of Gas Enriched Zones and Effective Stress," *Second International Symposium on Rockbursts and Seismicity in Mines*, Minneapolis, Minnesota, June 1988 (Abstract).
- Eriksson, L.G., 1986. "Commentary on the Program for Final Disposal of High-Level Radioactive Waste in the United States of America," *Proceedings of the 5th International Congress of the IAEG*, Buenos Aires, Argentina, October 1986, 4:2751-2772, prepared for Commission No. 14 of the IAEG.
- Eriksson, L.G., and Michalski, A., 1986. "Hydrostatic Stress Conditions in Salt Domes - A Possible Reality or a Modeling Simplification?" *The International Symposium on Rock Stress and Rock Stress Measurements*, Stockholm, Sweden, September 1986.
- Schell, B.A., Eriksson, L.G., Murphy, B.E., Boylan, D., Kling, M., and Gregory, J.L., 1985. "Application of Seismotectonic Zoning to Regional Site Screening, Characterization and Selection," 28th Annual Meeting of the Association of Engineering Geologists, Winston-Salem, North Carolina, October 1985.
- Eriksson, L.G., 1983. "Geoplanning for Underground Space," *Underground Space*, 7:387-392.
- Zweifel, H.A., Hansen, D.E., and Eriksson, L.G., 1979. "Construction of the Near-Surface Test Facility: A Historical Perspective," *Basalt Waste Isolation Project (BWIP) Annual Report - Fiscal Year 1979*, prepared for the US Department of Energy by Rockwell International Corporation (RHO-BWI-79-100).
- Eriksson, L.G., 1978. "Rapid Subsurface Investigation System for Underground Openings and Space," *Third International Congress of Engineering Geology*, Madrid, Spain, September 1978.

ROBERT H. NEILL

Robert H. Neill has been the Director of New Mexico's Environmental Evaluation Group (EEG) since the Group's creation in 1978. The EEG performs an independent evaluation of the potential public health and environmental impact to New Mexico of the Waste Isolation Pilot Plant (WIPP) Project, for the disposal of defense transuranic waste. Prior to this, he served as a commissioned officer in the Bureau of Radiological Health of the U. S. Public Health Service for 23 years.

Mr. Neill received the degree of Mechanical Engineer from the Stevens Institute of Technology and an MS in Radiation Hygiene from the Harvard University School of Public Health.

Affiliations and Committees:

- Member, National Academy of Sciences, NRC, Committee to Evaluate Science, Engineering, and Health Basis of DOE's Environmental Management Program, Subcommittee on Priority Setting, Timing and Staging
- Member, National Academy of Sciences Panel on Uranium Mill Tailings
- Member, Advisory Committee on External Regulation of Department of Energy Nuclear Safety
- Member, Formerly Utilized Site Remedial Action Program Committee (FUSRAP) of the Environmental Management Advisory Board, U.S. DOE
- Member, EPA Advisory Committee on C-14 in High Level Waste Disposal
- Member, EPA Advisory Committee on Implementing WIPP Land Withdrawal Act
- Member, Environmental Information, Economics and Technology Committee of the National Advisory Council for Environmental Policy and Technology, U.S. EPA
- Member, Advisory Panel on DOE Generating Sites Environmental Cleanup, Office of Technology Assessment, U.S. Congress
- Member, Advisory Panel on Nuclear Weapons Dismantlement, Office of Technology Assessment, U.S. Congress
- Temporary Advisor, World Health Organization, Health Impacts of Different Energy Sources
- Temporary Advisor, World Health Organization, Health Effects of High-Level Wastes
- U.S. Representative, International Atomic Energy Agency visiting seminar on Environmental Radiation to Latin America
- Member Technical Advisory Committee on MRS, State of Tennessee
- Consultant, High Level Waste Task Force, Sierra Club
- Member, Institutional/Environmental Review Group, Crystalline Rock High Level Waste Project, Battelle National Laboratory
- Chairman, Radiological Health Section, American Public Health Association
- Consultant, National Academy of Sciences, National Research Council, Committee on Meteorological Aspects of Effects of Atomic Radiation
- Consultant, Radioactive Waste Workshop, Sierra Club

CHARLES FAIRHURST**EDUCATION**

B.Eng. (Mining Engineering, with First - Class Honours), 1952
Sheffield University, England

Ph.D. (Mining Engineering), 1955
Sheffield University, England

EXPERTISE

Rock Mechanics
Mining Engineering

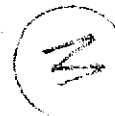
**PROFESSIONAL EXPERIENCE**

- Present** **T. W. Bennett Professor of Mining Engineering & Rock Mechanics**
University of Minnesota
- Chairman of the Board, Itasca Consulting Group, Inc.**
Minneapolis, Minnesota
- 1995 - Present** **Chairman, Peer Review to Atomic Energy of Canada Limited (AECL), on**
the Tunnel Sealing Experiment at the Underground Research Laboratory,
Pinawa, Canada
- Chairman, International Geomechanical Commission, invited by the**
French Government to study the effects of underground nuclear tests in
French Polynesia on the stability and hydrology of the atolls Mururoa and
Fangataufa
- Chairman, Working Group 4, Geosphere Modelling, for IAEA, Vienna, to**
study radionuclide releases from French nuclear tests in the Pacific
- 1993 - Present** **Member, Conseil Scientifique (Scientific Advisory Board), Laboratoire**
Mixte CNRS/LCPC, Marne La Vallée, France, on the Application of
Mathematics and Physics to Civil Engineering

CHARLES FAIRHURST

Page 2



PROFESSIONAL EXPERIENCE (continued)

- 1993 - Present Member, Conseil Scientifique (Scientific Advisory Board), ANDRA
(French Radioactive Waste Agency), France
- 1993 - 1995 Member, Committee on Technical Bases for Yucca Mountain Standards
U.S. National Academy of Sciences
- 1992 - Present Member, Conseil Scientifique de G.3S (Scientific Advisory Board),
Groupeement pour l'Etude des Structures Souterraines de Stockage
(Underground Waste Storage Group), Ecole Polytechnique, Palaiseau,
France
- 1989 - 1995 Vice Chairman, Board on Radioactive Waste Management (BRWM)
U.S. National Academy of Sciences
- 1989 - 1996 Chairman, WIPP (Waste Isolation Pilot Project) Committee, Board of
Radioactive Waste Management (BRWM)
- 1988 Chairman, Second International Symposium on Rockbursts & Seismicity
in Mines, University of Minnesota
- 1987 - 1992 Member, Rauma Co. (Finland), Scientific Advisory Group
- 1986 - Present Senior Editor, *Tunnelling and Underground Space Technology*
- 1985 - 1989 Member, Waste Isolation Pilot Project (WIPP) Advisory Panel, National
Academy of Sciences
- 1985 - 1986 Member, Conference Steering Committee, National Science Foundation
Initiatives in the States Program
- 1984 - 1985 Member, NAK (Sweden) Advisory Board on the WP-Cave Radioactive
Waste Isolation Concept
- 1983 Member, U.S. Environmental Protection Agency Advisory Sub-
Committee on Radioactive Waste Isolation

CHARLES FAIRHURST

Page 3

PROFESSIONAL EXPERIENCE (continued)

- 1983 Chairman, Engineering Review Group, Crystalline Rock Disposal Program, Office of Nuclear Waste Isolation, Battelle Laboratory, Columbus, Ohio
- 1983 Program Chairman, Subspace 83 Conference, Minneapolis
- 1982 Session Chairman, Subsurface 82, (U.N. Workshop on Utilization of Underground Space), Stockholm, Sweden
- 1982 - 1984 Chairman, National Science Foundation Advisory Sub-Committee on Civil and Environmental Engineering
- 1982 - 1985 Member, Engineering Advisory Board, National Science Foundation
- 1981 Program Chairman, Underground Space Conference and Exposition American Underground Space Association, Kansas City
- 1980 Session Chairman, Sub-Surface Space Symposium, Sweden
- 1978 - 1980 Member, National Science Foundation Review Panel, Division of Applied Research
- 1978 - 1980 Chairman, Committee on Rock Mechanics, American Society of Civil Engineers
- 1978 - 1979 Member, National Science Foundation Review Panel, Division of Policy and Analysis
- 1978 Member, Office of Science and Technology Policy Panel on U.S. Radioactive Waste Management Program
- Member, National Academy of Sciences/National Research Council Panel on Savannah River (Nuclear) Plant
- 1977 - 1978 Member, National Science Foundation, U.S. Centrifuge Facility Selection Panel

PROFESSIONAL EXPERIENCE (continued)

- 1977 - 1978 Member, National Academy of Sciences/National Research Council
Panel on Implementation Requirements of Environmental Standards
- 1977 Member, U.S. Delegation to the Soviet Union (NSF/AIME)
- 1976 - 1977 President, American Underground Space Association
- 1976 - 1986 Senior Editor, *Underground Space*, published by Pergamon Press, Oxford
- 1976 Member, National Science Foundation Advisory Panel on Engineering
Mechanics
- 1975 - 1978 Member, National Academy of Sciences Board on Mineral and Energy
Resources
- 1975 Chairman, National Science Foundation Workshop on Research
Opportunities in Mining
- 1974 - 1975 Chairman, Underground Construction Research Council, American
Society of Civil Engineers/American Institute of Mining Engineers
- 1974 Program Chairman, 3rd International Congress on Rock Mechanics
(Denver)
- 1974 Member, Commission on Research, International Congress on Rock
Mechanics (Denver)
- 1973 - 1974 Chairman, National Academy of Science/National Research Council
Committee on Feasibility of Returning Coal Mine Wastes to Underground
- 1973 - 1977 Member, U.S. Geological Survey Advisory Panel on Earthquake Research
- 1973 Member, Commission on Publications, International Society of Rock
Mechanics
- 1972 - 1987 Head, Department of Civil & Mineral Engineering, University of
Minnesota



04 20 81 10.01 012 312 4117 115503

CHARLES FAIRHURST

Page 5

PROFESSIONAL EXPERIENCE (continued)

- 1972 - 1974 Chairman, U.S. National Committee on Rock Mechanics, National Academy of Sciences
- 1971 Member, AEC (Oak Ridge National Laboratory) Advisory Panel on Radioactive Waste Disposal in Lyons Salt Mine, Kansas
- Member, National Academy of Sciences / National Research Council Advisory Panel on "Bedrock Disposal" (Underground Disposal of Radioactive Wastes)
- 1969 - 1973 Chairman, American Institute of Mining Engineers (AIME) Committee on Rock Mechanics
- 1969 Member, National Academy of Sciences / National Research Council Committee on Rock Mechanics
- 1966 - 1969 Member, American Society for Testing and Materials (ASTM), Subcommittee on Rock Mechanics
- 1965 - 1966 Publications Chairman, Rock Mechanics Section, *AIME (SME) Transactions*
- 1963 - 1970 Corresponding Member, International Buro of Rock Mechanics (Berlin)
- 1962 - 1966 Director (one of two from U.S.), International Society of Rock Mechanics (Salzburg)
- 1956 - 1964 Co-Chairman, Annual Symposia on Drilling and Blasting Rock Mechanics
- 1948 - 1956 Mining Engineer, National Coal Board, England
- 

CHARLES FAIRHURST

Page 6

PROJECT EXPERIENCE
(Itasca Consulting Group, 1981 - Present)



Charbonnages de France — Consultant on coal bumps in the mines of Lorraine and Provence (1992 - Present)

Spie Batignolles (France) — Member, Board of Experts, Guavio Hydroelectric Project (Colombia) (1985 - 1989)

Potash Mine Design, Mines Dominiiale de Potasse d'Alsace, Thailand (1981 - 1983)

Official Critic of Swedish Radioactive Waste Disposal Program, Ministry of Defense, Sweden (1978)

Geotechnical Advising, Lawrence-Berkeley Laboratories, Berkeley (1978)

U.S. Army Corps of Engineers, R. D. Bailey Dam (1977 - 1981)

Potash Mine Design, Petrobras Mineracao Corporation, Brazil (1975 - 1989)

Hydraulic Fracturing, Geothermal Energy, and Rock Blasting Studies, Los Alamos Scientific Laboratory, Los Alamos, New Mexico (1975 - 1981)

Lunar Drilling and Rock Blasting Programs, Martin Marietta Corporation (1973 - 1975)

U.S. Army Corps of Engineers, Niagara Falls Preservation Project (1968 - 1974)

Rock Drilling Research [at various times for Holman Brothers (Cornwall, England), Atlas Copco AB (Stockholm, Sweden), Tamrock (Tampere, Finland), HDRK Inc. Canada)]; Tunnel Lining Problems (at various times for Al Johnson Construction Company)

PROFESSIONAL AFFILIATIONS AND AWARDS

American Institute of Mining Engineers (AIME)

American Society of Civil Engineers (ASCE)

American Underground Construction Association (AUA)

International Society of Rock Mechanics

Sigma XI

U.S. National Committee on Rock Mechanics



Honorary Doctorate, University of Sheffield, England, 1997

Honorary Doctorate, National Institute of Lorraine (INPL), France, 1996

Honorary Doctorate, St. Petersburg, Mining Academy and Technical University, Russia, 1996

President, American Rock Mechanics Association (1995 - 1997)

Advisory Professor, Tongji University, Shanghai, China, 1995

President, International Society of Rock Mechanics (1991 - 1995)

Member, U.S. National Academy of Engineering, 1991

Theodore W. Bennett Professor of Mining Engineering and Rock Mechanics (1991 - Present)

E. P. Pfeider Professor of Mining Engineering and Rock Mechanics (1983 - 1991)

U.S. National Committee on Rock Mechanics Special Award

for "25 Years of Distinguished Achievements," 1983

Distinguished Professor of Mining Engineering and Rock Mechanics, University of Minnesota, 1982

Pergamon Medal, American Underground Space Association, 1981

Foreign Member, Royal Swedish Academy of Engineering Sciences, 1979

AIME Outstanding Achievement Award in Rock Mechanics, 1972

Inter-Society Committee on Rock Mechanics Medal for Best Mechanics Research Paper

Published in 1970 (with B. Haimson)

CHARLES FAIRHURST



SELECTED RECENT PUBLICATIONS

"Insights on the Stability of Large Excavations from Analytical and Numerical Models" (with C. Carranza-Torres and L. Lorig), *Felsbau*, 15(1), 45-63 (1997).

"A Model For the Time-Dependent Behavior of Rock" (with A. A. Fakhimi), *Int. J. Rock Mech. Min. Sci. & Geomech. Abstr.*, 31(2), 117-126 (1994).

"Analysis and Design in Rock Mechanics — The General Context," in *Comprehensive Rock Engineering*, Vol. 2, pp. 1-29. J. A. Hudson, Editor-in-Chief. Oxford: Pergamon Press Ltd., 1993.

"Evolving Towards 'Mechanics Based' Design Procedures in Geomechanics (Abstract)," in *Proceedings of the 1992 Rock Engineering Symposium in Taiwan (Tainan, Republic of China, December 1992)*, p. 1. S.-T. Chen et al., Eds. Tainan, Taiwan: National Cheng Kung University, 1992.

C. Fairhurst. "Three-Dimensional Discontinuum Modeling for Underground Excavations" (with L. Lorig), in *Proceedings of the 1992 Rock Engineering Symposium in Taiwan (Tainan, Republic of China, December 1992)*, pp. 349-358. S.-T. Chen et al., Eds. Tainan, Taiwan: National Cheng Kung University, 1992.

"Design of Excavations in High Rock-Stress Conditions," in *Rockbursts and Seismicity in Mines*, pp. 421-423. Rotterdam: A. A. Balkema, 1990.

"Micro-Computer Modelling and Practical Design/Monitoring of Large Underground Excavations," in *Static and Dynamic Considerations in Rock Engineering*, pp. 113-124. Rotterdam: A. A. Balkema, 1990.

"Verification and Validation of Coupled Mechanical/Water Flow Effects in Rock Masses: Some Possibilities and Limitations" (with R. D. Hart), in *GEOVAL-87 (Stockholm, April 1987)*, pp. 527-545. Stockholm: SKI, 1987.

"Comparison of Numerical Modeling with Predictions from Laboratory Tests and Field Observations of Deformation in a Potash Mine in Sergipe, Brazil" (with Alvaro Maia da Costa), in *Research and Engineering Applications in Rock Masses*, pp. 269-278. Boston: A. A. Balkema, 1985.

"Correlation of Numerical and Physical Models — An Approach to the Estimation of Rock Mass Properties" (with P. A. Cundall), in *Proceedings of the 34th Geomechanics Colloquium (Salzburg, Austria, October 1985)*.

"Fuzzy Methodology in Tunnel Support Design" (with Dezhang Lin), in *Research and Engineering Applications in Rock Masses*, pp. 269-278. Boston: A. A. Balkema, 1985.

Charles Fairhurst
Selected Publications
Page 2

"Rock Mechanics of Underground Excavations, General Report" (with B.H.G. Brady), in *Proceedings of the 5th International Congress of Rock Mechanics (Melbourne, 1983)*.

"Generalization of the Ground Reaction Curve Concept" (with E. Detournay), in *Proceedings of the 23rd U.S. Symposium on Rock Mechanics (Berkeley, August 1982)*, pp. 924-934. Littleton, Colorado: American Institute of Mining Engineers, 1982.

"Rock Fracture and Fragmentation, General Report" (with F. Cornet), in *Rock Mechanics From Research to Applications*, pp.21-46. Cambridge, Mass.: MIT, 1981.

"The Application of Mechanics to Rock Engineering (in French)," *Revue Français de Géotechnique (Paris)*, No. 1-45F TTC, 18-36 (July 1977).

"Going Under to Stay on Top," *Underground Space*, I, 71-86 (July-August 1976).

Dr. Fairhurst has some 75 additional publications and has supervised 20 Ph.D. theses and over 20 M.S. theses.





Reports

Fairhurst, C. "Optimization of the Rock Cutting Action of the HDRK-Wirth Hard Rock Continuous Mining Machine (Final Report)," ICG, Report to HDRK Mining Research Ltd., Rev. 1, April 1994.

Fairhurst, C., and J. P. Tinucci. "Findings for Anglo American Corporation's Rockburst Mitigation Program Review," ICG, Report to Anglo American, June 1992.

Asgian, M., M. Christianson and C. Fairhurst. "A Numerical Method for Predicting Fracture Crater Geometry for Simulation of Drill and Detach Excavation Methods," ICG, Report to Tampella (Finland), March 1984.

Fairhurst, C. "Comments on Proposed Finite Elements Modeling Study, Rock Mechanics Stability Study," ICG, Report to NAK/WP-Systems (Sweden), August 1984.

Bergman, S. M., and C. Fairhurst. "Working Paper: The Utilization of Subsurface Space and its Potential in Developing Countries," ICG, Report to the United Nations Natural Resources and Energy Division, Department of Technical Co-operation for Development, 1982.

Fairhurst, C. "Calculation of Time-Dependent Rock Swell In the Vicinity of the Nine Mile Point Unit 2 Reactor Excavation Over a 50 Year Period," ICG, Report to Dames & Moore (New York), June 1982.

William J. Roberds

Education	B.S. (with distinction), Civil Engineering, Stanford University, 1973. S.M., Geotechnical Engineering, Massachusetts Institute of Technology, 1975. Sc.D., Geotechnical Engineering, Massachusetts Institute of Technology, 1979.	
Affiliations	American Society of Civil Engineers (Geotechnical Safety and Reliability Committee). International Society of Rock Mechanics. International Association for Civil Engineering Reliability and Risk Analysis. Society for Mining, Metallurgy, and Exploration.	
Experience		
1980 to date	Golder Associates <i>Principal (previously Senior Geotechnical Engineer then Associate), Senior Risk and Decision Analyst, Manager of Systems Group)</i>	Redmond, Washington
1979 - 1980	University of Texas <i>Instructor, Geotechnical Engineering</i>	Austin, Texas
1976 - 1979	Massachusetts Institute of Technology <i>Research Assistant, Rock Mechanics</i>	Cambridge, Massachusetts
1975 - 1976	Geotechnical Engineers, Inc. <i>Senior Geotechnical Engineer</i>	Winchester, Massachusetts
1975	Duke University <i>Instructor, Geotechnical Engineering</i>	Durham, North Carolina
1973 - 1975	Massachusetts Institute of Technology <i>Teaching Assistant, Geotechnical Engineering</i>	Cambridge, Massachusetts
1972 - 1974	Dames and Moore <i>Geotechnical Engineer</i>	San Francisco, California

Professional Summary

Dr. Roberds is a Principal and Manager of the Systems Group at Golder Associates in Seattle, where he has been for the previous 16 years. He is a recognized international expert in probabilistic risk and decision analysis, with over 20 years of experience. He has been responsible for a wide range of local, national, and international geotechnical projects related to various aspects of siting, investigation, analysis, design, permitting, construction, monitoring, remediation and decommissioning of: (a) radioactive and other hazardous waste facilities; (b) civil engineering (rock slopes, tunnels, dams, embankments, and foundations, on-shore and off-shore); (c) mining engineering (underground openings, pit slopes, waste dumps, tailing dams, dewatering systems, and backfill schemes), and (d) water resources. Many of these projects were conducted under strict QA programs and included consideration of public safety, costs and other consequences, including associated risks. On the topic of probabilistic risk and decision analysis, he is a member of national committees, has been invited to speak at various conferences and to various public agencies (including various state and federal agencies), has presented numerous



William J. Roberds

workshops, has served as a reviewer for various professional journals, was invited to participate in a U.S. National Academy of Sciences workshop and was a keynote speaker at an international conference. In addition, he has published more than 40 papers and reports, has taught at several universities and previously worked for several other geotechnical consultants. Examples of relevant recent project experience includes:

ARCO

Alaska

Conducted workshop regarding risk assessment and risk management.

Waste Management Inc.

North America

Probabilistic cost estimates for remediation of two dozen Superfund sites throughout North America, considering the uncertainties in conditions, requirements and cost components.

BioRad

California

Risk assessment and decision analysis for disposition of contaminated industrial site.

Landfill Performance (EPA)

Developed model for probabilistically evaluating performance (leakage) of lined landfill systems.

Landfill Cover - Chemical Waste Management

Development of probabilistic model to evaluate landfill cover designs, in terms of likely total life cycle costs, considering possible failures (i.e., risks) due to uncertainties in static and dynamic conditions.

Dike Stability - Olin Chemical

Probabilistic analysis of stability of dikes adjacent to river at hazardous waste site, considering uncertainties in static and dynamic conditions (i.e., including seismic hazard analysis).

Water Supply

Moses Lake, Washington

Probabilistic analysis of investigation, remediation and supply options for a contaminated water supply, considering uncertainties in the current and future conditions and in the cost-effectiveness of the various alternatives, as input to a decision making framework.

Waste Disposal Facilities

Worldwide

Design, characterization and probabilistic analysis of the performance of underground radioactive waste disposal facilities for various clients throughout the world (e.g., NRC, EPA, NTS, WIPP, Yucca Mountain, BWIP, Salt, OCRD - US; NIREX - UK; AECL, Pt. Hope - Canada; NAGRA - Switzerland; SKB - Sweden; PNC - Japan; GSF - Germany), considering the uncertainties in site characteristics and future events.

New York Waste Facility

New York

Evaluation of various design options for disposal of low level radioactive waste, considering various factors such as cost, safety, socioeconomics, etc.

William J. Roberds

Waste Disposal System - US Congressional Commission

Probabilistic analysis of the total life cycle cost and schedule of specific proposed radioactive waste disposal systems, considering the uncertainties in costs and durations of the various activities involved.

Mixed Waste Disposal - Westinghouse

Developed risk assessment and decision analysis methodology for optimizing the mixed waste disposal system at Hanford, Washington, and helped to evaluate performance of mixed waste landfill.

Waste Disposal Regulations

United States

Assisted in the development and review of regulations governing radioactive waste disposal for various agencies (e.g., NRC, EPA, DOE, EPRI).

Probabilistic Health Risks - US Army Corps of Engineers

Assistance in development of probabilistic performance assessment model for estimating health risks to the public resulting from specific contaminated areas at Hanford, Washington.

Dose Reconstruction - Battelle - PNL

Assistance in conducting retrospective probabilistic health risk assessment at Hanford, Washington.

Underground Waste Disposal Facility - US Department of Energy

Development of probabilistic model to evaluate the likely consequences (risks) of various strategies for developing an underground waste disposal facility, in terms of total life cycle costs, schedules, and facility performance.

Tunnel Construction

Storebaelt, Denmark

Probabilistic risk analysis for the construction of major subsea tunnels, in terms of additional costs, schedule delays, worker safety and environmental impacts, considering a comprehensive set of failure modes and possible risk reduction strategies.

Tunnel Construction - CBM

Hong Kong

Probabilistic risk analysis for the construction of major subsea tunnels, in terms of schedule delays, worker safety and surface subsidence, considering a comprehensive set of failure modes as well as significant geologic uncertainties and current operating procedures/contingencies.

Environmental Data Base - Sandia National Labs

Development of an interactive data base for selecting optimal environmental remediation designs for specific user-defined problems, including reviews of environmental remediation needs and capabilities in various countries overseas.

Underground Test Facility - US Department of Energy

Probabilistic analysis of groundwater and methane inflow to an underground test facility during construction, considering the uncertainties in geologic and hydrogeologic conditions as well as construction procedures.

William J. Roberds

Wismut

Germany

Decision analysis for remediation of uranium mill tailings, considering tradeoffs among various factors including long-term health risks.

Ok Tedi Mine

Papua, New Guinea

Developed a probabilistic model and conducted probabilistic risk analysis associated with operation of various waste disposal system options for a large open pit copper mine, considering likely costs, worker/public hazards, environmental and socioeconomic impacts over the entire region.

Slope Stability

North America

Conducted risk assessment regarding slope stability of open pit mines throughout North America (e.g., Barrick, Twin Buttes, Kennecott/Bingham)

Golden Sunlight Mine

Montana

Risk assessment and decision analysis for remediation of an operating mine facility which was experiencing major failure, considering the uncertainty in current conditions, the uncertainty in the effectiveness of various options, and tradeoffs among various consequences.

Coal Mine Subsidence

Bellevue, Washington

Developed a probabilistic model and conducted probabilistic risk analysis associated with development above abandoned coal mines, considering potential subsidence and land use, expressed in terms of the likely cost of structural damage and the likely number of injuries.

Rio Algom Mines

Canada

Developed a probabilistic model for evaluating the long term effects (risks) of various options for decommissioning a uranium mine tailings facility, considering the uncertainties in site conditions and future events (e.g., storms, etc.).

Crown Mines

South Africa

Developed a risk assessment model for a proposed tailings dam in urban environment.

Mt. Isa Mine

Australia

Helped develop risk assessment and decision analysis model for evaluating alternative underground mine backfill schemes.

Territorial Government

Hong Kong

Developed methodology for conducting risk assessment and risk management for natural slopes throughout Hong Kong.

Rockfalls

North America

Conducted probabilistic risk analysis for rock falls along various transportation routes for various clients (e.g., ODOT, City of Vancouver, Pittsburgh, METRO, US Forest Service, etc.), considering the probability distribution for the number of rock falls and the likely consequences of each, and the effectiveness of design alternatives.

William J. Roberds

North Carolina Department of Transportation

Developed and applied probabilistic analysis procedures for rock slope stability analysis and design, and conducted a workshop in probabilistic and decision analysis for rock slopes (co-sponsored by the US Federal Highways Administration).

North Carolina

CN Rail

Conducted risk assessment and decision analysis to decide among various track remediation schemes, which included potentially significant public impacts.

Canada

TLNG

Risk assessment and risk management study for a proposed LNG plant in Trinidad.

Trinidad

Off-shore Platform

Probabilistic analysis of the stability of off-shore caisson-retained oil production facility in the Arctic, considering various potential failure modes and their likelihoods.

Gulf-Canada

Selected References

Roberds, W. and K. Ho, "A Quantitative Risk Assessment and Risk Management Methodology for Natural Slopes in Hong Kong," accepted for First International Conference on Debris-Flow Hazards Mitigation: Mitigation, Prediction and Assessment, ASCE, San Francisco, CA, August 1997.

Roberds, W. and K. Ho, "A Integrated Methodology for Risk Assessment and Risk Management for Natural Slope Landslides," submitted for IUGS Working Group on Landslides - Committee on Risk Assessment Workshop, Hawaii, February 1997.

Roberds, W., "Subtleties in Probabilistic Rock Slope Analysis," to be presented at ASCE 1996 Annual Convention and Exposition - Civil Engineers Influencing Public Policy, Washington, D.C., November 1996.

Roberds, W., C. Voss, A. Aubick, C. Kunze, and F. Pelz, "Multi-Attribute Decision Analysis of Remediation Options for a Uranium Mill Tailings Impoundment in Eastern Germany," American Nuclear Society, Proceedings of International Topical Meeting on Probabilistic Safety Assessment (PSA '96) - Moving Towards Risk Based Regulations, Park City Utah, September 29 - October 3, 1996.

Roberds, W., Development of a Quantitative Risk Assessment Methodology for Landslides on Natural Terrain in Hong Kong, report by Golder to Civil Engineering Department, Geotechnical Engineering Office - Special Projects, Hong Kong, August 1996.

Lockhart C. and W. Roberds, "Worth the Risk?", ASCE Civil Engineering, April 1996.

Roberds, W., G. Strayton, and J. Wates, "Risk Assessment for CMR Tailings Dam Complex," Proceedings of the Third International Conference on Tailings and Mine Waste '96, Fort Collins, Colorado, January 16-19, 1996, Balkema, Rotterdam, 1996.

Roberds, W., Risk-Based Methodology to Assist Decision Making on Remediation Options, report by Golder to Wismut GmbH, November 1995.

William J. Roberds

Roberds, W., Technical Risk Assessment and Decision Analysis Study, report by Golder to Trinidad LNG Project, Houston, TX, August 1995.

Goodale, B. A. Sutherland, C. Breeds, and W. Roberds, "A Detailed Comparative Evaluation of Six-Low-Level Waste Disposal Methods," *Waste Management* 95, Tucson, AZ, February 1995.

Roberds, W., "Decision Making Tools" and "Uncertainty in Risk Assessment," presented at workshop in Vancouver, B.C., November 1994.

Roberds, W., "Risk-Based Decision Making," presented at CIM District 6 AGM '94, 16th Annual Meeting, Vancouver, B.C., October 1994.

Kleinc, T., W. Roberds, A. Cameron, and B. Forryth, "The Use of Probability and Risk in Blast Design," in Nelson and Laubach (eds), Rock Mechanics Models and Measurements Challenges from Industry, Proceedings of the First North American Rock Mechanics Symposium, Austin, TX, Balkema, Rotterdam, June 1994.

Goodale, B., A. Sutherland, and W. Roberds, "Selecting a Preferred Low-Level Radioactive Waste Disposal Method for New York," *Waste Management* 94, Tucson, AZ, February 1994.

Roberds, W., "Probabilistic and Decision Analysis for Rock Slopes," presented as part of NCDOT/FHWA Rock Slope Engineering and Decision Analysis Short Course, Raleigh, NC, August 1993.

Roberds, W., "Probability Training Workshop," presented to WIPP Integrated Disposal Decision Alternatives Group, Albuquerque, NM, August 1993.

Roberds, W., "Comments on the Technical Basis for EPA HLW Waste Disposal Criteria," in Proceedings: EPRI Workshop I - Technical Basis for EPA HLW Disposal Criteria, EPRI Report TR-100347, pp. 435-471, March 1993.

Roberds, W., and A. DuCharme, "Evaluation of Grouting Technology: DOE Perspective," *EPA Spectrum* 92, San Francisco, CA, November 1992.

Roberds, W., "Integrated Risk Assessment and Risk Management in Mine Environmental Planning," presented at SME Risk Assessment/Management Issues in the Environmental Planning of Mines, St Louis, MO, October 1992.

DuCharme, A., W. Roberds and R. Jiminez, "Matching Leading DOE Waste Management and Environmental Restoration Needs with Foreign Based Technologies," report prepared by Sandia National Laboratories for US DOE - Office of Environmental Restoration and Waste Management - International Technology Exchange Program, October 1992.

DuCharme, A., R. Jiminez, and W. Roberds, "International Technology Transfer to Support the Environmental Restoration Needs of the DOE Complex," *Proceedings of the Nuclear and Hazardous Waste Management International Topical Meeting - Spectrum 92*, Boise, ID, August 1992.

Anderson, R., W. Roberds, and D. Banton, "Decision Analysis Model for Well Rehabilitation and Groundwater Development," *ASCE* Baltimore, MD, 1992.

William J. Roberds

Roberds, W., W. Haerer, and D. von Winterfeldt, "Decision Management for the Hanford Environmental Dose Reconstruction Project," invited paper, ANS/ASCE 1992 International High-Level Radioactive Waste Management Conference, Las Vegas, NV, April 12-16, 1992.

Roberds, W., "Probabilistic and Decision Analysis for Rock Slopes," presented at US Forest Service, Rock Slope Engineering Workshop, Eugene, OR, March 1992.

Roberds, W., "Environmental and Economic Risk Assessment/Management in Mine Development," invited paper, 1992 SME Annual Meeting and Exhibit, Phoenix, AZ, February 24-27, 1992.

Roberds, W., D. Banton, and R. Anderson, "Decision Analysis Model for Groundwater Rehabilitation and Development," paper presented at Northwest Water Resources Conference, Portland, OR, November 6, 1991.

Roberds et al, Project W-025 Landfill Hanford Site Liner Performance Operating Life Study, report by Golder to SAIC/Westinghouse Hanford, Richland, WA, September 1991.

Roberds, W., "Risk-Based Decision-Making Regarding Mixed-Waste Disposal Systems," ASCE International Symposium on Groundwater, Nashville, TN, July 29-August 2, 1991.

Burke, R., W. Roberds, and N. Norrish, "Phase I Design of a Slope Hazard Assessment System for Washington's Forested Land," report by Golder to Washington State Department of Natural Resources, June 1991.

Roberds, W., "Methodology for Optimizing Rock Slope Preventative Maintenance Programs," ASCE Geotechnical Engineering Congress, Boulder, CO, June 9-12, 1991.

Dershowitz, W., W. Roberds, and J. Black, "Application of Discrete Fracture Analysis to Site Characterization," ASCE Geotechnical Engineering Congress, Boulder, CO, June 9-12, 1991.

Roberds, W., I. Miller and D. Caldwell, "Evaluation of Alternative MGDS Development Strategies," ANS/ASCE 1991 International High Level Radioactive Waste Management Conference, Las Vegas, NV, May 1, 1991.

Roberds, W., "Testimony to USNRC-ACNW on Expert Judgment," January 1991.

Roberds, W. and D. Caldwell, Methodology for Evaluating Alternative Licensing Strategies: Development and Demonstration of Methodology, report by Golder for USDOE, Washington, D.C., November 1990.

Roberds, W., K. Haskell and W. Roberds, Feasibility Study for Landfill Cover Systems - Kettleman Hills Facility, report by Golder to Chemical Waste Management Inc., August 1990.

Roberds, W.J., M. Iwano, and H.H. Einstein, "Probabilistic Mapping of Rock Joint Surfaces," in Proceedings of Rock Joints, Regional Conference of the International Society for Rock Mechanics, Loen, Norway, June 4-6, 1990.

Roberds, William, J., "Methods for Developing Defensible Subjective Probability Assessments," Proceedings of Transportation Research Board, National Research Council, Washington, D.C., January 1990.

William J. Roberds

Roberds, W.J., "Risk-Based Decision Making Regarding Mixed-Waste Disposal Systems," Chapter in McTernan and Kaplan (eds), Risk Assessment for Groundwater Pollution Control, ASCE, April 1990.

Roberds, W. and W. Dershowitz, "Strategies for Hydraulic Characterization of a Repository Site in the Opalinus Clay and in the Lower Freshwater Molasse, Task 1: Methodology for Evaluation of Exploration Strategies," report by Golder Associates Inc. to NAGRA, NTB 90-36, Baden, Switzerland, 1990.

Dershowitz, W., J. Black and W. Roberds, "Strategies for Hydraulic Characterization of a Repository Site in the Opalinus Clay and in the Lower Freshwater Molasse, Task 4: Evaluation of Exploration Strategies for the Lower Freshwater Molasse and Opalinus Clay," report by Golder Associates Inc. to NAGRA, NTB 90-39, Baden, Switzerland, 1990.

Roberds, W., C. Breeds, and J. Byrne, Evaluation of Alternative ESF Shaft Construction Methods and Test Sequences for YMP, report by Golder to USDOE, August 1989.

Dershowitz, W., C. Breeds, W. Roberds, and I. Miller, Interim Spent Encl. Management Cost Data Base, report by Golder to Monitored Retrievable Storage Review Commission, Washington, D.C., June 1989.

Roberds, W., System Performance Assessment Approach for Mixed Waste Disposal, report by Golder to Westinghouse, February 1989.

Roberds, W. and I. Miller, The LF Landfill Reliability Computer Model, Part II: Theory, draft report submitted by Golder Associates to U.S. Environmental Protection Agency, Cincinnati, OH, December 1988.

Miller, I. and W. Roberds, The LF Landfill Reliability Computer Model, Part I: General Description, draft report by Golder Associates to U.S. Environmental Protection Agency, Cincinnati, OH, November 1988.

Roberds, W., "Reliability-Based Design of Mine Dewatering and Ventilation System," in Proceedings of Symposium on Reliability-Based Design in Civil Engineering, Lausanne, Switzerland, July 7-9, 1988.

Roberds, W., Manual for Conducting Subjective Probability Assessments, draft internal report by Golder Associates Inc., Redmond, WA, April 1988.

Roberds, W., Groundwater and Methane Inflow Study for the BWIP ESF at Hanford, WA, report by Golder to BWIP- Westinghouse Hanford, SD-BWI-DER-001, December 1987.

Roberds, W., Performance Assessment Plan for the Basalt Waste Isolation Project, report by Golder to BWIP- Westinghouse Hanford, SD-PAP-001 - Rev 2, August 1987.

Roberds et al. Draft Underground Test Plan for Site Characterization and Testing in an Exploratory Shaft Facility in Salt, report by Golder to ONWI-Battelle, Columbus, OH, May 1987.

Roberds, W. et al, "Probabilistic Analysis and Decision Making in the Applied Earth Sciences," short course presented by Geotechnical Group of Seattle Section of ASCE and the University of Washington, Seattle, WA, April 1987.

William J. Roberds

Kalia, H., W.J. Roberds, and R.I. Byrne, "Coupled Processes Addressed by Underground Testing for the Salt Repository Project," in Coupled Processes Associated with Nuclear Waste Repositories, Tsang (ed.), Academic Press, 1987.

Roberds, W.J., and D.L. Pentz, "Applications of Decision Theory to Hazardous Waste Disposal," paper presented at ASCE specialty conference GEOTECH IV in Boston, MA, October 1986.

Roberds, W.J., "Risk-Based Decision Making in Geotechnical Engineering: Overview and Case Studies," paper presented at Engineering Foundation Conference on Risk-Based Decision Making in Water Resources, Santa Barbara, California, November 3-8, 1985.

Roberds, W.J., R.L. Plum, and P.J. Visca, Proposed Methodology for Completion of Scenario Analysis for the Basalt Waste Isolation Project, Report No. RHO-BW-CR-147P, by Golder Associates Inc. to Rockwell Hanford Operations, November 1984.

Pentz, D.L., J.W. Voss, R. Talbot, and W.J. Roberds, Performance of Engineered Barriers in Deep Geologic Repositories for High Level Nuclear Waste (HLW) - Vol. 1: Summary and Recommendations - Final Report (Task 5), NUREG/CR-4026, final report by Golder Associates Inc. to U.S. Nuclear Regulatory Commission, September 1984.

Roberds, W.J., "In Situ Testing Requirements for High Level Nuclear Waste Deep Geologic Repositories," in Field Measurements in Geomechanics, Kovari (ed.), A.A. Balkema, Rotterdam, 1984.

Roberds, W.J., J. Voss, and D. Pentz, Technical Review on the Site Characterization Report (SCR) for the Basalt Waste Isolation Project (BWIP), final report by Golder Associates Inc. to State of Washington, April 1983.

Roberds, W.J., J. Kleppe, and L. Gonano, Evaluation of Engineering Aspects of Backfill Placement for High Level Nuclear Waste (HLW) Deep Geologic Repositories, NUREG/CR-3218, final report by Golder Associates Inc. to U.S. Nuclear Regulatory Commission, February 1983.

Roberds, W.J., et al. In Situ Test Programs Related to Design and Construction of High-Level Nuclear Waste (HLW) Deep Geologic Repositories, 2 vols., NUREG/CR-3065, final report by Golder Associates Inc. to U.S. Nuclear Regulatory Commission, November 1982.

Rawlings, G., G. Anttonen, M. Chamness, R. Hoffmann, W. Roberds, et al. Identification of Characteristics Which Influence Repository Design - Domain Salt, NUREG/CR-2613, final report by Golder Associates Inc. to U.S. Nuclear Regulatory Commission, March 1982.

Rawlings, G., G. Anttonen, D. Findley, R. Hoffmann, C. Soto, J. Rowe, F. Marinelli, W. Roberds, D. Pentz, and K. Jones, Identification of Characteristics Which Influence Repository Design - Tuff, NUREG/CR-2614, final report by Golder Associates Inc. to U.S. Nuclear Regulatory Commission, March 1982.

Roberds, W.J., "Risk Assessment Methodology for Geologic Repository of High Level Nuclear Waste," in Proceedings of Symposium on Uncertainties Associated with the Regulation of Geologic Disposal of High Level Radioactive Waste, NUREG/CP-0022, Oak Ridge National Laboratory, Tennessee, March 1982.

William J. Roberds

White, L., D.L. Pentz, W.S. Dershowitz, and W.J. Roberds, "Decision Analysis for Geologic Repository Development and Licensing," in Proceedings, International Conference on Radioactive Waste Management, Winnipeg, American Nuclear Society, 1982.

Roberds, W.J., Numerical Modeling of Jointed Rock, Sc.D. thesis submitted to Massachusetts Institute of Technology, August 1979.

Roberds, W.J., "Numerical Modeling of Rock Joints," in Proceedings of the 20th U.S. Symposium on Rock Mechanics, Austin, Texas, June 1979.

Roberds, W.J. and H.H. Einstein, "A Comprehensive Model for Rock Discontinuities," Journal of the Geotechnical Engineering Division, American Society of Civil Engineers, Vol. 104, No. GT5, May 1978.

Roberds, W.J. and H.H. Einstein, A General Purpose Elasto-Visco-Plastic Critical State Behavioral Model, M.I.T. Research Report R77-8 to the National Science Foundation, Massachusetts Institute of Technology, Cambridge, Massachusetts, March 1977.

Roberds, W.J., A Conceptual General Purpose Elastic-Plastic-Critical State Behavioral Model, S.M. thesis submitted to Massachusetts Institute of Technology, September 1975.

Plus numerous other presentations, workshops, and corporate reports on high level nuclear waste projects, system/risk analysis (for nuclear and hazardous waste projects and for civil/mining slope projects), and geotechnical (civil and mining) projects.

ORIGINAL

Revised. Aug. 1994

Biographical Data
Patrick Anthony Domenico, Professor
Department of Geology
Texas A & M University, College Station, Texas 77843

PERSONAL DATA:

Birthdate: January 10, 1932
Marital Status: Married
Social Security Number 095-20-8873

EDUCATION:

B.S. in Geology, Syracuse University, 1959 (Cum laude)
M.S. in Engineering Geology, Syracuse University, 1963 (Interdisciplinary Program, Civil Engineering and Geology). Thesis: Ground water hydrology of the Edmonton Formation in Central Alberta, supported by Alberta Research Council, Edmonton, Alberta, Canada
Ph.D in Hydrology, University of Nevada at Reno, 1967. (Interdisciplinary program, Geology, Civil Engineering, Economics) Dissertation: Valuation of a ground water supply for management and development

EXPERIENCE

Graduate Teaching Assistant, Syracuse University, Syracuse University, 1959-61

Assistant in Hydrology, Alberta Research Council, summer, 1960

Engineering Geologist, Dept, Water Resources, State of California, March 1962 to February, 1962. Engineering geology for dam sites, power plants, and other engineering structures associated with the Feather River Project.

Research Associate in Hydrology: Desert Research Institute, University of Nevada, February 1962-September, 1968. Teaching and research in ground water hydrology, with emphasis on simulation and optimization

Professor of Geology, University of Illinois at Champaign-Urbana, September 1968 to 1982. Teaching and research in ground water hydrology with emphasis on mass and energy transport in porous media

David B. Harris Professor of Geology, Texas A & M University, College Station, Texas, September 1982 to present. Teaching and research in ground water hydrology, emphasis on mass, energy, and contaminant transport in porous media

Information Only

PROFESSIONAL AWARDS

Recipient, Meinzer Award, distinguished contribution (paper) to Hydrogeology
1979, Geol. Soc. America

Recipient, Alexander Winchell Distinguished Alumni Award, 1980, Syracuse
University

Recipient, Basis Research Award (paper), 1983, U.S. National Committee
for Rock Mechanics

Recipient, Excellence in Science and Engineering Award (book), 1991,
Association of Ground Water Scientists and Engineers

Recipient, Distinguished Teaching Award, College of Geoscience, 1986,
The Association of Former Students of Texas A & M

Recipient, Faculty Distinguished Achievement Award in Teaching, 1989,
The Association of Former Students of Texas A & M

PROFESSIONAL RECOGNITION

Associate Editor, Water Resources Research (not current)

Associate Editor, Geology (not current)

Associate Editor, Geol. Soc. Amer. Bull. (not current)

Editorial Board, Journal of Ground Water (not current)

Birdsall Distinguished Lecturer in Hydrology, 1981-82, Geol. Soc. America

Visiting Lecturer, Univ. of Indiana, Spring 1965. Initiate a teaching and research
Program in ground water hydrogeology

Visiting Lecturer, Pennsylvania State Univ., 1970, two week of seminars on
optimization techniques in ground water hydrology

Visiting Scholar, Western Michigan Univ., 1993, Will deliver Public Plenary
Lecture

Invited speaker or discussion leader, Penrose Conferences on hydrogeology,
1973, 1974, 1975, 1976, 1984.

Co-convener of Penrose Conference on "Flow and associated transport in basins:
Driving forces, coupling, and geologic controls, 1991, Bodega Bay, CA.

PROFESSIONAL RECOGNITION (CONTINUED)

Participant, National Science Foundation Uranium Mill Tailings Study Panel, 1984-1985

Participant, Planning workshops for Hydrology Volume for the Decade of North American Geology (DNAG Series), 1983.

Two papers singled out for reproduction in "Benchmark Papers in Geology", 1983, one in Physical Hydrogeology, v. 72, another in Chemical Hydrogeology, v. 73

Published paper (Alternative boundaries in solid waste management, Groundwater, v. 20, p. 303-311) cited in congressional record and utilized by EPA in hazardous waste delisting

Presidential Appointment (President Bush) to the U.S. Nuclear Waste Technical Review Board, 1991-1994

Participant, National Academy of Science panel on assessing the future value of ground water (1994-1996)

OTHER ACTIVITIES

Registered Engineer, State of Nevada





MAJOR PUBLICATIONS

1. Domenico, P.A., and Stephenson, D., 1964. Application of quantitative mapping techniques to aid in hydrologic systems analysis of alluvial aquifers: *Jour. Hydrology*, v. 2, p. 164-181.
2. Domenico, P.A., and Clark, G., 1964. Electric analogs in time settlement studies: *Jour. Soil Mechanics, ASCE Proc.*, v. 90, no. SM3, p. 33-51.
3. Domenico, P.A., and Mifflin, M., 1965. Water from low-permeability sediments and land subsidence: *Water Res. Research*, v. 1, no. 4, p. 563-576. Reprinted in *Benchmark Papers in Geology*, v. 72, Physical Hydrology, Ed. Freeze and Back, 1983.
4. Domenico, P.A., Mifflin, M., and Mindling, A., 1966. Geologic controls on land subsidence in Las Vegas Valley: *Idaho, Proc., Eng. Geology and Soils Eng. Symposium*, April 1966, p. 113-121.
5. Domenico, P.A., 1967. Economic aspects of conjunctive use of water, Smith Valley, Nevada: *Symposium of Haifa, Internatl. Assoc. Sci. Hydrologists*, Pub. no. 72, p. 474-482.
6. Domenico, P.A., Anderson, D.V., and Case, C.M., 1968. Optimal ground water mining: *Water Res. Research*, v. 4, no. 2, p. 247-255.
7. Domenico, P.A., 1972. *Concepts and models in groundwater hydrology*: McGraw Hill Book Co., New York, N.Y., 405 p.
8. Schwartz, F.W., and Domenico, P.A., 1973. Simulation of hydrochemical patterns in regional groundwater flow: *Water Res. Research*, v. 9, no. 3, p. 707-720. Reprinted in *Benchmark Papers in Geology*, v. 73, Chemical Hydrology, Ed. Back and Freeze, 1983.
9. Palciauskas, V.V. and Domenico, P.A., 1973. On the optimal operation of groundwater basins: *Jour. of Hydrology*, 20, p. 181-189.
10. Domenico, P.A., and Palciauskas, V.V., 1973. Theoretical analysis of forced convective heat transfer in regional groundwater flow: *Geol. Soc. Amer. Bull.*, v. 84, p. 3803-3814.
11. Palciauskas, V.V., and Domenico, P.A., 1976. Solution-chemistry mass transport, and the approach to chemical equilibrium in porous carbonate rocks and sediments: *Geol. Soc. Amer. Bull.*, v. 87, p. 207-214.
12. Sharp, J.M., and Domenico, P.A., 1976. Energy transport in thick sequences of compaction sediment: *Geol. Soc. Amer. Bull.*, v. 87, p. 390-400. (Recipient, O.E. Meinzer Award, 1979).
13. Domenico, P.A., 1977. Transport phenomena in chemical rate processes in sediments: *Ann. Rev. Earth and Planet. Sci.*, v. 5, p. 287-317.
14. Domenico, P.A., and V.V. Palciauskas, 1979. Thermal expansion of fluids and fracture initiation in compaction sediments: *Geol. Soc. Amer. Bull.*, Part I, v. 90, p. 518-520; Part II, p. 953-979.

15. Domenico, P.A., and V.V. Palciauskas, 1979, The volume averaged mass transport equation for chemical diagenetic models: *Jour. of Hydrology*. The George Burke Maxcy Volume, v. 53, p. 427-438.
16. Palciauskas, V.V., and Domenico, P.A., 1980, On microfracture development in compacting sediments and its relation to hydro-carbon maturation kinetics: *Amer. Assoc. Petrol. Geol. Bull.*, v. 64, p. 927-937.
17. Domenico, P.A., V.V. Palciauskas, 1982, Alternative boundaries in solid waste management: *Groundwater*, v. 20, p. 303-311.
18. Palciauskas, V.V., and Domenico, P.A., 1982, Characterization of drained and undrained response of thermally loaded repository rocks, *Water Resources Research*, v. 18, p. 281-290. (Recipient, Basic Research Award of the U.S. National Committee for Rock Mechanics, 1983).
19. Domenico, P.A., 1983, Determination of bulk rock properties from groundwater level fluctuations: *Bull. Assoc. Eng. Geol.*, v. 20, no. 3, p. 283-287.
20. Domenico, P.A., and G.A. Robbins., 1984, A Dispersion scale effect in model Calibrations and field tracer experiments: *J. of Hydrology*, v. 70, p. 123-132.
21. Robbins, G.A., and Domenico, P.A., 1985, Determining dispersion coefficients and sources of model dependent scaling: *J. of Hydrology*, v. 75, p. 195-211.
22. Domenico, P.A., and Robbins, G.A., 1985, The displacement of Connate water from aquifers, *Geol. Soc. Amer. Bull.*, v. 96, - 328-335.
23. Domenico, P.A., and Robbins, G.A., 1985, A new method of contaminant plume analysis: *Groundwater*, v. 23, p. 476 - 485.
24. LaVenue, A.M. and P.A. Domenico, 1986, A Preliminary assessment of regional dispersivity in selected basalt flows at the Hanford Site, Washington, U.S.A., *J. of Hydrol.*, v. 85, p. 151-167.
25. Nat. Acad. Sci Pub., 1986 Scientific Basis For Risk Assessment and Management of Uranium Mill Tailings. Nat. Aca. Sci Press (11 authors)
26. Domenico, P.A., 1987, An analytical model for multidimensional transport of a decaying contaminant species, *J. Hydrol.*, v. 91, p. 49-58.
27. Domenico, P.A., 1988, Groundwater as a geologic agent, Chapter 41, *The Geology of North America*, v. 0-2, Hydrogeology eds. Back, W., Rosenshein, J.S. and Seabor, P.R., Geol. Soc. Amer. p. 381-382.
28. Domenico, P.A., and V.V. Palciaskas, 1988. The generation and dissipation of abnormal fluid pressures in active depositional basins. Chapter 45. *The Geology of North America*, V. 0-2, Hydrogeology, eds. Back, W., Rosenshein, J.S., and Seabor, P.R., Geol. Soc. America. p. 435-445.
29. Lerman, A., Domenico, P.A., and J.W. Bartlett, 1988, Evaluation of disposal site geochemical performance using a containment factor. *Proc. of the symposium on waste management at Tucson, Arizona*, ed. R.G. Post, II, p. 633-638.

MAJOR PUBLICATIONS (CONTINUED)

30. Palciauskas, V.V. and P.A. Domenico. 1989. Fluid pressure in deforming porous rock. *Water Resources Research*, v. 25, p. 203-213.
31. Domenico, P. A., Lerman, A., and Bartlett, J.W.. 1989. The disposal of nuclear waste-A problem in mass management? *Ground Water*, v. 27, p. 363-383.
32. Fryar, A.E. and P.A. Domenico. 1989. Analytical inverse modeling of regional scale tritium waste migration. *J. Contaminant Hydrol.* v. 4, p. 113-125
33. Domenico, P.A. and F.W. Schwartz. 1990. *Physical and Chemical Hydrogeology*. J. Wiley & Sons, N.Y. 824 p. (Recipient, Excellence in Science and Engineering Award, 1992).
34. Aja, N.K. and P.A. Domenico. 1992. Inverse analytical techniques applied to coincident contaminant distributions at Otis Air Force Base, Massachusetts. *Ground Water*, v. 30, p. 212-218
35. Lerman, A. and P. A. Domenico. 1993. Dissolved and gaseous contaminant transport in salt deposits. *Chemical geology*, v. 107, p. 427-429



OTHER PUBLICATIONS AND CIRCULATED REPORTS

1. Domenico, P.A., Stephenson, D., and Maxey, G.B., 1962. Geological, geophysical, and hydrological investigations of the Sand Springs Rangfor the shoal event: Nevada Bureau of Mines, Mining Laboratory, and Desert Research Inst., p. 47-70, 98-112.
2. Domenico, P.A., 1963, Role of electric analog computer on ground water management: Proc., 32nd Ann. Natl. Reclamation Assoc., Sun Valley, Idaho, p. 37-39.
3. Domenico, P.A., Stephenson, D., and Maxey, G., 1964, Ground water in Las Vegas Valley: Desert Research Inst. Tech. Rept., No. 7, 53 p.
4. Mifflin, M.D., Maxey, G.B., Domenico, P.A., et al. 1964, Hydrological investigations of the Sand Spring Range, Fairview Valley and Four mile Flat, VELA UNIFORM PROJECT SHOAL, ATOMIC ENERGY COM. report VUF 1001, p. 238-264.
5. Domenico, P.A., Schulke, D., Merkel, J., and others, 1965. Operation plan for the Humboldt River Project: Div. of Water Resources, Nevada Dept. of Conservation, in conjunction with Humboldt Eng. Assoc., 24 p.
6. Schulke, D., Domenico, P., and Maxey, G.B., 1966, Analog computer for hydrologic research: Center for Water Res. Research, Desert Research Inst., Univ. of Nevada, Pub. no. H-W 1, 30 p.
7. Domenico, P.A., 1967, Valuation of ground water supply for management and development: Center for Water Res. Research, Desert Research Inst., Univ. of Nevada, Pub. no. 3, 46 p.
8. Case, C.M., Domenico, P.A., Zeizel, E.P., and Crouse, L., Ground water use in stabilizing surface water supply, 1969, Proc., Eng. Geol. and Soils Eng. Symposium, April, 1969, Moscow, Idaho, p. 101-115.
9. Domenico, P.A., 1970, Notes on the interpretation and application of information theory in hydrogeologic research: Geol. Soc. Amer. Discussion Paper, Milwaukee, Wis., 1000 word abstract.
10. Domenico, P.A., Freeze, R.A., Neuman, S.P., Parker, F.L., Pearson, F.J., Tanaka, H., 1981, Hydrology overview Committee Repot., Basalt work Isolation Group, Rockwell International, Richland, WA, Pub. RHO-BWI-LD-50.





Other Publications and Circulated reports (Continued)

11. Domenico, P.A., G.E.Grisak, F.W. Schwartz, 1995. Expert panel on hydrogeology report to AECL research: AECL -11268, COG 95-64, Whiteshell Laboratories, Pinawa, Manitoba. ROE 110

THESIS SUPERVISION

1. Groundwater hydrology of Iroquois County (M.S.) A. Hamdan
2. An investigation of the effects of modified stream flow of the Sangamon River on the adjacent flood plain (M.S.) Annene Price
3. Cross sectional groundwater flow model of the Sheffield Illinois low level radioactive waste disposal site (M.S.) Leah Rogers
4. Groundwater flow and nutrient uptake in Las Vegas Wash, Las Vegas Valley, Nevada (M.S.) A. Schmidt
5. Effect of shallow groundwater flow systems on rock and soil temperatures (Ph.D.) K. Cartwright
6. Digital simulation of an outwash aquifer in Nova Scotia (Ph.D.) L. Lin
7. Digital simulation of hydrochemical patterns in regional ground-water flow (Ph.D.) F. Schwartz
8. Finite element approach to modeling hydrothermal systems (Ph.D.) J. Mercer
9. Investigation of energy transport in thick sequences of compacting sediment (Ph.D.) J. Sharp
10. The Long Island groundwater reservoir - a case study in anisotropic flow (Ph.D.) R. Getzen
11. Finite element modeling of salt water intrusion, Hermosillo, Mexico (Ph.D.) R. Andrews
12. Digital simulation of compaction (Ph.D.) Y.P. Chia
13. Hydrogeology of the Don Juan Basin, A Dry Valley in Antarctica. (Ph.D.) H. Harris
14. Fluid and energy transport in a high level radioactive waste repository located in unsaturated alluvium (Ph.D.) D. Pollock
15. Determining dispersion coefficients from a landfill leachate Plume (M.S.) S. Strautman.
16. Field determination of dispersivity of comingling plumes (M.S.) V. Kelley.
17. A Preliminary assessment of the regional dispersivity of the Hanford Basalts (M.S.) A. Lavenue
18. Determination of dispersivities from a natural gradient dispersion test (M.S.) Caroline Hoover.
19. Determination of transport parameters from coincident chloride and tritium plumes at the Idaho National Engineer Labwater (M.S.) A. Fryar.
20. Transport parameter determination and modeling of sodium and strontium plumes at the Idaho National Engineering Laboratory (M.S.) J. Londergan.

- 
21. Parameter determination and transport modeling of coincident inorganic and organic plumes at the Savannah River Plant (M.S.) T. Cauffman
 22. A post mortem performance assessment of a high level radioactive waste repositing. Handord Site, Washington (M.S.) R.H. Petrini.
 23. The effect of multiple source loading on the determination of transport parameters (M.S.) D.W. Hankins.
 24. Investigation of leaking underground storage tanks in the Texas Gulf Coast Region: Legislation, Characterization, and remediation (M.S.) D. Upton.
 25. Computer adaptation of an inverse solution technique to the analytical contaminant transport equation (M.S.) Timothy Dale
 26. Simulated effects of changes in the infiltration rate and the hydraulic conductivity structure on the location and configuration of the water table at Yucca Mountain, Nevada (M.S.) N. Jasek
 27. An inverse analytical technique applied to solute transport observations at Otis Air Force Base, Cape Cod, Massachusetts (M.S.) N. Ala
 28. Determining dispersion parameters to predict ground water contamination (Ph.D) G. Robbins
 29. A theoretical approach for assessing the role of rock and fluid properties in the development of abnormal pressures (M.S.) T. Hastings
 30. Determination of the transport parameters and construction of the salt water concentration contour map for the Brunswick, Georgia plume (M.S.) J. Mersky
 31. A solute transport model calibration procedure as applied to a tritium plume in the Savannah River Plant F area, South Carolina (M.S.) D. Edwards
 32. An analysis of the connectivity of two dimensional fracture patterns at Yucca Mountain, Nevada (M.S.) H. Meinardus
 33. Application of multidimensional analytical transport models to coal tar derivatives (M.S) Youn Sim

THESES SUPERVISION (CONTINUED)

34. An inverse analytical technique applied to chloride contamination of ground water at Indian School and Levering sites. Michigan (H. Shumway) M.S.
35. Modeling the reactive inorganic solute distributions of the Hanford Site using inverse analytical modeling techniques (M. Adamski) M.S.
36. Development of source functions for modeling dissolution of residual DNAPL fingers in the saturated zone (B. Johnson) M.S.
37. Quasi three dimensional ground water modeling of the hydrologic influence of Paleozoic rocks on the ground water table at Yucca Mountain, Nevada (Si Yong Lee) M.S.

PARTIAL LIST OF PROFESSIONAL AND CONSULTING ACTIVITIES



Engineering Geology and Deep Well Dewatering Design

Land subsidence in Las Vegas Valley in relation to the proposed Interstate Highway 15 (1964)

Engineering geology of Nevada Power Company Plant, Moapa Valley, Nevada (1965)

Deep well dewatering design for the Reno-Sparks Intercepting Sewer (1966); the wet section of the San Fernando Tunnel (1968); Rock Creek Tunnel (1970); Milwaukee Sewer Tunnel (1971); and the Esliirp Tunnel Project (1975).

Groundwater Supply

Optimization and simulation for groundwater management of the salt water intrusion zone, Costa de Hermosillo, Mexico (1974-1975)

Groundwater supply for agriculture development, Work Bank Small Scale Agriculture Infrastructure Project, Appraisal Mission, Mexico (1978)

Groundwater supply for proposed nuclear power plant, Mason Valley, Nevada (1965); Nevada Power Company Plant, Moapa Valley, Nevada (1965); Agrochemical Company, Florida (1973); and proposed utilization of southern Florida salt water zone for cooling purposes (1975)

Geothermal

Well design and technical specifications for hot water wells, Sierra Nevada foothills, Nevada (1967)

An evaluation of the thermal pressure producing mechanisms, Dome Fault area, Utah (1975)

Environmental

Potential impact of surface mining on the quality of surface and groundwater resources in Knox County, Illinois (1978)

Impact of Mallard Lake Landfill on groundwater quality, Chicago, Illinois (1979)

Dewatering requirements and environmental considerations for underground storage in the Galena-Platteville carbonate rock system, Elmhurst-Chicago quarry (1979)

Potential impact of utilizing Silurian dolomite as a medium for a sanitary landfill, Chicago (1979)

Panel reviewer for geologic studies, Nevada Nuclear Waste Storage Program (1979)

Panel reviewer for hydrologic studies, Basalt Nuclear Waste Isolation Program, Richland, Washington, (1979)

Development of contaminant transport models for solid waste facilities,
Edison Electric Institute (1979)

Assistance in developing mass transport models for solid waste facilities,
DuPont Chemical Co. (1980)

Site investigation and remedial design, leaky underground storage
tank, South Texas.

Performance assessment of domal salt as a repository for solidified
hazardous waste, North Dayton Dome facility, Texas

Performance assessment of domal salt as a repository for hazardous
waste, Boling Dome facility, Texas.

Review of no migration petitions (five years), EPA, Chicago

Consultant to Oak Ridge Nat. Lab. on matters of hazardous waste and
remediation measures

Consultant to Municipality of Waterloo, Ontario, Canada, on matters of
ground water supply and contamination control. (Current)

Consultant to legal firms involved in hydrocarbon leakage from major tank
farms, Albuquerque, NM and Austin, TX (current)

Consultant to legal firms concerned with migration of hazardous waste from
a hazardous waste facility, San Diego, CA. (current)

3

Paul E. Drez
Drez Environmental Associates
8816 Cherry Hills Road, NE
Albuquerque, NM 87111
(505)-828-9857

Professional Qualifications

Dr. Drez is a geochemist with over 19 years of post-graduate professional experience interacting with both government and private industry. In his current function for Roy F. Weston/ASI, Dr. Drez is a Senior Consultant to DOE on technical aspects of the WIPP Project, particularly in the area of radioactive waste inventories. The major accomplishments of Dr. Drez for the WIPP Project includes the following: Primary author of the Technical Needs Assessment Document to define the technical data needs of the Gas-Generation and Source-Term Programs; Chairman of the Independent Peer Review Panel and Primary Author for Revision 4 of the WIPP Waste Acceptance Criteria; and Project Manager and Primary Author of the Safety Analysis Report for the TRUPACT-II package designed to transport waste to the Waste Isolation Pilot Plant (WIPP) in New Mexico. Dr. Drez was also technical manager for the Engineered Alternatives Task Force and was a primary author on the No-Migration Variance Petition and the WIPP Waste Characterization Program Plan. Dr. Drez is a DOE technical expert for TRU waste forms present across the DOE complex and has been the technical lead for developing the WIPP Transuranic Waste Baseline Inventory Report (currently issued as Revision 3), which defines the waste inventory for all WIPP-related documents to regulatory agencies.

Education

Ph.D., Geochemistry, University of North Carolina, Chapel Hill, North Carolina; 1977
B.S., Chemistry, Old Dominion University, Norfolk, Virginia; 1969

Registrations/Certifications

DOE Q Clearance, Inactive

Experience and Background

1992 - Present *Consultant, Drez Environmental Associates, Albuquerque, New Mexico.* As an Independent Consultant, Dr. Drez's main contract is with Roy F. Weston/Advanced Science, Incorporated for support to the WIPP DOE Carlsbad Area Office (CAO). Dr. Drez's responsibilities under the contract include:

- Technical lead on the development of the Transuranic Waste Baseline Inventory Report (TWBIR), which is the first document to ever define all transuranic waste in the DOE system in terms of waste streams and the physical/chemical composition of the waste streams. The TWBIR is the document that defines the transuranic waste inventories in all documentation sent to regulatory agencies supporting the compliance applications to open WIPP for disposal of transuranic waste by June 1998.



- Support DOE-HQ in development of the Programmatic Environmental Impact Statement (PEIS). This effort includes the definition of alternative treatment and storage options for transuranic (TRU) and mixed-TRU (MTRU) wastes based on previous experience in TRU programs, development and justification for source terms to be used in PEIS risk assessment evaluations.
- Support DOE-HQ for modification of the Interim Mixed Waste Inventory Report (IMWIR) and comparison of the IMWIR data with that previously published in support of the WIPP compliance activities. The activity includes comparison of the IMWIR report with the Integrated Database for consistency; documenting inconsistencies in data and recommending changes to the questionnaires in support of resolving the inconsistencies.
- Technical manager and primary author of the "Gas-Generation and Source-Term Programs: Technical Needs Assessment for the Waste Isolation Pilot Plant" document (TNAD). The TNAD revises the scope and technical approach of the GGP (as originally developed by Sandia National Laboratory/New Mexico) and defines the STP. The TNAD will be submitted to external regulatory agencies as technical justification of the GGP and STP that are defined in the revised WIPP Test Phase Program.
- Member of the Rocky Flats Plant(RFP)/WPIO Efficiencies Working Group. This group is evaluating several options for the disposition of plutonium-bearing residues currently in storage at RFP. Dr. Drez's function in this group is to evaluate each type of residue (over 100) for changes in waste form or packaging that would allow greater quantities of the residues to be shipped in TRUPACT-II.

1988 -
1992

Senior Technical Associate and Group Manager, Waste Characterization, International Technology Corporation (IT), Albuquerque, New Mexico. As Manager of the Transuranic and Mixed Waste Assessment Group, Dr. Drez managed a staff of 12 scientists and environmental engineers providing waste characterization support to the ten DOE TRU waste generator/storage sites, including the Rocky Flats Plant, Oak Ridge National Laboratory, Hanford, Savannah River Plant, Los Alamos National Laboratory, and others. For the WIPP, Dr. Drez has been a major contributor to several concurrent R&D programs including the Engineered Alternatives Task Force (EATF), Performance Assessment, Final Supplement Environmental Impact Statement (FSEIS), No-Migration Variance Petition (NMVP), Five-Year R&D Test Plan, and licensing of the TRUPACT-II and remote-handled (RH) waste transportation systems. His recent activities have included the following:

- Member of the DOE Bin Preparation Task Force established to oversee preparation of the experimental waste for the WIPP. Dr. Drez was a primary author of the Pretest Waste Characterization Program Plan, applicable to the

characterization of this experimental waste. This document will also serve as a template for future waste characterization activities at DOE sites.

- Appointed by DOE as Technical Director for the EATF, which was organized to develop and evaluate engineered alternatives that could be implemented to help demonstrate compliance with 40 CFR, Part 191 (Performance Assessment) and 40 CFR Part 268 (RCRA No-Migration Variance Petition) at the WIPP facility. The alternatives considered could be applied to the waste form, the repository underground design, or passive marker systems emplaced at the surface of the facility. Each alternative was assessed for technical, siting, and permitting feasibility; cost factors; how it would affect the WIPP schedule; and transportation issues. Each proposed alternative was evaluated for compliance using deterministic models developed by the IT-Albuquerque office in support of the EATF. The program represented a 12 man-month/month effort over 24 months with a budget of \$3.2 million.
- Responsible for initial application of extensive work on TRU waste (e.g., Engineered Alternatives Task Force and Waste Acceptance Criteria) to low-level and low-level mixed waste for DOE-HQ.
- Dr. Drez was Chairman of the Independent Peer Review Panel (IPRP) that revised the Waste Acceptance Criteria (WAC) for WIPP. Revision 4 consolidated all known criteria into one concise document, including transportation, RCRA, PA, and state of New Mexico requirements.
- Technical Director and Project Manager for all waste characterization studies in support of the Safety Analysis Report for Packaging (SARP) to obtain a Certificate of Compliance for the TRUPACT-II shipping container for transporting contact-handled transuranic (CH-TRU) mixed hazardous waste to the WIPP site for disposal. Dr. Drez was the primary representative for DOE and Westinghouse (prime contractor) at pre-SAR meetings and post-SARP hearings on the TRUPACT-II with the Nuclear Regulatory Commission. The Certificate of Compliance for the TRUPACT-II was awarded in August 1989. Dr. Drez continued to coordinate work on amendments to the TRUPACT-II SAR.
- Technical Director and Project Manager for all waste characterization studies on payload issues for the SARP to obtain a Certificate of Compliance for the 72B cask to ship RH-TRU mixed hazardous waste to the WIPP site for disposal.
- Technical Advisor to Westinghouse, DOE, and nuclear waste generator sites on waste characterization and testing methods to meet NRC and EPA regulations.



- Characterization and definition of the first-ever TRU waste inventory of radionuclide and nonradionuclide constituents for Sandia National Laboratories.
- Extensive experience in writing test plans to address technical problems by identifying the issues, formulating tests to gather pertinent data, and offering techniques for the evaluation of data to resolve the issues.

1986 -
1988

Senior Geochemist, International Technology Corporation (IT), Albuquerque, New Mexico.
Dr. Drez was an active participant in the WIPP performance assessment project, modeling of deep well injection fluid interactions, and gas generation studies of mixed-hazardous waste for transportation and disposal.

- Technical presentations before the National Academy of Sciences in support of WIPP performance assessment for Sandia National Laboratories and the DOE.
- Technical Consultant on mobility of uranium in surface soils and subsurface ground waters at the Fernald site. Specification of sampling and differential leaching techniques to characterize mobile uranium fractions in samples.
- Integrated organic-metal complexes into geochemical modeling programs (EQ3/6 and PHREEQE) to predict the effects of organic ligands on metal speciation and mobility, and the stability of minerals.
- Geochemically modeled the effect of hazardous waste streams in deep injection wells on porosity development, mineral stability, and the integrity of the confining shales.
- Modeled the transport and fate of dissolved aqueous constituents, including radionuclides and organics, from point source discharges into ground waters and brines.
- Developed and implemented a test plan for Transportation Acceptance Criteria (TAC) to evaluate the gas generation potential of mixed-hazardous waste drums and boxes during shipment to the WIPP site.
- Evaluated analytical data and interacted with contract laboratories on modifications and/or substitution of analytical techniques to obtain accurate data on samples with unusual matrices.
- Estimated decomposition products and gas generation potential from the breakdown of mixed-hazardous waste due to radiolytic, bacterial, chemical, and oxidation processes.

- Manager of multiple projects concerned with various aspects of collection, interpretation, and integration of geochemical data and modeling results into deliverables.

1985 -
1986

Research Specialist Geochemist, Reservoir and Facies Division, Exxon Production Research Company, Houston, Texas. Coordinated multidivision effort to evaluate the importance of organic acids in diagenesis of clastic sediments, including the design of hydrolysis and hydrothermal solubility experiments.

- Incorporated metal-organic acid complexes into thermodynamic chemical equilibrium program (EQ3/6) to improve oil reservoir quality and secondary porosity prediction. Demonstrated that metal-organic complexes destabilize secondary clay development. First application to clastic diagenesis.
- Detected unusual surface geochemistry and alteration mineralogy patterns from brine and hydrocarbon "microseepage" above deep petroleum reservoirs. Recognition of electrically resistive silicified zones in near-surface over hydrocarbon "chimneys" due to interaction between brines and tuffaceous sediments.

1980 -
1985

Research Specialist Geochemist, Geologic Research Department, Exxon Minerals Company, Houston, Texas. Coordinated application of exploration geochemistry to minerals exploration and production. Directed laboratory and field studies for mobility and fate of metals in soils and weathering profiles. Geochemical modeling of weathering processes, including prediction of precipitation barriers. Applied soil gas chemistry for detecting buried mineral deposits and oil and gas. Utilized remote sensing techniques to detect buried mineralization. Managed four analytical laboratories.

- Developed partial leaching techniques for soils and stream sediments to determine trace element speciation between different mineral phases and amorphous coatings, including organics.
- Delineated subsurface oil and mineral deposits utilizing instantaneous and integrative soil gas sampling techniques. Soil gases measured during field studies included: O₂, N₂, CO₂, CO, SO₂, H₂S, CH₄, C₂H₆, CS₂, and Hg.
- Demonstrated upward mobility of metals through thick (30+ m) layers of lateritic and/or transported soils.
- Developed three geochemical field kits, one of which detected fine-grained alunite in silicified outcrops to help rank gold prospects.
- Supervised and directed ten technicians at four analytical laboratories in preparing and analyzing geologic, aqueous and botanical samples.

Laboratories provided analytical support for professional research and technical service projects.

- Detected "stress" in plants by high-resolution infrared remote sensing. Used to delineate anomalous concentrations of toxic metals in soils. Mapped alteration mineralogy in outcrop utilizing high-resolution and satellite imagery.
- Developed seven rock standards for quality control of in-house and outside analytical laboratories. Conducted quality control survey of 15 analytical laboratories.

1977 -
1980

Research Geochemist, Minerals Exploration Research, Exxon Production Research Company, Houston, Texas. Responsible for three analytical laboratories. Coordinated studies of sandstone uranium deposits, including activities of managing consultants.

- Studied uranium solution geochemistry in vicinity of sandstone uranium deposits, including the influence of clays and iron oxides on adsorption of uranium.
- Developed differential leaching techniques for discrimination of uranium speciation in clastic sediments and rocks.
- Developed methods for atomic absorption and plasma spectroscopy analysis of mineral separates, ores, soils, leachates, and brines.
- Managed sandstone uranium drilling program for recovery of core and drill cuttings for geochemistry and mineralogy.
- Investigated dolomization of limestone by using trace elements and stable isotopes.

Professional Affiliations

Association of Exploration Geochemists
Geochemical Society
International Association of Geochemistry and Cosmochemistry



Publications

Drez, P., Chakraborti, S., Bretzke D., McCann, J., Edson, C., Harvill, J., Lott, S., Teak, J., Bisping, R., Zimmerman, M., Krieger, E., Roy, L., Adams, R., Kramer, E., 1996, "The Challenge of Building a Transuranic Waste Inventory for Waste Isolation Pilot Plant Regulatory Compliance Modeling/Application," abstract submitted to Waste Management 1997 conference, Tucson, Arizona.

Chakraborti, S., Abashian, M., Drez, P., Burrington, T., Lopez, J., and R. Batra, 1992, "Review of Alternative Container Materials for TRU Waste: An Expert Panel Evaluation," paper presented at The 1992 Incineration Conference, Albuquerque, New Mexico.

Myers, J., P. James, and P. Drez, in preparation, "The Redox State of the Culebra Member of the Rustler Formation," in "Hydrogeochemical Studies of the Rustler Formation and Related Rocks in the WIPP Area, Southeastern New Mexico," SAND88-0196, M. D. Siegal, S. J. Lambert, and K. L. Robinson, editors, Sandia National Laboratories, Albuquerque, New Mexico.

Drez, P. E., Devarakonda, M., and J. Cruse, 1991, "Summary and Status of TRU Waste Characterization," paper presented at *Waste Management '91, Proceedings of the Symposium in Waste Management*, Tucson, Arizona.

Johnson, J., Davis, H., Drez, P. E., Devarakonda, M., 1991, "Pretest Characterization of Waste Isolation Pilot Plant (WIPP) Experimental Waste," paper presented at *Waste Management '91, Proceedings of the Symposium in Waste Management*, Tucson, Arizona.

Myers, J., Djordjevic, S. M., Adams, M., Spangler, R., Valdez, J., Vetter, D., and P. E. Drez, 1991, "Design Analysis of Engineered Alternatives for the Waste Isolation Pilot Plant," paper presented at *Waste Management '91, Proceedings of the Symposium in Waste Management*, Tucson, Arizona.

Abitz, R. J., J. Myers, P. E. Drez, and D. E. Deal, 1990, "Geochemistry of Salado Formation Brines Recovered from the Waste Isolation Pilot Plant (WIPP) Repository," paper presented at *Waste Management '90, Proceedings of the Symposium in Waste Management*, Tucson, Arizona.

Drez, P. E., S. Djordjevic, D. V. S. Murthy, G. Quinn, and C. Temus, 1990, "Aspiration Requirements for the Transportation of Retrievable Stored Waste in the TRUPACT-II Shipping Package," *Waste Management '90, Proceedings of the Symposium on Waste Management*, Tucson, Arizona.

Murthy, D. V. S., and P. E. Drez, 1990, "Transportation of Transuranic Waste to the Waste Isolation Pilot Plant - An Overview," presented at the Summer National AIChE Meeting, San Diego, California.

Deal, D. E., Abitz, R. J., Belski, D. S., Case, J. B., Crawley, M. E., Deshler, R. M., Drez, P. E., Givens, C. A., King, R. B., Lauctes, B. A., Myers, J., Niou, S., Pietz, J. M., Roggenthen, W. M., Tyburski, J. R., and M. G. Wallace, 1989, "Brine Sampling



and Evaluation Program 1988 Report," *DOE-WIPP-89-015*, U.S. Department of Energy.

Drez, P. E., D. V. S. Murthy, C. J. Temus, G. J. Quinn, and C. B. Ozaki, 1989, "Influence of Nonradioactive Parameters on Radioactive Shipping Packages," (abstract) *PATRAM '89*, Washington, D.C.

Drez, P. E., 1988, "Rock-Water Interactions Between Injected Waste and Host Rock Formation Fluids and Mineralogy During Deep Well Injection," (abstract) *Proceedings of the American Geophysical Union*, 1988 Spring Meeting.

Deal, D. E., J. B. Case, R. M. Deshler, P. E. Drez, J. Myers, and J. R. Tyburski, 1987, "Brine Sampling and Evaluation Program Phase II Report," *DOE-WIPP-87-010*, Carlsbad, New Mexico.

Drez, P. E., R. K. Warren, and W. J. Harrison, 1987, "Possible Silicification and Surface Microlayer Anomalies Due to Microseepage of Brines Associated with Hydrocarbons," abstract, American Association of Petroleum Geologists Research Conference, Prediction of Reservoir Quality Through Chemical Modeling (invited paper).

Drez, P. E., and W. J. Harrison, 1987, "Do Organic Acids Have a Role in Clastic Diagenesis?" abstract, American Association of Petroleum Geologists Research Conference, Prediction of Reservoir Quality Through Chemical Modeling (invited paper).

Drez, P. E., 1985, "The Use of Soil Gases for the Detection of Sulfides Beneath Transported Overburden," Exxon Minerals Company Exploration Memo, 28 pp.

Bence, A. E., and P. E. Drez, 1985, "Stratiform Massive Sulfide Deposits: Strontium Isotopic Composition of Bedded Barites," Exxon Minerals Company Exploration Memo, 28 pp.

Smith, D. P., P. E. Drez, and H. H. Sandling, 1985, "The Use of a Personal Computer for On-Line Simultaneous Determination of Water, Carbon, and Sulfur by Infrared Absorption Spectroscopy," abstract, 189th American Chemical Society National Meeting, Miami Beach, Florida.

Drez, P. E., 1985, "Enhancement of Anomalies Distal to Cu-Au Porphyry Systems in Papua New Guinea - Case Histories," abstract, 11th International Geochemical Exploration Symposium, Toronto, Ontario, Canada.

Baum, G. R., W. B. Harris, and P. E. Drez, 1985, "Origin of Dolomite in the Eocene Castle Hayne Limestone, North Carolina," *Journal of Sedimentary Petrology*, Vol. 55, No. 4, pp. 506-517.

Baum, G. R., W. B. Harris, and P. E. Drez, 1985, "Sodium Distribution in Eocene Dolomites from the Castle Hayne Limestone, North Carolina," abstract, American Association of Petrological Geologists Annual Meeting, New Orleans.

Drez, P. E., 1983, "Alunite Chemical Field Test Addendum: Discrimination of Alunite in the Presence of Jarosite," Exxon Minerals Company Exploration Memo, 6 pp.

Drez, P. E., 1983, "Mobility of Metals in the Papua New Guinea Weathering Environment: Implications for Exploration," Exxon Minerals Company Exploration Memo, 205 pp.

Drez, P. E., 1983, "Alunite Chemical Field Test," Exxon Minerals Company Exploration Memo, 12 pp.

Drez, P. E., 1982, "Detection of a Surface Geochemical Anomaly Above the Scuddles Prospect: A Preliminary Report," Exxon Minerals Company Exploration Memo, 8 pp.

Drez, P. E., 1981, "Olivinae (Mollusca:Gastropoda) from the Alum Bluff Group of Northwestern Florida," *Tulane Studies in Geology and Paleontology*, Vol. 16, pp. 105-122.

Drez, P. E., S. S. Sedeora, and M. E. Kiibler, 1979, "Evaluation of a Dithionite Leaching Method for Extraction of Hematite and Goethite From a Sandstone Matrix," Exxon Production Research Company Exploration Memo, 17 pp.

Kidwell, A. L., and P. E. Drez, 1978, "Mineralogical Study of Bullfrog Uranium Deposit, Gardfield County, Utah," Exxon Production Research Company Technical Research Report, 22 pp.

Drez, P. E., and P. C. Ragland, 1978, "Wall-Rock Alteration Associated with Mesozoic Diabase Dikes, Durham Basin, North Carolina," Geological Society Annual Meeting, Southeastern Section, Vol. 10, No. 4, pp. 161-162.

Baum, G. R., W. B. Harris, and P. E. Drez, 1978, "Dolomitization of the Middle Eocene Castle Hayne Limestone, North Carolina, U.S.A.," International Association Sedimentologists, 10th International Congress, Jerusalem, Vol. 1, pp. 59-60.

Drez, P. E., 1977, "Hydrothermal Alteration of Low-K Tholeiitic Dikes and Intruded Clastic Sediments," Doctoral Dissertation, University of North Carolina, Chapel Hill, 305 pp.

Drez, P. E., 1977, "Deuteric Alteration in Mesozoic Diabase Dikes From Central North Carolina," *Geologic Society of America, Southeastern Section*, Vol. 9, No. 2, pp. 134-135.

Ragland, P. C., and P. E. Drez, 1975, "Elemental Gains and Losses During Chemical Weathering of Calc-Alkaline Plutonic Rocks," *Geologic Society of America Meeting, Southeastern Section*, Vol. 7, No. 4, pp. 525-526.

Ray, C. E., A. Wetmore, D. H. Dunkle, and P. E. Drez, 1968, "Fossil Vertebrates From the Marine Pleistocene of Southeastern Virginia," *Smithsonian Miscellaneous Collection*, Vol. 153, No. 3, 25 pp.

Curriculum Vitae

DATE: January 1997

NAME: GRANDSTAFF, David E.

EDUCATION, UNDERGRADUATE AND GRADUATE:

University of California, Santa Cruz, Santa Cruz,
California 1965-1969

B.A. Chemistry - June 1969
B.A. Geology - June 1969

Princeton University, Princeton, New Jersey 1969-1973

M.A. Geology - June 1972
Ph.D. Geology - January 1974

DOCTORAL DISSERTATION:

Kinetics of uraninite oxidation: implication for the
Precambrian atmosphere. August 1973. H. D. Holland

POSITIONS HELD:

Temple University

Instructor 1973-1974
Assistant Professor 1974-1980
Associate Professor 1981-1986
Professor 1987-present

YEAR APPOINTED AT TEMPLE AND RANK AT APPOINTMENT:

1973, Instructor

YEAR TENURED IF APPOINTED UNTENURED: 1981

YEAR PROMOTED TO ASSOCIATE PROFESSOR IF APPOINTED
BELOW THAT RANK: 1981

YEAR PROMOTED TO FULL PROFESSOR IF APPOINTED BELOW
THAT RANK: 1987

AWARDS:

Best Paper Award, Nuclear Division, American Ceramic Society. 1990.

Research Achievement Award, International Technology Corporation (IT). 1992.

Robert Ebersole Award for Research Excellence. Temple University. 1992.

PUBLICATIONS:

BOOKS PUBLISHED OR IN PRESS:

EDITED BOOKS PUBLISHED OR IN PRESS:

TEXTBOOKS PUBLISHED OR IN PRESS:

RESEARCH ARTICLES PUBLISHED OR IN PRESS:

Grandstaff D.E., 1972. Use of mercuric bromide as a heavy liquid. *Am. Mineral.*, 57, 1899-1902.

Grandstaff D.E., 1974. Microprobe analyses of uranium and thorium in uraninite from the Witwatersrand, South Africa and Blind River, Ontario, Canada. *Trans. Geol. Soc. S. Africa*, 77, 291-294.

Grandstaff D.E., 1976. A kinetic study of the dissolution of uraninite. *Econ. Geol.*, 71, 1493-1506.

Grandstaff D.E., 1977. Some kinetics of bronzite orthopyroxene dissolution. *Geochim. Cosmochim. Acta*, 41, 1097-1104.

Grandstaff D.E., 1978. Changes in surface area and morphology and the mechanism of forsterite dissolution. *Geochim. Cosmochim. Acta*, 42, 1899-1902.

Myer G.H. and Grandstaff D.E., 1979. Lead contamination of urban snow. *Arch. Env'tl. Health*, 34, 222-223.

Gay A.L., and Grandstaff D.E., 1980. Chemistry and Mineralogy of Precambrian paleosols at Elliot Lake, Ontario, Canada. *Precambrian Res.*, 12, 349-373.

Grandstaff D.E., 1980. Origin of uraniferous conglomerates at Elliot Lake, Canada and Witwatersrand, South Africa: Implications for oxygen in the Precambrian atmosphere.



Precambrian Res., 13, 1-26.

Grandstaff D.E., 1980. The dissolution rate of forsteritic olivine from Hawaiian beach sand. In: Third International Symposium on Water-Rock Interactions, Brian Hitchon (ed.), 72-74, Alberta-Research Council.

Grandstaff D.E., 1981. Uraninite oxidation and the Precambrian atmosphere. In: Genesis of Uranium- and Gold-Bearing Precambrian Quartz-Pebble Conglomerates, F.C. Armstrong (ed.), Chapter C1-C17, United States Geological Survey Professional Paper 1161.

Grandstaff D.E., 1981. Microprobe analyses of uranium and thorium in uraninite from the Witwatersrand, South Africa and Blind River, Ontario, Canada. In Genesis of Uranium- and Gold-Bearing Precambrian Quartz-Pebble Conglomerates, F.C. Armstrong (ed.), Chapter J1-J5, United States Geological Survey Professional Paper 1161.

Elliot W.C., Grandstaff D.E., Ulmer G.C., Buntin T., and Gold D.P., 1982. An intrinsic oxygen fugacity study of platinum-carbon associations in layered intrusions. Econ. Geol., 77, 1493-1510.

Bourcier W.L., McKibben M.A., Barnes H.L., Ulmer G.C., Brozdowski R., and Grandstaff D.E., 1983. Hydrothermal pH and H₂ measurements using the zirconia electrode and teflon membrane. In: Fourth International Symposium on Water-Rock Interactions, H. Sakai (ed.), 59-61.

Moore E.L., Ulmer G.C., and Grandstaff D.E., 1983. Hydrothermal alteration in the system basalt/groundwater. In: Fourth International Symposium on Water-Rock Interactions, H. Sakai (ed.), 356-359.

Ulmer G.C., Grandstaff D.E., Brozdowski R., Bourcier W.L., McKibben M., and Barnes H.L., 1983. An overview progress report: Eh-pH monitoring at elevated temperature and pressure. Fourth International Symposium on Water-Rock Interactions, H. Sakai (ed.), 519-521.

Grandstaff D.E., McKeon G.L., Moore E.L., and Ulmer G.C., 1984. Reactions in the system basalt/simulated spent fuel/water. In: The Scientific Basis for Nuclear Waste Management, Vol. 26, pp 137-145, Elsevier.

Kimberley M.M., Grandstaff D.E., and Tanaka R.T., 1984. Topographic control on Precambrian weathering in the Elliot Lake uranium district, Canada. Geol. Soc. London.

Myers J., Ulmer G.C., Grandstaff D.E., Danielson M.J., and Koski O.H., 1984. Developments in the monitoring and control of Eh and pH conditions in hydrothermal experiments. In: *Geochemical Behavior of Disposed Radioactive Waste*, G.S. Barney, J.D. Navratil, and W.W. Schulz (eds.). American Chem. Soc, Washington, D.C.

Retallack G.J., Grandstaff D.E., and Kimberley M.M., 1984. The promise and problems of Precambrian paleosols. *Episodes*, 7, 8-12.

Buntin T.J., Grandstaff D.E., Ulmer G.C., and Gold D.P., 1985. A pilot study of geochemical and redox relationships between potholes and adjacent normal Merensky Reef in the Bushveld Complex. *Econ. Geol.*, 50, 173-185.

Moore E.L., Ulmer G.C., and Grandstaff D.E., 1985. Hydrothermal interaction of Columbia Plateau basalt from the Umtanum Flow (Washington, U.S.A.) with its coexisting groundwater. *Chem. Geol.*, 49, 53-71.

Grandstaff, D.E., 1986. The dissolution rate of forsteritic olivine from Hawaiian beach sand. In *Rock and Mineral Weathering*, edited by S. Coleman and D. Dethier. New York: Academic Press.

Grandstaff D.E., Edelman M.J., Foster R.W., Zbinden E., and Kimberley M.M., 1986. Chemistry and mineralogy of Precambrian paleosols at the base of the Dominion and Pongola Groups (Transvaal, South Africa). *Precambrian Research*, 32, 97-131.

Kacandes G.H., Ulmer G.C., and Grandstaff D.E., 1986. Icelandic geothermal fields as an analog for nuclear waste isolation in Columbia Plateau (Washington) basalt. In: *Fifth International Symposium on Water-Rock Interactions*. Reykjavik, Iceland, pp. 302-305.

Korn R., Ulmer G.C., and Grandstaff D.E., 1986. Hydrothermal reactions of Columbia Plateau basalts from the Umtanum and Cohasset flows (Washington) with simulated Hanford Groundwaters. In: *Fifth International Symposium on Water-Rock Interactions*. Reykjavik, Iceland, pp 333-336.

Ulmer. G.C., Grandstaff D.E., Weiss D., Moats M.A., Buntin T.J., Gold D.P., Hatton C.J., Kadik A., Koseluk R., Rosenhauer M., 1987. The mantle redox state; An unfinished story? *Geol. Soc. Special Paper* 215, p. 5-23.

Ulmer. G.C., Kacandes G.H., and Grandstaff D.E., 1987. Icelandic geothermal fields as an analog for nuclear waste

Name: Grandstaff, David E.

Page 5

isolation in basalt. Nuclear Waste Management II, Advances in Ceramics, 20, D. E. Clark (ed.), 421-428.

Gardiner M.A., Kacandes G.H., Ulmer G.C., and Grandstaff D.E., 1988. Application and results of a re-injection technique for hydrothermal experiments in Dickson autoclaves. In: Scientific Basis for Nuclear Waste Management, M. Apter and R. Westerman (eds.), Elsevier, pp. 383-392.

Lazaar P.I., Ulmer G.C., and Grandstaff D.E., 1988. A study of the hydrothermal stability of copper for use as a canister material for nuclear waste. In: Scientific Basis for Nuclear Waste Management, M.A. Apter and R. Westerman (eds.), Elsevier, pp. 805-813.

Kacandes G.H. and Grandstaff D. E., 1989. Differences between geothermal and experimentally derived fluids: how well do hydrothermal experiments model the composition of geothermal reservoir fluids. Geochim. Cosmochim. Acta 52, 343-358.

Gardiner M.A., Ulmer G.C., and Grandstaff D.E., 1989. Application of a reinjection technique to Dickson hydrothermal experiments: The effect of introducing fresh solution to the basalt-water system at 300°C and 300 bars. In: Water-Rock Interactions, WRI-6, (D. L. Miles [ed.]), 239-242, A. A. Balkema, Rotterdam.
(received best paper award: International Technology Corporation)

Kacandes G.H., Ulmer G.C. and Grandstaff D.E., 1989. Variations in fluid chemistry and alteration mineral paragenesis during basalt/hot water interactions. In: Water-Rock Interactions, WRI-6 (D. L. Miles (ed)), 353-356., A. A. Balkema, Rotterdam.

Wang J., Gardiner M., Grandstaff D.E., and Ulmer G.C., 1989. The geothermal oxidation of basalt. In: Water-Rock Interactions WRI-6 (D.L. Miles (ed.)), 735-738, A. A. Balkema, Rotterdam.

Grandstaff D.E., Ulmer G.C., and Kacandes G.H., 1990. Prediction of near-field fluid composition in high-level nuclear waste repositories: Data from geothermal and experimental analogs. Nuclear Waste Management III. Am. Ceramic Society.
(received best paper award from American Ceramic Society: Nuclear Division)

Ulmer G.C., Grandstaff, D.E., and Myers J. 1990. A

hydrothermal buffer capsule technique for redox measurements. In: Fluid-Mineral Interactions: A Tribute to H. P. Eugster, R. J. Spencer and I-M. Chou, eds. Geochemical Society Special Publication #2, San Antonio, TX.

Grandstaff D.E., Grassi V.J., Lee A.C., and Ulmer G.C., 1991. Comparison of granite, tuff, and basalt as geologic media for long-term storage of high-level nuclear waste. Scientific Basis for Nuclear Waste Management XIV. (T. Abrajano, J.H. Johnson, eds.), Materials Research Society, Pittsburgh, Pa, pp. 849-854.

Grassi, V.J., Ulmer G.C., and Grandstaff D.E., 1992. The effect of igneous rock type on nuclear waste siting. Nuclear Waste Management IV. American Ceramic Society, pp. 695-706.

Grassi, V.J., Ulmer G.C., and Grandstaff D.E., 1992. Water-rock hydrothermal experiments: Influence of rock type on solution pH and oxygen fugacity. Water-Rock Interactions Symposium 7, Y. Kharaka (ed).

Cheng, Y., Lee A.C., Grassi V.J., Grandstaff D.E., and Ulmer G.C., 1992. An autoclave reinjection study of a vitreous rhyolite tuff. Water-Rock Interactions Symposium 7, Y. Kharaka (ed).

DeMaio, T., and Grandstaff, D. E. (1995). The effects of dilute organic acids on calcite dissolution. In: Water-Rock Interaction Symposium 8, (Y. K. Kharaka and F. Chudaev, eds.), p 241-245, Balkema, Rotterdam.

Jones T. P. and Grandstaff, D. E. (1995). Controls on dissolved aluminum in the New Jersey Pine Barrens, In: Water-Rock Interaction 8, (Y. K. Kharaka, F. Chudaev, eds.), p. 351-355, Balkema, Rotterdam.

Teng, H. and Grandstaff, D. E., (1996). The effect of pH and organic acids on dissolution of basaltic glass. In, The Scientific Basis for Nuclear Waste Management. Materials Research Society, Pittsburgh, PA.

DeMaio, T. and Grandstaff, D. E. (in press). The effects of dilute organic acids on calcite dissolution. In, The Scientific Basis for Nuclear Waste Management. Materials Research Society, Pittsburgh, PA.

Ulmer, G. C., Grandstaff D. E., Woermann E., Gobbels M., Schonitz M., and Woodland A., (in preparation). Metastability of SiC (Moissanite) Relative to Paragenetic Associations in Kimberlites and Meteorites.

OTHER WORKS PUBLISHED OR IN PRESS:

ABSTRACTS:

Grandstaff D.E., 1974. Uraninite oxidation and the Precambrian atmosphere. Trans. Am. Geophys. Union, 55, 457.

Grandstaff D.E., 1975. Some kinetics of bronzite orthopyroxene dissolution. Trans. Am. Geophys. Union, 56, 459.

Grandstaff D.E., 1977. Some kinetics of forsterite olivine dissolution. Trans. Am. Geophys. Union, 58, 458.

Myer G.H., DeSantis J., Grandstaff, D.E., and Grandstaff, B.E., 1977. A multistage model of preservation in some fossil plants. Geol. Soc. Am. Abstracts with Prog. Northeast Section, 9, 304.

Sleight M.C., and Grandstaff, D.E., 1978. Aluminum concentrations in the Mullica River-Great Bay estuary. Trans. Am. Geophys. Union, 59, 290.

Gay A.L., and Grandstaff D.E., 1979. Precambrian paleosols at Elliot Lake, Ontario. Geol. Assoc. Canada. Abstracts with Prog., 4, 52.

Grandstaff D.E., Kinetics of olivine dissolution II. Effect of organic chelating ligands. Trans. Am. Geophys. Union, 60, V-170.

Gallagher M.N., Grandstaff D.E., and Adams J.K., 1980. Hydrology and geochemistry of central Bucks County, Southeastern Pennsylvania. Geol. Soc. Am. Abstracts with Programs. Northeast Section, 12, 37.

Schulz E.B., and Grandstaff D.E., 1980. Trace element concentrations in *Mercenaria mercenaria* from Great Bay, New Jersey. Geol. Soc. Am. Abstracts with Programs, Northeastern Section, 12, 81.

Moore E.L., Ulmer G.C., and Grandstaff D.E., 1981. Interaction of basalt and continental groundwater at 200°C and 300°C. Trans. Am. Geophys. Union, 63, 450.

Ulmer G.C., Elliot W.C., Grandstaff D.E., and Gold D.P., 1981. Petrogenesis of the platiniferous zone of the Stillwater Complex, Montana. CSIR Platinum Conference,

Pretoria, R.S.A.

Kimberley M.M., Grandstaff D.E., and Tanaka R.T., 1982. Topographic control on Precambrian weathering in the Elliot Lake uranium district, Canada. Internatl. Geol. Correl. Prog. 157 Conference, London, England.

McKeon G.L., Ulmer G.C., and Grandstaff D.E., 1982. Stability of spent fuel in a nuclear waste repository located in basalt. Trans. Am. Geophys. Union, 64, V100.

Ulmer G.C., Grandstaff D.E., Brozdowski R.A., Barnes H.L., and Bourcier W.L., 1982. New developments in hydrothermal Eh-pH measurements. Geol. Soc. Am. Abstracts with Programs.

Buntin T.J., Grandstaff D.E., Ulmer G.C. and Gold D.P., 1983. A pilot study of geochemical and redox relationships between potholes and adjacent normal Merensky Reef of the Bushveld Igneous Complex. Geol. Soc. Am. Abstracts with Programs.

Clark L.D., Kimberley M.M., Grandstaff D.E. and Edelman M.J., 1983. Precambrian weathering horizons: Subproject 1 of IGCP 157. Geol. Soc. Am. Abstracts with Programs, 15, 545.

Edelman M.J., Grandstaff D. E., and Kimberley M.M., 1983. Description and implications of two early Precambrian paleoweathering profiles from South Africa. Geol. Soc. Am. Abstracts with Programs., 15, 565.

Grandstaff D.E., McKeon G.L., Moore E.L., and Ulmer G.C., 1983. Reactions in the system basalt-simulated spent fuel-water. Materials Res. Soc. Prog. D2.8, 189.

Ulmer G.C., Grandstaff D.E., and Brozdowski R.A., 1983. Geologic applications of ZrO₂ electrolytic cells. Second International Conference on the Science and Technology of Zirconia, Stuttgart, FRG, Max-Plank Inst. fur Metallforschung, D6.

Ulmer G.C., Grandstaff D.E., Brozdowski R.A., Barnes H.L. and Bourcier W.L., 1983. New developments in hydrothermal Eh-pH measurements. Geol. Soc. Am. Abstracts with Prog.

Grandstaff D.E., Foster R.W., Korn R.A., and Ulmer G.C., 1985. Measurement of hydrothermal redox using a direct hydrogen evolution method (DHEM). Second International Symposium on Hydrothermal Reactions, Pennsylvania State University, pg. 10.

Grandstaff D.E., Ulmer G.C., Myers J., and McKeon G.L.,

Name: Grandstaff, David E.

Page 9

1985. A hydrothermal buffer capsule technique for redox measurements. Am. Geophys. Union.

Ulmer G.C., Korn R.A., Foster R.W., and Grandstaff D.E., 1985. Measurement of hydrothermal redox using DHEM: Implications for nuclear waste disposal. Second International Symposium on Hydrothermal Reactions. Pennsylvania State University, Abstracts with Prog., p. 29.

Friel J.J., Kacandes G.H., Grandstaff D.E. and Ulmer G.C., 1986. Image analysis of an Icelandic basalt. Geol. Soc. America, Abstr. with Prog.

Grandstaff D.E., 1986. Precambrian paleosols and the composition of the mid-Precambrian atmosphere. Trans. Am. Geophys. Union, 67.

Kacandes G.H., Ulmer G.C., and Grandstaff D.E., 1986. Importance of intersertal glass for an Icelandic analog for nuclear waste isolation in Columbia Plateau basalt. Trans. Am. Geophys. Union, 67, 250.

Ulmer G.C., Kacandes G.H., and Grandstaff D.E., 1986. Icelandic geothermal fields as an analog for nuclear waste isolation in basalt. Amer. Ceram. Soc., Abstr. with Prog.

Gardiner M.A., Kacandes G.H., Ulmer G.C., and Grandstaff D.E., 1987. Use of re-injection techniques for hydrothermal experiments in Dickson autoclaves. Am. Geophys. Union, 68.

Grandstaff D.E., Ulmer G.C., Kacandes G.H., and Gardiner M., 1987. Results of basalt-water experiments: Implications for nuclear waste disposal. Mater. Res. Soc., Abstr. with Prog.

Kacandes G.H., Ulmer G.C., and Grandstaff D.E., 1987. pH differences between experimentally derived and natural hydrothermal fluids: possible role of CO₂. Trans. Am. Geophys. Union.

Lazaar P.I., Ulmer G.C., and Grandstaff D.E., 1987. A study of the hydrothermal stability of copper for use as a canister material for nuclear waste. Materials Research Society, Boston, MA.

Kacandes G.H., Ulmer G.C., Grandstaff D.E., 1988. How well do water-rock experiments model the composition of geothermal reservoir fluids? Mineral Exploration Research Institute, Symposium on Experimental Investigations of Hydrothermal Processes, Montreal, PQ.

Wang J., Ulmer G.C., Grandstaff D.E., and Friel J.J., 1988.

Basaltic residium glasses: an old and a new problem. Goldschmidt Conference, p. 9.

Kacandes G. H. and Grandstaff D. E., 1988. Alteration mineral paragenesis and variations in fluid chemistry during basalt/hot water interactions. American Geophysical Union.

Grandstaff D.E., Ulmer G.C. and Kacandes G.H., 1989. Prediction of near-field fluid composition in high-level nuclear waste repositories: limits of analogs - limits of experiments. Am. Ceramic Society Abstracts, p. 108.

Wang J., Ulmer. G.C., and Grandstaff D.E., 1989. The geothermal oxidation of basalt. International Geological Congress. Washington, D.C.

Anton J.A., Grandstaff B.S., and Grandstaff D.E., 1990. Modes of staining in fossil shark teeth (Abstract). Journal of Vertebrate Paleontology, 10, 12A-13A.

Ulmer G.C., Grandstaff D.E., Hanson B., Gold D.P., and Deines P. 1990. Texture, and ¹³C Data for graphite in mafic igneous plutons (abstract). American Geophysical Union, 71, 661.

Lee A.C., Grandstaff D.E., and Ulmer G.C., 1990. The effect of rhyolitic glass on solution parameters in autoclave experiments at 300C and 30 MPa (abstract). The American Geophysical Union, 71, 663.

Ulmer G.C. Grassi V.J., Lee A. and Grandstaff D.E., 1990. Comparison of tuff, granite, and basalt as high-level repository host rocks: lithologic factors influencing fluid compositions (abstract). Materials Research Society.

Grassi V.J., Ulmer G.C., and Grandstaff D.E., 1991. Hydrothermal experiments using tuff, granite, and basalt: Implications for high-level nuclear waste repositories (abstract), American Ceramic Society Annual Meeting, Cincinnati, OH.

Bowen, B. and Grandstaff D.E., 1992. R-Mode factor analysis of variations in chemical composition of river water during storm events (abstract). Trans. Amer. Geophys. Union (EOS), 73, 113.

Grandstaff, D.E., and Ulmer G.C., 1992. Fluid inclusions in diamond, equations of state, and mantle redox conditions (abstract). Trans. Amer. Geophys. Union (EOS), 73, 335.

Sirkis, D., Ulmer G., Grandstaff D., Castro J., and Gold D.,

Name: Grandstaff, David E.

Page 11

1992. Testing a model of diatreme emplacement at Oka, Quebec, using rock magnetism (abstract). Trans. Amer. Geophys. Union (EOS), 73, 103.

Yan, C., and Grandstaff D.E., 1992. Concentrations and transport mechanisms of Cd, Pb, and Zn in roadside soils affected by automotive pollution (abstract). Trans. Amer. Geophys. Union (EOS), 73, 62.

Grassi V. J., Myer G. H., Ulmer G. C., and Grandstaff D. E., 1993. Ferrierite formation during a hydrothermal reinjection experiment (abstract). Trans. Amer. Geophys. Union (EOS), 74, 161.

Ulmer G. C., Grandstaff D. E., and Woermann E., 1993. Moissonite Stability: A mantle redox problem? (abstract). Terra nova, 5, 511.

Ulmer G. C., Grandstaff D. E., and Woermann E., 1993. Mantle redox: an overview of the uncertainties (abstract). Terra nova, 5, 512.

DeMaio T., and Grandstaff D. E., 1994. The influence of dilute organic acids on the rate of calcite dissolution. Trans. Amer. Geophys. Union (EOS), 75, 139.

Freiheiter M. and Grandstaff D. E., 1994. Conservative versus non-conservative behavior of selected species in the estuary of the Great Egg Harbor River, New Jersey. Geol. Soc. Am., Abstracts with Programs, Northeast Section.

Jones T. P., and Grandstaff D. E., 1994. Geochemical controls on aluminum, iron, and other species in surface waters of the New Jersey Pine Barrens. Trans. Amer. Geophys. Union (EOS), 75, 136.

Teng H., and Grandstaff D. E., 1994. The dissolution of volcanic glass: the effect of pH and organic acids. Trans. Amer. Geophys. Union (EOS), 75, 140.

Woodward B. J., and Grandstaff D. E., 1994. Variations in stream water chemistry during storm events near the brookdale mine, Phoenixville, Pennsylvania. Trans. Amer. Geophys. Union (EOS), 75, 177.

Jones T. P., and Grandstaff D. E., 1995. Hydrochemistry of selected species in surface waters of the New Jersey Pine Barrens (abstract). Geol. Soc. America, Abstracts with Programs, Northeast Section.

Ulmer, G. C., Grandstaff, D. E., Woermann, E., and Schönitz,

M., (1995). Metastability of SiC (Moissanite) Relative to Paragenetic Associations in Kimberlites and Meteorites. Goldschmidt Conference, Pennsylvania State University.

Ulmer, G. C., Grandstaff, D. E., Woermann, E., and Schönitz, M. (1995). Equilibrium stability of SiC (Moissanite). Goldschmidt Conference, Pennsylvania State University.

Teng, H., and Grandstaff, D. E., (1995). The effect of pH and organic acids on dissolution of basaltic glass. Materials Research Society, Abstracts with Programs, Boston, MA.

DeMaio, T. and Grandstaff, D. E. (1996). The effect of dilute organic acids on calcite dissolution. Materials Research Society, Abstracts with Programs, Boston, MA.

Betts, J. and Grandstaff, D. E. (1997). Geochemical variations with depth in vadose zone fluids in the glauconite-rich Hornerstown Formation, New Jersey. (abstract). Abstracts with Programs, Geol. Soc. Am. Northeast Section.

Harvey, A. and Grandstaff, D. E. (1997). Environmental reconstruction in the Duncannon Member, Catskill Formation (Devonian). Abstracts with Programs, Geol. Soc. Am. Northeast Section.

Mandal, M. and Grandstaff, D. E. (1977). Geochemistry of throughfall in Wharton State Forest, New Jersey. Abstracts with Programs, Geol. Soc. Am. Northeast Section.

Name: Grandstaff, David E.

Page 13

PUBLISHED RESEARCH REPORTS:

Moore E.L., Ulmer G.C. and Grandstaff D.E., 1981. Hydrothermal reactions in the system basalt-groundwater. Rockwell Hanford Document, U.S. DOE.

McKeon G.L., Ulmer G.C., and Grandstaff D.E., 1982. Hydrothermal reactions in the system spent fuel/groundwater/basalt. Rockwell Hanford Document No SD-BWI-BP-004, 18 p. U.S. DOE.

Grandstaff D.E., McKeon G.L., Moore E.L., and Ulmer G.C., 1983. Reactions in the system basalt-simulated spent fuel-water. Rockwell Hanford Doc. No. RHO-BW-SA-317P. U.S. DOE.

Moore E.L. Ulmer G.C., and Grandstaff D.E., 1984. Hydrothermal interaction of Columbia Plateau basalt from the Umtanum Flow with its co-existing groundwater. Rockwell Hanford Document No. SD-BWI-BP-003, 26 p. DOE.

Myers J., Ulmer G.C., Grandstaff D.E., Brozdowski R., Danielson M.J., and Koski O.H., 1984. Techniques for monitoring Eh-pH conditions in hydrothermal experiments. Rockwell Hanford Document RHO-BW-ST-049P, 39 p. U.S. DOE.

Grandstaff D.E. and Ulmer G.C., 1985. Buffering capacity and redox control in water-rock systems. Rockwell-Hanford Document SD-BWI-TI-298. U.S. DOE.

MASTER'S THESES SUPERVISED:

Sleight, Mary C. Aluminum concentrations in the Mullica River-Great Bay estuary, New Jersey. December 1978.

Palopoli, John. Lead concentrations in Tinicum Marsh, Pennsylvania. 1979.

Gay, Alison L. The study of two Precambrian paleosols and implications for the Precambrian environment and atmosphere. 1979.

Moore, Elizabeth L. Hydrothermal interaction of Columbia River Basalt from the Umtanum Formation with its co-existing groundwater. 1983.

Name: Grandstaff, David E.

Page 14

McKeon, Gail L. Hydrothermal reation of simulated spent fuel with Columbia Plateau basalt from the Umtanum Flow at 100°, 200°, and 300°C and at 30 MPa (300 bars). July 1984.

Edelman Michael J. Description and implicatons of the chemistry and mineralogy of three early Precambrian paleoweathering profiles from South Africa. 1985.

Korn, Rosemary A. A comparison of the hydrothermal stability of the Columbia Plateau basalts from the Umtanum and Cohasset flows at 100°, 200°, and 300°C; and at 30 MPa. 1986.

Gardiner, Mark A. Hydrothermal reaction of groundwater with basalt from the entablature of the Cohasset Flow, Grande Ronde Formation, Hanford, Washington: The effect of the introduction of fresh solution to the system at 200° and 300°C and 30 MPa. April 1988.

Lazaar, Paul I. A study of the hydrothermal stability of copper as a container material for a nuclear waste repository. June 1988

Foster Ruth W. Discription of early Precambrian paleosols, implications for the Precambrian atmosphere. 1988.

Kacandes, George H., How well do water-rock experiments model the composition of geothermal reservoir fluids?, 1989.

Tashjian, Paul, The sedimentology and stratigraphy of a fossiliferous layer in the Upper Cretaceous (Campanian) Englishtown/Marshalltown Formations near Ellisdale, NJ., July 1990.

Lee, Arthur C., Hydrothermal Experiments on Bannock Tuff (Montana) and Conway Granite (Vermont): Implications for nuclear waste disposal, August 1990.

Anton, John, Modes of staining in fossil sharks teeth from Big Brook, New Jersey. (August 1991).

Grassi, Vincent. Hydrothermal experiments on Topopah Springs Tuff. Implications for nuclear waste disposal (January 1993).

Kaown, D. The effect of quartz and clay minerals on retardation of ammonium in groundwater (December 1993).

DeMaio, Theresa. Calcite Dissolution Kinetics: Effect of Organic Ligands (May 1994).



Name: Grandstaff, David E.

Page 15

Freiheiter M. Conservative versus Non-conservative behavior of selected species in the estuary of the Great Egg Harbor River, New Jersey (July 1994).

Jones, T. P., Geochemical controls on aluminum, iron, and other species in the New Jersey Pine Barrens (July 1994).

Teng, H. The dissolution of basaltic glass: effects of pH and organic ligands (July 1994).

Woodward, B. J. Variations in stream water chemistry during storm events near the Brookdale Mine, Phoenixville, Pennsylvania (July 1994).

Yan, Cheng. Cadmium, Lead, Zinc, and Tin pollution along major highways (August 1994).

Bowen, Bradford. Factor analysis of changes in stream composition following storms (in progress).

Rong, W. Groundwater in the New Jersey Pine Barrens (July 1996).

Sathaye, J. Geochemistry of brines in the Illinois Basin (July 1996)

Betts, J. Vadose Zone Hydrogeochemistry in the Hornerstown Formation, New Jersey (in progress)

Harvey, A. Paleoenvironmental reconstruction in the Duncannon Member, Catskill Formation, Pennsylvania (in progress).

Mandal, M. Chemistry of throughfall in Wharton State Forest, New Jersey (in progress)

DISSERTATIONS SUPERVISED:

MASTER' AND DOCTORAL COMMITTEE SERVICE IN ADDITION TO STUDENTS YOU SUPERVISED:

M.A. Students (Committee Member):

Joseph Toth 1978

John DeSantis 1979

Mark Gallagher 1980

William Schryba 1981

Crawford Elliot 1982

Robert Brozdowski 1982

Thomas Buntin 1983

David Weiss 1985

Name: Grandstaff, David E.

Richard Sacks 1987
David Valentino 1988
Mark Moats 1989
Benjamin Hanson 1989
Linus Farius 1989
Charles Handschin, 1990
Daniel Sirkis, 1993
William Schneider, 1992
John Hill, 1992
Christian Osgood, 1995.
John Boynton, in progress
Tarja Wolf, 1996
Natalie Flynn, 1996
Takahashi Shinkawa, 1997



Ph. D. Dissertations (committee member).

Ruth W. Foster (Department of Environmental Engineering,
Rutgers University, 1994).

Michael J. Palmieri, Jr. (Department of Chemistry, Temple
University).

PROFESSIONAL MEMBERSHIPS:

Geochemical Society 1973-
International Association of Geochemists and Cosmochemists
1985-
American Geophysical Union 1973-
American Ceramic Society 1988-
Materials Research Society 1983-

performance assessment
ORIGINAL

MICHAEL B. GROSS, Ph.D.
21 Tradewind Passage
Corte Madera, CA 94925
(415) 924-5111 (Voice and Fax)
lmgross@marin.k12.ca.us

EDUCATION:

Ph.D., Mechanical Engineering, University of California, Berkeley, 1975
M.S., Physics, Harvard University, 1968
B.A., Mathematics, Johns Hopkins University, 1967



SUMMARY:

Dr. Gross is a senior engineer and computational expert with over 27 years of professional experience. This experience includes programs and studies involving geologic (rock mechanics) response, fluid mechanics and hydrology, structural response, and software development. Typical applications have included performance assessment and design of nuclear waste repositories, fluid/structure interaction for nuclear reactor safety issues, and the response of underground structures to seismic and nuclear weapons effects. The performance assessment experience includes work for the Waste Isolation Pilot Plant, for the Yucca Mountain Project and for a proposed high-level waste repository in Japan. The design experience includes development of the conceptual design for the underground facility and sealing system for a proposed high-level waste repository in salt.

From 1988 through 1993, Dr. Gross was the Deputy Manager of the Environmental Sciences & Technology Group at Science Applications International Corporation (SAIC). In this capacity, he provided management and marketing oversight for a staff of 350 people performing environmental engineering, geotechnical studies and quality assurance services. He also supervised the Group's business development activities and was the lead proposal writer for all of the Group's major bids. Prior to 1988, he was managing a division (profit center) and performing and/or managing large programs for nuclear waste repositories, for defense-related applications (hardness of deeply buried structures), and for nuclear reactor safety, particularly fluid-structure interactions.

EXPERIENCE:

January, 1995 - Present: President, Michael Gross Enterprises

Dr. Gross is an independent consultant specializing in geotechnical studies, computational studies and modeling, and project management. Recent assignments have included performance assessment of the Waste Isolation Pilot Plant (WIPP) in New Mexico, support to the development



of a nuclear waste repository in Japan, and oversight of a project in distribution automation with PG&E. For the WIPP Project, Dr. Gross is performing system-level performance calculations of the mechanical and hydrological response of the repository, with an emphasis on direct release models for cuttings/cavings, spallings and brine blowout, plus analyses of hydrological releases through the Culebra. The support for a Japanese high-level waste repository has included activities related to software quality assurance and database management for performance assessment.

December, 1993 - January, 1995: Director of Business Development, EnergyLine Systems.

Dr. Gross was managing business development activities at EnergyLine Systems, which develops and manufactures microprocessor-based controls for electric power utilities and the commercial HVAC industry. His primary focus for EnergyLine was in Asia, where he was developing real-time communications and control systems for electric power distribution in China and Southeast Asia. Through these activities he is familiar with the control and communications issues that are important for distribution automation and home automation in the evolving deregulated markets for electric power utilities.

1988 - 1993: Deputy Group Manager and Corporate Vice President, SAIC.

As Deputy Group Manager of the Environmental Services & Technology Group, Dr. Gross was instrumental in growing a business unit from \$21M to \$47M in revenue while meeting profitability goals through 1992. His responsibilities encompassed management, business development, and proposal preparation. He developed and executed strategic and annual plans for the organization and assisted in the day-to-day management of a staff of 350 engineers, scientists and their support personnel. He was also the lead proposal writer for most of the Group's major bids, achieving an average dollar win rate of 40% from 1988 through 1992.

Technical activities during this period included:

- Support to the Yucca Mountain Project. Dr. Gross worked with DOE personnel in support of the ongoing performance assessment efforts at the National Laboratories.
- Support for performance assessment activities by the PNC in Japan for development of that nation's high-level nuclear waste repository. Dr. Gross performed code surveys and participated in planning activities for an interactive, user-friendly performance assessment system.
- Key author for a Congressionally-mandated report on the U.S. Army's Chemical Demilitarization Program. Dr. Gross analyzed various chemical and biological alternatives for destruction of the U.S. stockpile of chemical weapons and wrote major sections of the report. The results and recommendations from these analyses were also presented to a Committee of the National Academy of Sciences.

1983 - 1988: Manager of Geomechanics Division and Assistant Vice President, SAIC.

As division manager, Dr. Gross was responsible for a 10-15 person staff performing computational studies in the areas of underground structural response, high-level nuclear waste repositories, and nuclear reactor safety. Major project experience during this period included:

- Task Leader for Hardness Evaluations of Deeply Buried Structures. Dr. Gross applied semi-analytical methods to evaluate the vulnerability of reinforced tunnel structures in a variety of geologic settings to the ground shock environment of a nuclear burst. Results were instrumental in reevaluating the vulnerability of the Soviet command/control system. Client was the Ballistic Missile Office, Norton Air Force Base.
- Program Manager for the Repository Seal Materials Performance Project. Dr. Gross developed and managed this integrated laboratory testing and modeling program to evaluate materials for the sealing system of a high-level nuclear waste repository in salt. Materials included clay/earthen materials, cementitious materials and crushed salt backfill. Analytic efforts included detailed design calculations for individual seals as well as a global, semi-analytical computational method. This effort involved a staff of approximately 20 full-time equivalents, two subcontractors and a budget of \$2.5 million annually. Client was the Office of Nuclear Waste Isolation.
- Task Leader for Thermomechanical Analyses for Repository Design. Dr. Gross managed a staff of 3 to 5 people performing geotechnical and geomechanical calculations in support of the conceptual design of an underground geologic repository in salt (for high-level waste). The main emphasis was on thermal, mechanical and thermomechanical calculations for design of the repository (rooms and general layout), for design of the shafts and for design of the sealing system. This three-year project involved extensive interactions with a design team covering nuclear, mechanical, electrical, mining and earth sciences disciplines. Dr. Gross was also the lead engineer for conceptual design of the repository sealing system. Client was the Department of Energy.

In addition to these major projects, Dr. Gross supervised numerous smaller projects in (i) applications of finite-element programs for structural response, and (ii) calculations of transient nonlinear events. Examples include response of structures to nearby explosions, slideplanes for three-dimensional calculations, development of a nonreflecting boundary to simulate infinite media and the thermal hydraulic analysis of nuclear reactor piping systems via the TRAC code.

1975 - 1983: Senior Scientist and Project Manager, SAIC.

Dr. Gross developed and applied finite-difference and finite-element computer programs to a wide variety of geomechanics and fluid-structure interaction problems. The geomechanical analyses have included thermal, mechanical and thermomechanical analyses of underground structures. The fluid-structure interaction analyses have involved nonlinear, large deflection structural response for nuclear reactor safety calculations and accident analyses for explosives and ordnance.

During this period, Dr. Gross was Project Manager for the Asymmetric Loads Project. In this role he developed advanced computational methods to simulate the response of the internal components of a nuclear reactor (PWR) during a Loss-of-Coolant-Accident. This project had a total budget of \$2.5 million and an average staff of 3-4 people over a four year period. Major software developments included: (i) a method to couple a one-dimensional grid to two- or three-dimensional finite-difference grids, (ii) a method to couple two-dimensional and three-dimensional finite difference programs for fluid response to the corresponding finite-element programs for structural response. These calculations produced excellent agreement with the experimental data. The client for this project was the Electric Power Research Institute.

1972 - 1975: Staff Scientist and Project Manager, Artec Associates, Inc.

Dr. Gross was a co-founder (one of three) of this small research and development company. Projects were primarily experimental in nature, including development of an explosively driven magnetohydrodynamic generator, a blast muffler system and a hypervelocity defuser for ordnance. Theoretical calculations of triple-point phenomena, as related to the Mach stem for an above ground nuclear air blast, were also performed. Clients included the Defense Nuclear Agency and the Naval Ordnance Station.

1969 - 1972: Staff Scientist and Project Manager, Physics International Company.

Dr. Gross was involved in experimental programs centered on nuclear blast wave simulation, including the phenomena of fire-ball, air blast, attenuation of air blast in a line-of-sight pipe and Mach reflection from an above ground burst. Calculations with finite-difference computer codes were also performed to assist in the design of complex gasdynamic experiments. Major client was the Defense Nuclear Agency for the nuclear simulations.

1968 - 1969: Project Engineer, Naval Ordnance Station.

Dr. Gross participated in projects to develop and improve Naval ordnance.



REFERENCES

Available upon request.

→ 206-883-0777

Rock Mechanics



Paul R. LaPointe

Education B.A., Magna Cum Laude in Geology, Amherst College, 1974.
B.A., Spanish, Amherst College, 1974.
M.S., Geology, University of Wisconsin, Madison, 1976.
Ph.D., Mining Engineering, University of Wisconsin, Madison, 1980.

Experience

1992 to date

Golder Associates

Redmond, Washington

Senior Project Manager, then Associate

Responsible for management and technical direction of reservoir engineering and characterization projects for domestic and international petroleum companies. Projects have included geological analysis, reservoir characterization and flow simulation for fractured reservoirs in Europe, Canada and the United States. Objectives of these simulations include gas deliverability, ultimate field recovery, field design and production strategies. Dr. LaPointe has served as an invited industry expert to review methodology for the U.S. Geological Survey's congressionally-mandated National Petroleum Resource Assessment. In addition, he has performed technical analyses for a variety of hazardous waste-related projects in the U.S. and abroad in which flow through rock fracture systems is a prominent concern. He is a co-teacher of workshops and short courses in fractal geometry and geostatistics for the American Association of Petroleum Geologists, the Geological Society of America, the International Society for Rock Mechanics and for private companies in the petroleum and nuclear waste industries, and has taught Golder Associates' workshops on fractured rock mass characterization and flow modeling to major integrated oil and gas companies at their facilities in North America and Europe. He has been an author or co-author of papers and monographs in reservoir geology and engineering, and session organizer and chairman for national technical society meetings in the petroleum industry.

1984 - 1992

ARCO Oil & Gas Co.

Principal Geologist

Technical Coordinator, Mathematical Geology (1988 to 1992)

Acting Research Director, Geological Interpretation Techniques (1990)

Responsible for identifying, planning, coordinating and carrying out original research and technical support in statistical, geostatistical and fractal methods. Applications include fractured reservoir analysis, resource assessment, complex pattern recognition in stochastic systems, structural modeling and Geographic Information System development to support exploration and reservoir development activities.

1982 - 1984

ARCO Oil & Gas Co.

Senior Geologist

Responsible for coordinating and planning research on flow in natural fractured systems and the development and application of geostatistical and finite element codes to problems of exploration, reservoir exploitation, and engineering.

1981 - 1982

ARCO Coal and Anaconda Minerals companies

Senior Engineer

Responsible for geotechnical investigations and numerical modeling of in-situ coal gasification processes, fragmentation analysis of coal blasting, and fugitive dust problems in coal mines.

11/92

Information Only

Paul R. LaPointe

1980 - 1981

Wisconsin Engineering Experiment Station

Associate Engineer

Responsible for carrying out field studies and numerical analyses of candidate sites for superconductive magnetic energy storage units. Devised geostatistical methods for characterizing natural rock jointing and engineering rock properties, and developed methods for incorporating spatially correlated properties in finite element models.



Robert J. Mutaw

Vita/Resume

May, 1997

Current Position:

Assistant Project Archaeologist
Woodward-Clyde Federal Services

Office Address: 4582 South Ulster Street, Suite 1200
Denver, CO
Phone: (303) 796-4617
FAX: (303) 694-3946

Education:

Doctor of Philosophy in Anthropology,
University of Colorado, 1986.

Master of Arts in Anthropology,
University of Colorado, 1982.

Bachelor of Arts in Anthropology,
Southern Illinois University, 1979.

Employment History:

1997, Assistant Project Archaeologist, Woodward-Clyde Federal Services, Denver, CO. Responsibilities include project management and technical participation in cultural resource projects, supervision of staff and subcontractors, peer review of subcontractor reports, research and authorship of EA and EIS cultural resource portions, and assisting with the preparation of proposals in response to solicitations for a variety of environmental and engineering services.

1995-1996, Senior Staff Archaeologist, Woodward-Clyde Federal Services, Denver, CO.

1992-1995, Project Director, Native Cultural Services, Boulder, CO. Responsibilities included project administration, report writing, proposal and bid preparation, laboratory analysis and curation, and fieldwork direction of survey and excavation projects; Principal Investigator for the testing of four sites in Morgan County, Colorado; co-field director for the 1993 excavations at Rock Creek Camp; research and preparation of the archaeological sections for the Central City Water Development

Project EIS; historic archaeology monitoring for the CC & V Gold Mining Company's Cresson Project.

1982-1995, Part-time Instructor, Division of Continuing Education, University of Colorado, Boulder, CO. Instructor of introductory anthropology and physical anthropology classes.

1994-1995, Part-time Instructor, Department of Sociology, Anthropology, and Social Welfare, Metropolitan State College of Denver, Denver, CO. Instructor of introductory and upper level physical anthropology courses.

1994, Visiting Assistant Professor, Department of Sociology, Anthropology, and Social Welfare, Metropolitan State College of Denver, Denver, CO. Spring semester sabbatical replacement, instructed introductory and upper level archaeology and physical anthropology courses; coordinated departmental efforts to continue compliance with NAGPRA provisions; developed draft procedures for dealing with claims for the repatriation of College materials as per NAGPRA.

1990-1993, Part-time Instructor, Department of Sociology, Anthropology, and Social Welfare, Metropolitan State College of Denver, Denver, CO. Instructor of introductory and upper level physical anthropology courses.

1987-1992, Project Archaeologist, Archaeology Department, Powers Elevation Co., Inc., Aurora, CO. Duties included project administration and fieldwork direction for numerous small and medium scale survey and excavation projects in Colorado, Wyoming, South Dakota, North Dakota, Montana, and Kansas; co-field director of data recovery project at Monaghan Camp (SDV3041); laboratory director for curation and analysis of artifacts recovered during data recovery projects at SDV3017, SDV3041 and 5AH380; field supervisor during the archaeological survey and testing for the New Denver International Airport; report research, writing, editing, and production for projects in Colorado, Wyoming, and North Dakota; curation of artifacts from Colorado, Wyoming, Kansas, and North Dakota; excavation at site 5AH380,

Employment History, cont.:

Arapahoe County, Colorado; training of lab and field personnel; proposal and bid preparation.

1988-1989, Lecturer, Department of Anthropology, University of Colorado, Boulder, CO. Instructor of introductory anthropology classes.

1987, Part-time Instructor, Department of Sociology, Anthropology, and Social Welfare, Metropolitan State College of Denver, Denver, CO. Instructor of introductory and upper level physical anthropology courses.

1985-1986, Graduate Student Instructor, Department of Anthropology, University of Colorado, Boulder, CO. Supervised teaching assistants and instructed four introductory anthropology and physical anthropology classes.

1981-1984, Teaching Assistant, Department of Anthropology, University of Colorado, Boulder, CO. Six semesters assisting professors and instructing laboratory classes in physical anthropology.

1988, Archaeological Excavation, Western Cultural Resource Management, Sparks, NV. Served as crew member for the archaeological testing of historic site 48CR1210, Carbon County, Wyoming.

1985, Visiting Scientist, National Museum of Natural History, Smithsonian Institution, Washington, D.C. Conducted research on human skeletal collections.

1984, Archaeological Excavation, Western Cultural Resource Management, Sparks, NV. Served as crew member for the excavation of Archaic period sites in southwestern Wyoming.

1980, Assistant Laboratory Supervisor, Dolores Archaeological Project, Dolores, CO. Supervised the washing, sorting, cataloging, and curation of artifacts and special samples

Employment History, cont.:

collected in the excavation of various sites in southwestern Colorado; site excavation experience.

1979-1980, Research Assistant, Department of Anthropology, Southern Illinois University, Carbondale, IL. Assisted in the analysis of a skeletal collection from Barbados.

1979-1980, Archaeological Laboratory Technician Department of Anthropology, Southern Illinois University, Carbondale, IL., Carrier Mills Laboratory, Center for Archaeological Investigations, washed, sorted, and cataloged artifacts from Woodland and Mississippian period sites in southern Illinois.

Honors:

Metropolitan State College Alumni Association
Part-Time Faculty Excellence Award (1993)

University of Colorado, Graduate Student Fellowship
(1983-1984)

Professional Organizations:

American Association of Physical Anthropologists
Society for American Archaeology
Colorado Archaeological Society
Colorado Historical Society
Society for Systematic Biology

Council Positions:

Executive Secretary (1995-present), President (1995), Vice President (1994) and Board of Directors (1994-present), Colorado Archaeological Society.

Professional Advisor, Indian Peaks Chapter, Colorado Archaeological Society (1993-1996).

Cultural Resource Management Reports:

- 1995 Osteological Analysis of CHS Burial #97. Woodward-Clyde.
1995 Osteological Analysis of CHS Burial #98. Woodward-Clyde.
1995 Cultural Resource Inventory of the Mt. Sanitas Open Space and Related
Parcels, Boulder County, Colorado. Native Cultural Services.
1995 Sunshine Properties Easements and Trash Dump Area Cultural Resource
Inventory, Boulder County, Colorado. Native Cultural Services.
1994 Andreas NUPUD Cultural Resource Inventory, Boulder County, Colorado.
Native Cultural Services.
1994 Archaeological Testing of Sites 5MR204 and 5MR205, Morgan County,
Colorado. Native Cultural Services.
1993 Cultural Resource Inventory of Portions of the South Boulder Creek Open
Space, Boulder County, Colorado. Native Cultural Services.
1993 A Cultural Resource Inventory of Open Space Lands in the Vicinity of
Valmont and 57th Street, Boulder County, Colorado. Native Cultural
Services.
1993 A Brief History of the Dory Hill Cemetery, Gilpin County, Colorado.
Prepared for the City of Black Hawk, Colorado. (M)
1993 Cultural Resource Inventory of the Proposed US West Table Mesa
Exchange Buried Cable Route Across City of Boulder Open Space,
Boulder County, Colorado. Native Cultural Services.
1993 Cultural Resource Inventory of Three Improvement Locations at Loveland
Ski Area, Clear Creek County. Native Cultural Services.
1993 Cultural Resource Inventory of the Spill Area and Proposed Access, Clear
Creek County, Colorado. Native Cultural Services.
1993 Cultural Resource Inventory of the Boyd Small Tract, Clear Creek County,
Colorado. Native Cultural Services.
1993 Cultural Resource Inventory of the Doyle Small Tract, Clear Creek
County, Colorado. Native Cultural Services.
1993 The Carter Lake Burial: Excavations at 5LR42, Larimer County,
Colorado. Native Cultural Services. (With: Peter J. Gleichman).
1993 Cultural Resources Inventory of the Proposed Little Thompson/Central
Weld Filter Plant, Larimer County, Colorado. Native Cultural Services.
1993 Archaeological Testing of Four Sites Located on Excess Bureau of
Reclamation Lands in Morgan County, Colorado, Final Report. Native
Cultural Services.
1992 A Cultural Resource Reconnaissance of the Eddy Property, Boulder
County, Colorado. Native Cultural Services. (With: Peter J. Gleichman).
1992 Cultural Resource Inventory of the Pawnee Co-op Grazing Association
Improvement Areas, Pawnee National Grassland, Weld County, Colorado.
Native Cultural Services.



Cultural Resource Management Reports, cont.:

- 1992 Cultural Resource Survey of Four Fence Enclosure Locations on the Pawnee National Grassland, Weld County, Colorado. Native Cultural Services.
- 1992 Cultural Resource Inventory for the Proposed Chase Gulch Reservoir and Eureka Gulch Wetlands Mitigation Area, Gilpin County, Colorado. Native Cultural Services.
- 1992 A Cultural Resource Reconnaissance of the Dawson Property, Boulder County, Colorado. Native Cultural Services.
- 1992 The Wolford Mountain Reservoir Project: Results of Evaluative Testing at 11 Archaeological Sites near Kremmling, Grand County, Colorado. Powers Elevation Co., Inc.
- 1992 Littrell Land Exchange, Cultural Resources Inventory, Gilpin County, Colorado. Powers Elevation Co., Inc.
- 1992 Central City East Circuit Replacement Line, Cultural Resources Inventory, Clear Creek and Gilpin Counties, Colorado. Powers Elevation Co., Inc.
- 1992 Box Elder-Tate Hamlet (SDV3017): A Multi-component Habitation Site in Denver County, Colorado. Powers Elevation Co., Inc. (With: G. C. Tucker Jr. and M. J. Tate).
- 1992 Koch Hydrocarbon Company Chase Transportation Denver International Airport, 10" Fuel Pipeline, Site 5AM631 Testing, Adams County, Colorado. Powers Elevation Co., Inc.
- 1992 U.S. Department of the Army, Rocky Mountain Arsenal Headquarters Area Parking Lot and Driveway Improvements, Adams County, Colorado. Powers Elevation Co., Inc.
- 1992 Lame Deer East Project [F 37-2(3)42]: Additional Evaluative Testing at Site 24RB1586, Rosebud County, Montana. Powers Elevation Co, Inc. (With: Gregory S. Newberry).
- 1992 A Cultural Resources Inventory of the Denver International Airport Priority III Tracts, Denver County, Colorado. Powers Elevation Co., Inc. (With: Marcia J. Tate).
- 1991 Jordan Oil and Gas Company, #1-11 Jordan Federal Cultural Resources Inventory, Weld County, Colorado. Powers Elevation Co., Inc.
- 1991 A Cultural Resources Inventory for the US WEST Communications Penrose-Colorado Springs Buried Fiber Optic Cable Line, Fremont and El Paso Counties, Colorado. Powers Elevation Co., Inc. (With contributions by Thomas H. Simmons).

Cultural Resource Management Reports, cont.:

- 1991 A Cultural Resources Inventory of the Denver International Airport Priorities I & II Tracts, Denver County, Colorado. Powers Elevation Co., Inc. September 27. (With: Marcia J. Tate).
- 1991 US WEST Communications Parachute Exchange Cable Replacement Project Cultural Resources Inventory, Garfield County, Colorado. Powers Elevation Co., Inc.
- 1991 ORYX Energy Company Mazatlan Federal Unit Well Location and Access Cultural Resources Inventory, Garfield County, Colorado. Powers Elevation Co., Inc.
- 1991 US WEST Communications Basalt Exchange (C1-0714) Cultural Resources Inventory, Eagle and Pitkin Counties, Colorado. Powers Elevation Co., Inc.
- 1991 Koch Exploration Company West Buffalo Red River Unit #23-25 Well Location, Harding County, South Dakota. Powers Elevation Co., Inc.
- 1991 P & M Petroleum Management (Advantage Resources Corporation) #4-4 North Indian Creek Federal Cultural Resources Inventory, Fall River County, South Dakota. Powers Elevation Co., Inc.
- 1991 P & M Petroleum Management (Advantage Resources Corporation) #10-34 North Indian Creek Federal Cultural Resources Inventory, Fall River County, South Dakota. Powers Elevation Co., Inc.
- 1991 Carbondale Exchange Cable Replacement Project, Segments 6 through 9, Cultural Resources Inventory, Pitkin and Gunnison Counties, Colorado. Powers Elevation Co., Inc.
- 1991 Carbondale Exchange Cable Replacement Project, Segments 1 through 5, Cultural Resources Inventory, Pitkin County, Colorado. Powers Elevation Co., Inc.
- 1991 Horsetooth Reservoir South Shoreline Cultural Resources Inventory, Larimer County, Colorado. Powers Elevation Co., Inc. (With R. Laurie Simmons and Christine Whitacre).
- 1990 A Cultural Resources Inventory of the Buckley Air National Guard Base, Arapahoe County, Colorado. Powers Elevation Co., Inc. (With M. J. Tate, C. A. Harrison, R. L. Simmons, and C. Whitacre).
- 1990 A Cultural Resources Inventory of the Pine Ridge Ranch, Arapahoe County, Colorado. Powers Elevation Co., Inc. (With M. J. Tate).
- 1990 Muddy Creek Reservoir Project: A Cultural Resources Inventory in the Construction Impact Area at the Proposed Dam Site C, Grand County, Colorado. Powers Elevation Co., Inc.
- 1990 Horsetooth Reservoir North Shoreline Cultural Resources Inventory, Larimer County, Colorado. Powers Elevation Co., Inc. (With R. Laurie Simmons and Christine Whitacre).

Cultural Resource Management Reports, cont.:

- 1989 Meridian Oil Company #32-31 Federal, Cultural Resources Inventory, Moffat County, Colorado. Powers Elevation Co., Inc.
- 1989 Borrow Area #2, Cultural Resources Inventory, Garfield County, Colorado. Powers Elevation Co., Inc.
- 1989 Divide Creek Unit #50 (Access), Cultural Resources Inventory, Mesa County, Colorado. Powers Elevation Co., Inc.
- 1989 Divide Creek Unit #49, Cultural Resources Inventory, Mesa County, Colorado. Powers Elevation Co., Inc.
- 1989 Divide Creek Unit #48, Cultural Resources Inventory, Mesa County, Colorado. Powers Elevation Co., Inc.
- 1989 #14-31 Federal Cultural Resources Inventory, Moffat County, Colorado. Powers Elevation Co., Inc.
- 1989 Strat Land Exploration Cultural Resources Inventory Federal 2-12, Baca County, Colorado. Powers Elevation Co., Inc.
- 1989 A Cultural Resources Inventory of the Proposed WWD Line from Well #T68-11G to Well #T36-X-3G, and Borrow Area, Rio Blanco County, Colorado. Powers Elevation Co., Inc.
- 1989 A Cultural Resources Inventory of the Proposed Divide Creek Unit #52, Mesa County, Colorado. Powers Elevation Co., Inc.
- 1989 A Cultural Resources Inventory of the Proposed Divide Creek Unit #51, Mesa County, Colorado. Powers Elevation Co., Inc.
- 1989 A Cultural Resources of the Proposed Divide Creek Unit #58, Mesa County, Colorado. Powers Elevation Co., Inc.
- 1989 A Cultural Resources Inventory of the Proposed #1 Good Thing, Morton County, Kansas. Powers Elevation Co., Inc.
- 1989 A Cultural Resources Inventory of the Proposed East Burke Ranch Unit #15 Well Location and Access, Natrona County, Wyoming. Powers Elevation Co., Inc.
- 1989 A Cultural Resources Inventory of the Proposed East Burke Ranch Unit #16 Well Location and Access, Natrona County, Wyoming. For Powers Elevation Co., Inc.
- 1989 A Cultural Resources Inventory of the Proposed East Burke Ranch Unit #17 Well Location and Access, Natrona County, Wyoming. For Powers Elevation Co., Inc.
- 1989 A Cultural Resources Inventory of Four Road Segments in the Arapahoe National Forest, Clear Creek County, Colorado. Powers Elevation Co., Inc.
- 1989 Archaeological Studies at the New Denver International Airport. Powers Elevation Co., Inc. (With M.J. Tate, B.P. O'Neil and G.C. Tucker Jr.).

Cultural Resource Management Reports, cont.:

- 1989 A Class III Cultural Resources Inventory of the Amoco Elk Basin CO₂ Pipeline. Powers Elevation Co., Inc. (With G.S. Newberry, M.J. Tate, and P.D. Friedman).
- 1989 Cultural Resources Inventory of Betts Ranch, Douglas County, Colorado. Powers Elevation Co., Inc. (With M. Tate and P. Friedman).
- 1988 A Class III Cultural Resources Inventory of the Proposed Public Service Company of Colorado 230 kV Conversion Transmission Line, Cameo to Fruita Segment, Mesa County, Colorado. Powers Elevation Co., Inc. (With P.D. Friedman).
- 1988 Report on the Data Recovery Program at Site 5AH380 for the City of Aurora Senac Dam Project, Arapahoe County, Colorado. Powers Elevation Co., Inc. (With B. O'Neil, M. Tate and P. Friedman).
- 1988 Cultural Resources Inventory of the Proposed Fina Oil and Chemical Company 12-6 West Lilli Federal Well Pad and Access, Weld County, Colorado. Powers Elevation Co., Inc.
- 1988 Cultural Resources Inventory of the Proposed Fina Oil and Chemical Company 10-1 West Lilli Federal Well Pad and Access, Weld County, Colorado. Powers Elevation Co., Inc.
- 1988 Cultural Resources Inventory of the Proposed Fina Oil and Chemical Company 14-1 West Lilli Federal Well Pad and Access, Weld County, Colorado. Powers Elevation Co., Inc.
- 1988 A Class I Cultural Resources Literature Review for the Proposed Amoco Salt Creek Unit and Proposed CO₂ Pipeline Project. Powers Elevation Co. Inc. (With M.J. Tate, P.D. Friedman, J. Gooding & G.S. Newberry).
- 1988 A Class I Cultural Resources Literature Review for the Proposed Amoco Raptor Unit and Proposed CO₂ Pipeline Project. Powers Elevation Co., Inc. (With: M.J. Tate, P.D. Friedman, & G.S. Newberry).
- 1988 A Class I Cultural Resources Literature Review for the Proposed Amoco Little Buffalo Basin Unit and Proposed CO₂ Pipeline Project. Powers Elevation Co., Inc. (With: M.J. Tate, P.D. Friedman, J. Gooding & G.S. Newberry).
- 1988 A Class I Cultural Resources Literature Review for the Proposed Amoco Beaver Creek Unit and Proposed CO₂ Pipeline Project. Powers Elevation Co., Inc. January 5. (With: M.J. Tate, P.D. Friedman, J. Gooding & G.S. Newberry).



Publications:

Articles:

- 1996 Artifact Assemblages and Site Function: A Case Study Based on the Archaeological Testing of Four Sites in Morgan County, Colorado. *Southwestern Lore*, 62(4):20-37.
- 1994 The Carter Lake Burial: Excavations at 5LR42, Larimer County, Colorado. *Southwestern Lore*, 60(2):4-27. (With: P. Gleichman).
- 1988 Variation in the frequency of a notch in the short process of the incus in six different human skeletal populations. *International Journal of Anthropology*, 3:199-205.
- 1982 Osteology of a slave burial population from Barbados, West Indies. *American Journal of Physical Anthropology*, 59:171-192. (With: R. Corruccini, J. Handler and F. Lange).
- 1982 The statistical power of the Plains Anthropologist. *Plains Anthropologist*, 27(97):255-257. (With: S. Munson).
- 1982 Tooth mutilation in the Caribbean: Evidence from a slave burial population in Barbados. *Journal of Human Evolution*, 11:297-313. (With: J. Handler and R. Corruccini).
- 1980 Meat, markets and mechanical materialism: the protein fiasco in anthropology. *Dialectical Anthropology*, 5:171-192. (With P. Diener and K. Moore).

Abstracts:

- 1988 Anomalies and pathologies in human auditory ossicles. *Am. J. Phys. Anthropol.*, 75:252.
- 1986 Twenty years of Nubian skeletal research. *Am. J. Phys. Anthropol.*, 69:242-244.
- 1985 Functional aspects of human auditory ossicles as determined by principal component analysis. *Am. J. Phys. Anthropol.*, 66:208.
- 1984 Principal component analysis: size and shape or mathematical artifact. *Am. J. Phys. Anthropol.*, 63:197.
- 1983 Stature differences and sibship size; a comparison of college students and their parents. *Am. J. Phys. Anthropol.*, 60:213. (With A.J. Kelso and C. Nay).

Book Reviews:

- 1990 Review of Status and Health in Prehistory: A Case Study of the Moundville Chiefdom, Mary Lucas Powell, 1988, Smithsonian Institution Press. *Southwestern Lore* 56(2):40.

Robert J. Mutaw Vita
May, 1997, Page 11

Symposia Organized:

High Altitude Archaeology: A Research Symposium. Fifty-ninth Annual Meeting, Colorado Archaeological Society, October 28, 1994.

Nubian Skeletal Research: The Last Twenty Years and Perspectives for the Future. Fifty-fifth Annual Meeting, Am. Assoc. Phys. Anthropologists, April 12, 1986.

Invited Panelist:

Interdisciplinary Forensics: Integrating Anthropologists, Criminologists, Criminalists and the Legal Profession. Sponsored by Metropolitan State College of Denver and the University of Colorado at Denver, March 27, 1993.

Presented Papers:

High altitude archaeology in Colorado: An overview. High Altitude Archaeology: A Research Symposium, 59th Annual Meeting, Colorado Archaeological Society, Boulder, CO, October 29, 1993.

1992 excavations at site 5LR42: The Carter Lake burial. Contributed paper, 58th Annual Meeting, Colorado Archaeological Society, Telluride, CO, October 9, 1993.

Anomalies and pathologies in human auditory ossicles. Contributed paper, 57th Annual Meeting, Am. Assoc. Phys. Anthropologists, Kansas City, Missouri, March 25, 1988.

Twenty years of Nubian skeletal research. Nubian Skeletal Research Symposium, 55th Annual Meeting, Am. Assoc. Phys. Anthropologists, Albuquerque, NM, April 12, 1986.

Functional aspects of human auditory ossicles as determined by principal component analysis. Contributed paper, 54th Annual Meeting, American Assoc. Phys. Anthropologists, Knoxville, TN, April 11, 1985.

Principal component analysis: size and shape or mathematical artifact. Contributed paper, 53rd Annual Meeting, American Assoc. Phys. Anthropologists, Philadelphia, PA, April 12, 1984.

Stature differences and sibship size; a comparison of college age students and their parents. Contributed paper, 52nd Annual Meeting, American Association of Physical Anthropologists, Indianapolis, IN, April 7, 1983 (with A. Kelso and C. Nay).

The physical anthropologist as an expert witness. Informal Roundtable, 1st Annual Meeting, High Plains Section, Society for Applied Anthropology, Boulder, CO, February 21, 1981.

Presented Papers, cont.:

An evolutionary model explaining primate mammal consumption. Contributed Paper, 56th Annual Meeting, Central States Anthropological Society, Ann Arbor, MI, April 12, 1980.

The protein requirements of primates. Anthropology and the Protein Debate Symposium, 15th Annual Meeting, Southern Anthropological Society, Louisville, KY, March 21, 1980.

Teaching Experience:

University of Colorado, Boulder:

1030	Principles of Anthropology I	25 sections
1040	Principles of Anthropology II	11 sections
2010	Introduction to Physical Anthropology 1	12 sections
2020	Introduction to Physical Anthropology 2	11 sections
2030	Laboratory Methods in Physical Anthropology 1	3 sections
2040	Laboratory Methods in Physical Anthropology 2	1 section

Metropolitan State College of Denver:

101	Physical Anthropology and Archeology	8 sections
210	Human Evolution	5 sections
264	Archaeology	1 section
311	Human Variation	3 sections
315	Primate Studies	2 sections
498	Human Osteology - Independent Study	1 section
498	Osteological Research - Independent Study	1 section

Research Skills:

ARCHAEOLOGY: Field and laboratory methods.

QUANTITATIVE METHODS: Univariate and multivariate statistics.

COMPUTER SCIENCE: Computer programming, word processing, database, statistical packages, and spreadsheets, and Apple, MS-DOS, and Windows systems.

OSTEOLOGY: Identification and description of human skeletal remains, skeletal demography, dental metrics, and discrete traits.